

**PRELIMINARY DRAFT**  
**NATIONAL BUILDING CODE OF INDIA**  
**PART 11 APPROACH TO SUSTAINABILITY**

**BUREAU OF INDIAN STANDARDS**

## CONTENTS

### FOREWORD

- 1 SCOPE
- 2 TERMINOLOGY
- 3 APPROACH TO SUSTAINABILITY
- 4 APPLICABILITY OF THIS PART
- 5 IMPLEMENTATION OF THIS PART
- 6 SITING, FORM AND DESIGN
- 7 EXTERNAL DEVELOPMENT AND LANDSCAPE
- 8 ENVELOPE OPTIMIZATION
- 9 MATERIALS
- 10 WATER AND WASTE MANAGEMENT
- 11 BUILDING SERVICES OPTIMIZATION
- 12 CONSTRUCTIONAL PRACTICES
- 13 COMMISSIONING, OPERATION, MAINTENANCE AND BUILDING PERFORMANCE TRACKING

ANNEX A DESIGN STRATEGIES AS PER CLIMATE ZONES FOR VARIOUS SEASONS

ANNEX B PRESCRIPTIVE METHOD FOR ENVELOPE OPTIMIZATION

ANNEX C TRADE-OFF METHOD FOR ENVELOPE OPTIMIZATION

ANNEX D WHOLE BUILDING ANALYSIS METHOD FOR ENVELOPE OPTIMIZATION

**ANNEX E DATA COLLECTION TEMPLATE FOR EMBODIED ENERGY AND CARBON OF INDIAN CONSTRUCTION MATERIALS**

### LIST OF STANDARDS

## National Building Code Sectional Committee, CED 46

## FOREWORD

This Code (Part 11) covers the role of the building (and the built environment) towards sustainability. Sustainability could be perceived as the state of the living environment that concurrently ensures (promotes and nurtures - interdependency) societal and planetary health, supports equitable access to a safe and productive life (dignity, cultural values and aspirations), bolsters resilience to climate-change while also mitigating climate change.

~~parameters required to be considered for planning, design, construction, operation and maintenance of buildings and those relating to land development, from the point of view of sustainability.~~

From the dawn of civilization, our ancestors relied entirely on energy and resources derived from nature and thereby sensitive to her sustainability. With the paradigm shift towards development, industrialization and modernisation, the direct reliance on energy and resources derived from nature receded, with efforts primarily directed towards the sustenance of industrial growth and consumerism for want of a double-digit economic growth. While economic growth is one of the three crucial pillars supporting sustainability, by itself, its dominance alone causes imbalance in the other two pillars, thereby threatening sustainability.

~~were concerned with preservation and sustenance of environment.~~

The ancient *Vedas* have several references in them on environmental protection, ecological balance, weather cycle, rainfall phenomenon, hydrological cycle and related subjects. Seers, even at those times, recognized that changes caused due to indiscreet human activities could result in imbalances in seasons, rainfall patterns, crops and atmosphere and degrade the quality of water, air, and earth resources. Basham, in 'The Wonder that was India', describes how palaces in Mauryan dynasty in second century B.C., were exquisitely built from carved wood of local deodars. In later years the monasteries, temples and *dharmashalas* were built with locally available stones and these have withstood the ravages of time. Edwin Arnold, in 'The Light of Asia', describes *Vishramvan*, the palace built with local marble and alabaster for prince Siddharth. The epic Mahabharata describes palace built by Vishwakarma. *Kashi Vishwanath* Temple in Varanasi was built more than a thousand years ago. Many other ancient monuments in various parts of India are classic examples of sustainable buildings.

The *Taj Mahal*, built more than four hundred years ago, can accommodate hundreds of people with no suffocation, as the stone *jalis* in the facia induce air movement and enable natural ventilation. The fort in *Mandu* has elaborate rainwater harvesting techniques. *Havelis* in northern India were invariably built around a central courtyard, which brought

daylight to all nooks and corners, but the heat was kept out. Many forts and *havelis* have elaborate provision for evaporative cooling, using *khas*-screens and rainwater stored at higher plateaus. Sustainability and sustainable buildings have been the way of life in India.

It was not just palaces, monasteries and temples that were built on the platform of sustainable practices. The awareness was innate and intuitive, guided by a clear understanding of nature and driven by total alignment with environment, with the resolve not to harm nature but to respect and revere it, and to live in harmony with it. A reflection of this is visible in the locally evolved climate-responsive architecture that blended with social and cultural mores, leaving behind lasting concepts of building forms and human settlements. These buildings provided comfort to the occupants. They were passive in approach with no external intervention, which in modern times have become quite desirable. Diverse climatic conditions in our country resulted in evolution of different fabrics of built form, with the commonality being the focus on harmony with nature. It becomes obvious to see why all the scriptures, literature, life styles and cultural ethos made reference to the *Panchabhoothas*, which represent five elements of nature, thus blending the architecture and habitats with nature. Thus, sustainability, and sustainable buildings have been the way of life in India.

Less than a hundred years ago, industrial revolution came to India and changed many of these traditional sustainable practices in Indian buildings. The insatiable thirst for progress and comfort at any cost, altered the equation with nature forever. Concrete, steel, glass and later plastics became the dominant construction materials, beyond stone and wood of yesteryears. Power supply, artificial lighting, water supply and disposal, and thermal environmental control within built environment, were desired and obtained.

The new civilizations grew along the river banks, always regarding rivers as sacred. With the industrial revolution, untreated water, effluents from chemical industries and organic waste were discharged into rivers and water bodies, destroying our precious sources of water for domestic use. In addition, the unsustainable development and usage of buildings have led to huge construction and demolition waste, and municipal solid waste during their operation, which today have become a major problem.

Modern buildings in India consume about 25 to 30 percent of total energy, and up to approximately 30 percent of fresh potable water, and generate approximately 40 percent of total waste. India is now entering the phase of rapid urbanization. Various studies indicate that by 2050, the built up area of India may become four times the current mass, which may pose a major challenge in preserving our fragile environment. Although the present energy consumption per capita in India is a fraction of that of most developed nations, but with its projected growth, unless enough measures are taken, it is bound to lead to accelerate rate of environment degradation, contributing to increased emissions, carbon footprint leading to global warming and climate change, resource scarcity and inequitable development.

Article 51A (f, g) of the Constitution of India, on Fundamental Duties of every citizen of India states, 'to value and preserve the rich heritage of our composite culture', and 'to protect and improve the natural environment including forests, lakes, rivers, wild life and to have compassion for living creatures'. Article 21 (right to life), imbibes the 'right to a clean and health environment' as a fundamental right, including the most recent April 2024 ruling by the Supreme Court on 'right against climate change' as a fundamental right, noting that "without a clean environment which is stable and unimpacted by the vagaries of climate change, the right to life is not fully realized".

The UN Human Rights Council on 8<sup>th</sup> Oct' 2021 and the UN General Assembly on 28<sup>th</sup> July 2022, passed the overwhelming resolution to "the (universal) human right to a clean, health and sustainable environment".

Sustainable buildings have demonstrated reduction in energy and water consumption to less than half of the present consumption in conventional buildings and complete elimination of the construction and operational waste through recycling. The Indian way of life is *Aparigraha* (minimum possession), conservation (minimum consumption) and recycling (minimum waste). These three attributes are the guiding principles for sustainable buildings as well. With these attributes and its rich heritage, India can make a substantial contribution in this field and eventually lead the world on the path of sustainability.

Developed nations' approach to sustainability generally concentrates on energy efficiency through high technology innovations, and use of products, materials and designs with lower embodied energy. Their green ratings are based on intent, which implies expert inputs and simulation which often can be counter intuitive such as the envisaged load and effective use of energy efficient appliance. Indian construction industry will do better through use of products, materials and designs with lower embodied energy and our traditional wisdom and practices, building in harmony with nature through regional common knowledge, consuming as little as necessary, applying low cost technology innovations, using recycled materials, and recognizing performance (not intent) through easily measurable parameters, wherever feasible. If required, the above approach may be supplemented with an appropriate blend of the emerging and sustainable technology innovations. It is particularly emphasized that the hazard of construction and demolition waste should be properly attended to in view of increased construction and redevelopment activities in the country anticipated in future. This would require that such waste is preferably used at site and the balance, if any, may be sent to recycling plant which is closest to the site.

The Sectional Committee, reviewed the contents of the 2005 version of the Code and observed that due consideration had been given to these important dimensions in building planning, design and construction and during operation through provisions of effective utilization of natural light and ventilation; increased use of renewable energy, material selection including recyclability and reusability aspects; use of low gestation plantations

and agriculture and industrial wastes; design approach; proper management practices; efficient electrical and other building services and plumbing services; energy conservation; rainwater harvesting, etc. All these have been duly interwoven throughout the Code addressing both the embodied energy and the operational energy involved, as also showing sensitivity towards the concerns such as ozone depletion, global warming, etc. The Committee, however, felt that in keeping with the present needs as well as likely future scenario, it might be appropriate to completely review all such aspects and give them a special and separate identity in the form of Part of the Code covering approach to sustainability relating to buildings and built environment. Aiming towards such objectives, the Sectional Committee first formulated this Part and incorporated in the 2005 version of the Code through Amendment No. 1 to the Code.

The 2016 revision was taken up to further review this Part and update it particularly in view of the modifications that were being incorporated in other Parts/Sections in the 2016 revision of the Code, to bring coherence among the provisions of this Part and other revised Parts/Sections. The significant modifications incorporated in the 2016 revision were: Inclusion of definitions of a number of additional terms such as surface coefficient, surface resistance, thermal transmission and total thermal resistance; Greater emphasis on ensuring barrier free design for universal accessibility, as part of approach to sustainability; Review of provisions on materials and technologies for sustainability and their updating, wherever required; Inclusion of guidelines for selection of window types; Modification of the clause on refrigerants for air conditioning to include refrigerants, considering sustainability aspects; Inclusion of provision for preparation of overall water balance chart, as part of water and waste management.

A data collection template for embodied energy and carbon of Indian construction materials has been included in informative Annex E.

In alignment with the evolving demands of sustainability and resilience, this edition of the Part 11 of NBC incorporates significant updates to address contemporary challenges and improve its applicability across the built environment.

a) The scope of this Part has been thoroughly reviewed and updated to respond to emerging challenges, including climate change, ecological disruption, and the pervasive issue of widespread toxicity in materials and systems.

b) Clause 3, titled Approach to Sustainability, has been enhanced to reflect the latest practices and methodologies that support sustainable development.

c) Clause 9 on Materials has undergone a comprehensive revision, now including detailed provisions on environmental impact categories, life cycle stages, whole-building life cycle assessment (LCA) methodology, LCA tools, and guidelines for environmental declarations and disclosures. These updates aim to promote transparency and accountability in material selection and usage.

d) The provisions related to Lifts, Escalators, and Moving Walks have been updated to integrate advancements in technology, safety measures, and energy efficiency.

e) A dedicated data collection template for assessing the embodied energy and carbon footprint of Indian construction materials has been included to encourage data-driven decision-making and facilitate sustainable material sourcing.

f) References to all the concerned Indian standards have been updated.

This Part of the Code provides a comprehensive set of requirements, intended to reduce the negative impact of buildings on the natural environment. It can be readily used by the owners, developers/builders, architects, engineers, building services engineers and other building professionals as well as by manufacturers of building materials apart from the Authorities concerning land and building development, government and private construction agencies and academic and research institutions. The intent of this Part of the Code is to highlight sustainability measures including those referred to in different Parts/Sections of the Code as may be required as well as to define comprehensive sustainability standards for the building construction and related built environment.

The approach to sustainability is founded on principles consistent with this Code, to adequately protect public health, safety and welfare and to provide requirements that do not unnecessarily increase construction cost nor restrict the use of new / innovative materials, products or methods of construction. The benefits of incorporating measures listed in this Part are not only environment friendly, but also result in much better health and productivity of occupants, at minimal additional initial cost over the cost of conventional buildings, while substantially reducing the life cycle cost. This minimal additional cost is offset during a few years usage of the buildings, and vast advantage in cost is accrued during the life cycle of the building.

The measures of sustainable buildings described in this Part, set performance thresholds and incorporate features that allow Authority to customize requirements according to local geographical conditions, environmental priorities and agenda. These are not specific to any rating system and are not intended to provide a single metric indication of overall building performance. The flexibility of these provisions allows the practitioners to easily exercise their judgment in holistically and objectively applying the underlying principles of sustainability to a development or building facility, considering its functionality and required comfort level.

The provisions of this Part of the Code are without prejudice to the concerned statutory provisions including those given in various Acts and Rules and Regulations framed thereunder.

The information contained in this Part has been brought in coherence with the provisions contained in other parts of the Code, as also with the concerned Indian Standards on various areas. In the formulation of this Part, efforts have been made to take into cognizance the various latest applicable practices followed in the country and abroad,

relevant to sustainability in buildings. This has been done by taking into consideration the publications of the American Society for Heating, Refrigeration, Air conditioning Engineers; American Society for Testing and Materials; Bureau of Energy Efficiency, India; Indian Green Building Council; Indian Society for Heating, Refrigeration, Air conditioning Engineers; International Organisation for Standardisation; and The Energy and Resources Institute, India.

All standards cross-referred to in the main text of this Part, are subject to the revision. The parties to agreement based on this Part are encouraged to investigate the possibility of applying the most recent editions of the standards.

For the purpose of deciding whether a particular requirement of this Part is complied with, the final value, observed or calculated, expressing the result of a test or analysis, shall be rounded off in accordance with IS 2 : 2022 'Rules for rounding off numerical values (*second revision*)'. The number of significant places retained in the rounded off value should be the same as that of the specified value in this Part of the Code.



# NATIONAL BUILDING CODE OF INDIA

## PART 11 APPROACH TO SUSTAINABILITY

### 1 SCOPE

**1.1** This Part 11 covers the perspective of sustainability and the role of the built environment, keeping in mind emerging challenges such as climate-change, ecological disruption and wide-spread toxicity (endocrine disruptors, forever chemicals, micro/nano plastics, etc.). parameters required to be considered for planning, design, construction, operation and maintenance of buildings and those relating to land development, from sustainability point of view.

**1.2** This Part of the Code is a supplement to all other Parts/Sections of the Code and shall be read along with the same.

**1.3** For all buildings and facilities open to and used by the public, including all forms of public housing by the government/civic bodies and private developers, safe and barrier free access and movement within and around buildings, for persons with disabilities and of different age groups, shall be ensured in accordance with Part 3 'Development Control Rules and General Building Requirements' of the Code. Safety not only includes physical concerns but also those considerations (such as emissions/contact-chemicals) that could pose an acute and/or chronic threat to societal health and ecosystem services.

### 2 TERMINOLOGY

**2.0** For the purpose of this Part of the Code, the following definitions given below shall apply.

**2.1 Adaptive Thermal Comfort** – The comfort that relates indoor design temperatures or acceptable temperature ranges to outdoor meteorological and climatological parameters.

NOTE – The adaptive thermal comfort model refers to the concept of specifying indoor comfort temperature set points based on the physiological, behavioural and psychological measures that the occupants take, voluntarily or involuntarily, to adapt themselves to the thermal environment and achieve comfort.

**2.2 Authority Having Jurisdiction** – The Authority which has been created by a statute and which, for the purpose of the Code/Part, may authorize a committee or an official or an agency to act on its behalf; herein after called the 'Authority'.

**2.3 Biodiversity** – The variability among living organisms from all sources including terrestrial, marine and other aquatic ecosystems and the ecological complexes of which they are a part; this includes diversity within species, between species, and of ecosystems.

**2.4 Building Environment** – The surrounding in which a building operates, including air, water, land, natural resources, flora, fauna, human beings and their inter-relations.

**2.5 Building Performance** – The ability of a building to fulfil required functions under intended use conditions or behaviour when in use.

**2.6 Built Environment** – The collection of man-made or induced physical objects located in a particular area or region.

NOTE – When treated as a whole, the built environment typically is taken to include buildings, external works (landscape areas), infrastructure and other construction works within the area under consideration.

**2.7 Decarbonisation** – It refers to the process of reducing carbon dioxide (CO<sub>2</sub>) emissions resulting from human activity, with the ultimate goal of achieving a low-carbon or net-zero footprint.

**2.7.1 Decarbonisation of Built Environment** – It refers to the process of reducing or eliminating the carbon dioxide (CO<sub>2</sub>) emissions associated with the construction, operation, and maintenance of Built Environment. This process encompasses several strategies aimed at making buildings more energy-efficient, using low-carbon materials, and incorporating renewable energy sources.

**2.8 Disaster** – It is a catastrophe, mishap, calamity or grave occurrence in any area, arising from natural or man-made causes, or by accident or negligence which results in substantial loss of life, or human suffering or damage to, and destruction of, property or damage to or degradation of environment, and is of such a nature of magnitude as to be beyond the coping capacity of the community of the affected area.

**2.9 Ecological Footprint** – The impact of a person or community, expressed as the amount of land required to sustain their use of natural resources.

**2.10 Ecosystem** – The community of biological organisms and their physical environment, functioning together as an interdependent unit within a defined area.

NOTE – For the purpose of this definition, humans, animals, plants, and microorganisms are individually all considered biological organisms.

**2.11 Embodied Energy** – The sum total of energy that is used to extract, process, package, transport, and install the material in the building.

NOTE – Embodied energy data is often collected using input and output analysis.

**2.12 Emissivity(E)** – The ratio of rate of heat emitted by a surface as compared to that of an absolutely black surface under similar conditions. It varies with the temperature of the emitting surface.

**2.13 Environmental Impact** – Any change to the environment, whether adverse or beneficial, wholly or partially, resulting from environmental aspects of a built environment.

**2.14 Green Roof System** – An assembly that supports an area of planting/landscaping, built up on a waterproofed substrate at any level that is separated from the natural ground by a human made structure.

**2.15 Heat Island Effect** – A phenomenon in which air and surface temperature of an area are higher than nearby areas due to the replacement of natural land cover with pavement, building, and other infrastructure.

**2.16 Horizontal Sun Angle (HSA)** – The horizontal angle between the normal of the window and the sun azimuth angle at a given time (see Fig. 1).

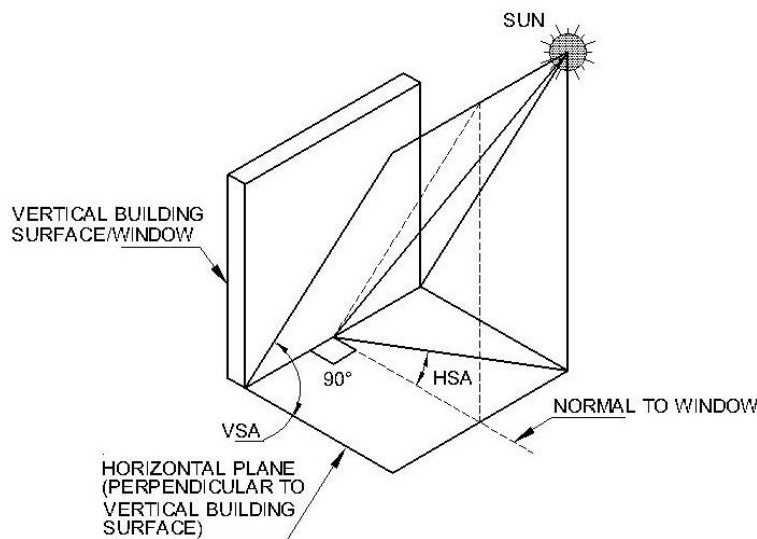

FIG. 1 HORIZONTAL AND VERTICAL SOLAR ANGLE FORMULATION

**2.17 Indoor Air Quality (IAQ)** – The nature of indoor air that affects the health and well-being of building occupants.

**2.18 Indoor Environment Quality (IEQ)** – The condition or state of the indoor environment.

**2.19 Life Cycle Assessment (LCA)** – A method of evaluating a product by reviewing the ecological impact over the life of the product.

NOTE – At each stage, the product and its components are evaluated based upon the materials and energy consumed, and the pollution and waste produced. Life stages include extraction of

raw materials, processing and fabrication, transportation, installation, use and maintenance, and reuse/recycling/disposal.

**2.20 Light Shelf** – An architectural element that allows daylight penetration in a building. It is usually a horizontal light-reflecting overhang on a window or opening and is placed above eye-level and has a high-reflectance upper surface. This surface reflects daylight onto the ceiling and deeper into a space.

**2.21 Non-renewable Resource** – A resource that exists in a fixed quantity that cannot be replenished on a human time scale.

NOTE – Non-renewable resources have the potential for renewal only by the geological, physical and chemical processes taking place over hundreds of millions of years. Non-renewable resources exist in various places in the earth's crust. Examples include iron ore, coal, and oil.

**2.22 Renewable Resource** – A resource that is available naturally, harnessed, and can be replenished.

NOTE – Sustainable use of renewable resource implies that the rate of replenishment, or cleansing takes place at a rate equal to or greater than the current rate of depletion of that resource. Examples include trees in forest, grasses in grassland, and fertile soil.

**2.23 Reuse** – Using a material, product or component of the waste stream in its original form more than once.

**2.24 Recycling** – A process to convert discarded materials that would otherwise become waste, into valuable resources.

**2.25 Skylight Roof Ratio (SRR)** – The ratio of the total skylight area of the roof, measured to the outside of the frame, to the gross exterior roof.

**2.26 Solar Heat Gain Coefficient (SHGC)** – The fraction of incident solar radiation admitted through a fenestration, both directly transmitted, and absorbed and subsequently released inward through conduction, convection and radiation (see Fig. 2).

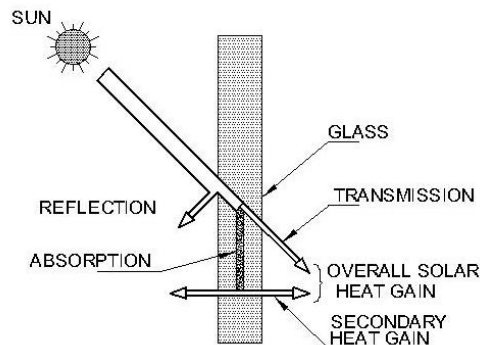

FIG. 2 MECHANISM OF SOLAR HEAT GAIN

**2.27 Solar Reflectance Index (SRI)** – A measure of material’s ability to reject solar radiation, as shown by a small temperature rise.

NOTE – SRI of standard black surface (having reflectance of 0.05 and emittance of 0.9) and a standard white surface (of reflectance 0.8 and emittance 0.9) are taken as 0 and 100, respectively.

**2.28 Surface Coefficient ( $f$ )** — The thermal transmission by convection, conduction and radiation from unit area of the surface, for unit temperature difference between the surface and the surrounding medium. It is expressed in  $W/m^2 K$ .

NOTE – The value of  $f$  depends on many factors, such as, air or fluid movement in contact with the surface, roughness and emissivity of the surface and upon the temperature and nature of surroundings.

**2.29 Surface Resistance ( $1/f$ )** — The reciprocal of surface coefficient. It is expressed in  $m^2K/W$ .

**2.30 Sustainability** – The state in which components of ecosystem and their functions are maintained for the present and future generations.

#### NOTES

- 1 Sustainability is the goal of sustainable development and can result from the application of the concept of sustainable development.
- 2 In building construction, it relates to how the attributes of the activities, materials/products or services used in construction work, or the use of construction works, contribute to the maintenance of ecosystem components and functions for future generations.
- 3 While the challenge of sustainability is global, the strategies for sustainability in building construction are local and may differ in context and content from region to region.
- 4 ‘Components of ecosystem’ includes plants and animals, as well as humans and their physical environment. For humans, this includes a balancing of key elements of human needs namely the economic, environmental, social and cultural conditions for societies’ existence.

**2.31 Sustainable Buildings** – A building that meets the specified building performance requirements while minimizing disturbance to and improving the functioning of local, regional, and global ecosystem both during and after its construction and specified service life.

NOTE – A sustainable building optimizes efficiencies in resource management and operational performance; and, minimizes risks to human health safety and the environment.

**2.32 Sustainable Development** – The development that meets the need of the present without compromising the ability of future generations to meet their own.

**2.33 Thermal Absorptivity** – A factor indicating the relative amount of radiation absorbed by a surface as compared to an absorbing black body under the same conditions. Its value is dependent upon the temperature of the source and of the receiving surface.

**2.34 Thermal Capacity** – The amount of heat necessary to raise the temperature of a given mass by  $1\text{ }^\circ\text{C}$ . Numerically, the thermal capacity per unit area of surface is the sum

of the products of the mass per unit area of each individual material in the roof, wall or floor surface multiplied by its individual specific heat.

**2.35 Thermal Conductance ( $R$ )** – The thermal transmission of a single layer structure per unit area divided by the temperature difference between the hot and cold faces. It is expressed in  $W/m^2 K$ .

NOTE – Thermal conductance is a measure of the thermal transmission per unit area through the total thickness of the structure under consideration. Thermal conductivity on the other hand refers to unit thickness of material. Further, this term applies only to a single layer of material and not to a composite insulation or to a structure made up of several layers of materials or medium.

**2.36 Thermal Conductivity ( $k$ )** – The quantity of heat in the steady state conditions flowing in unit time through a unit area of a slab of uniform material thickness of infinite extent and of unit thickness, when unit difference of temperature is established between its faces. Its unit is  $W/mK$ .

NOTE – Thermal conductivity is a characteristic property of a material and its value may vary with a number of factors, including density, porosity, moisture content, fibre diameter, pore size, type of gas in the material, mean temperature and outside temperature range. The conductivity value varies from  $0.03 W/mK$  for insulators to  $400 W/mK$  for metals. Materials with lower conductivity are preferred, as they are better insulators and reduce the external heat gains from the envelope or loss of internal heat to outside cold environment.

**2.37 Thermal Comfort** – That condition of mind which expresses satisfaction with the thermal environment and is assessed by subjective evaluation.

**2.38 Thermal Reflectivity**– The ratio of the reflected heat to that of the total heat incident on a surface at a certain mean temperature range.

**2.39 Thermal Resistance ( $R$ )** – The reciprocal of thermal conductance. For a structure having plane parallel faces, thermal resistance is equal to thickness ( $L$ ) of the structure divided by thermal conductivity ( $k$ ).

$$R = \frac{L}{k}$$

NOTE – The usefulness of the quantity is that when heat passes in succession through two or more components of the building units, the resistance may be added together to get the total resistance of the structure.

**2.40 Thermal Resistivity ( $1/k$ )** – The reciprocal of thermal conductivity. It is expressed in  $mK/W$ .

**2.41 Thermal Transmission or Rate of Heat Flow ( $q$ )** – The quantity of heat flowing in unit time under the conditions prevailing at that time. Its unit is  $W$ .

**2.42 Thermal Transmittance ( $U$ )** – Thermal transmission through unit area of the given building unit divided by the temperature difference between the air or other fluid on either

side of the building unit in steady state conditions. It is also called as  $U$ -value. Its unit is  $W/m^2K$ .

NOTE – Thermal transmittance differs from thermal conductance in so far as temperatures are measured on the two surfaces of a material or structure or building unit in the latter case and in the surrounding air or other fluid in the former case. Thermal conductance is a characteristic of the structure or building unit whereas thermal transmittance depends on conductance and surface coefficients of the structure or building unit under the conditions of use.

**2.43 Total Thermal Resistance ( $R_T$ )** — It is the sum of the surface resistances and the thermal resistance of the building unit itself. It is expressed in  $m^2K/W$ .

**2.44 Tropical Summer Index (TSI)** – The temperature of calm air at 50 percent relative humidity which imparts the same thermal sensation as the given environment. TSI (in  $^{\circ}C$ ) is expressed as:

$$TSI = 0.745t_g + 0.308t_w - 2.06\sqrt{v} + 0.841$$

where

$t_g$  = globe temperature,  $^{\circ}C$ ;  
 $t_w$  = wet bulb temperature,  $^{\circ}C$ ; and  
 $v$  = wind speed, m/s

**2.45 Vertical Solar Angle (VSA)** – The angle that a plane containing the bottom two points of the window and the centre of the sun makes with the ground when measured normal to the shaded surface (see Fig. 1).

**2.46 Visual Light Transmittance (VLT)** – The ratio of total transmitted light to total incident light.

**2.47 Volatile Organic Compound (VOC)** – The carbon compounds (excluding carbon monoxide, carbon dioxide, carbonic acid, metallic carbides or carbonates, and ammonium carbonate) which participate in atmospheric photochemical reactions. The compounds vapourize at normal room temperatures.

**2.48 Waste** – Substances or objects which the holder intends or is required to dispose of.

### 3 APPROACH TO SUSTAINABILITY

The living environment (commonly referred to as 'environment') comprises the natural and the built environment. The natural environment comprises the planetary systems (and boundaries), including ecology and biodiversity, providing the essential ecosystem services that sustains modern society. The built environment comprises man-made structures, leveraging scientific and technological advancements, to accommodate the multitude of societal lifestyles, reflecting societal aspirations, cultural values and virtues. Traditional habitations (cultures, dwellings, energy, food) prior to industrialization, relied

entirely on natural resources and ecosystem services, predating the emerging paradigm 'nature based solutions', these habitations evolved intimately connected with nature, were inherently stable and sustainable.

With the advent of industrialisation and development relying on consumerism (economic growth), modern society set-forth unprecedented transformations in the built environment. These transformations predominantly shunned traditional wisdom as primitive, and progressively disregarded the interconnectedness and interdependencies amidst the natural process that balanced and regulated the earth's biosphere to sustain life. Consequently, numerous disruptions have emerged in the planetary processes, destabilizing climatic, hydrological, terrestrial and oceanic systems. While about 7% annual reduction in global emissions is required (~2030) to remain within 1.5°C global warming, the emissions are actually on a 1.5% rise. Further, unregulated waste dispersal and migration has resulted in micro/nano-plastic contamination in all natural process and permeation of forever chemicals and other endocrine disruptors in every living tissue in the biosphere. The intricate relationships between climate change, land use, and biodiversity are best understood through a visual representation, as shown in Fig. 3, which highlights their interconnectedness and interdependency.



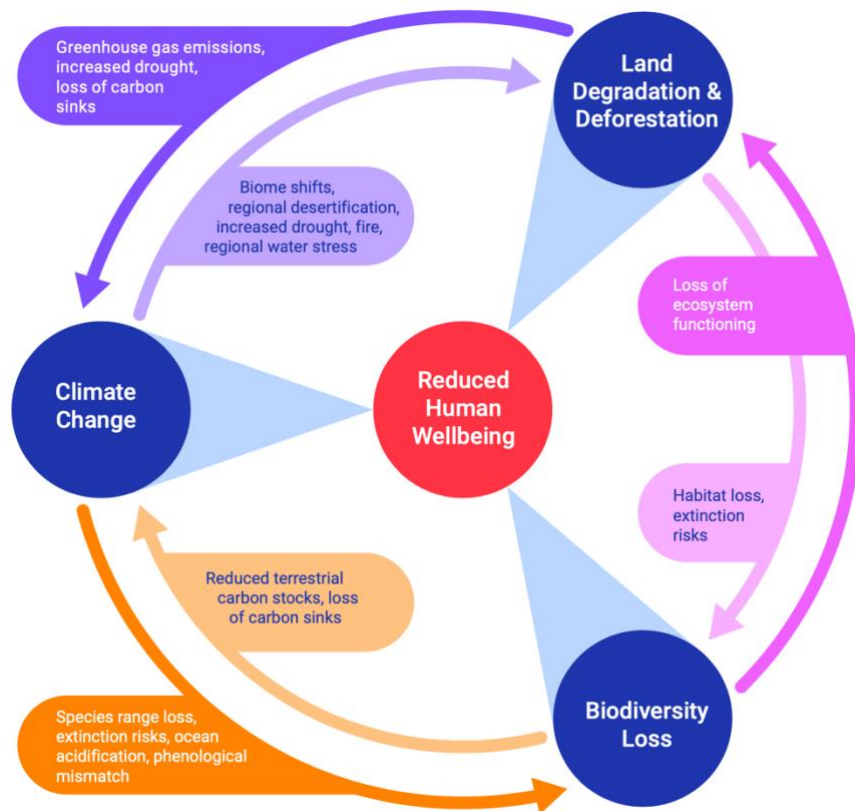
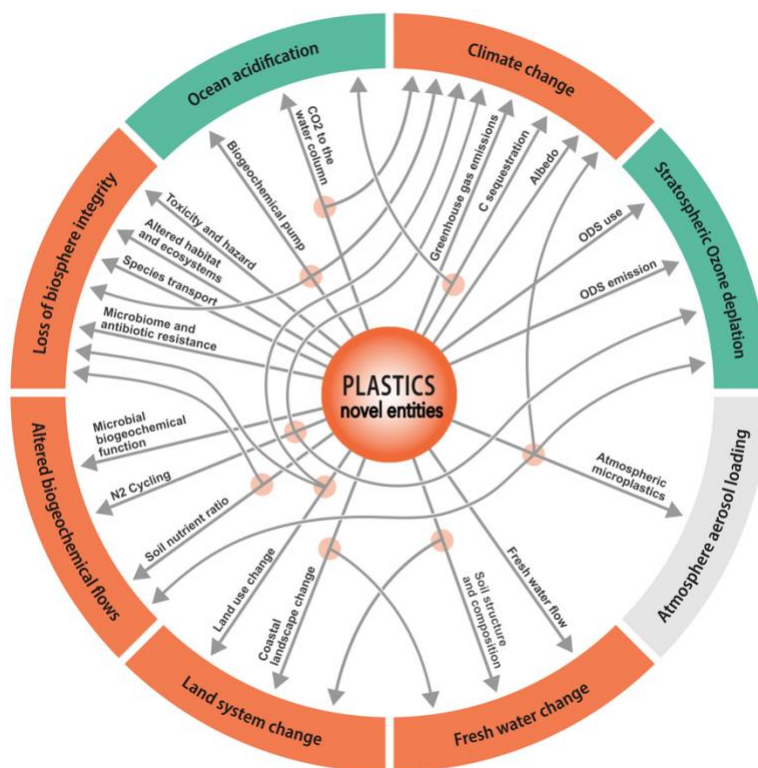

**FIG. 3 ILLUSTRATING THE INTERCONNECTEDNESS AND INTERDEPENDENCY BETWEEN CLIMATE CHANGE, LAND-USE AND BIODIVERSITY**

As it stands, the built environment contributes to approximately 40 percent of global CO<sub>2</sub> emissions, both embodied and operational, with India's embodied building-material emissions is expected to nearly triple by 2050 (800 MT CO<sub>2</sub>) from 2015 emissions, with a 5 times and 8 times increase in urban residential and commercial floor space between 2015 to 2050. Energy use intensity for commercial and residential buildings is expected to increase by almost 100 percent to about 130 kWh/m<sup>2</sup> and by nearly 50 percent to about 90 kWh/m<sup>2</sup> respectively from 2015 levels.

Besides the occurrence of microplastics in the human placenta and blood vessels, and plant tissue and larvae of insects, they have been found in atmospheric clouds impacting their formation and behaviour. Plastic pollution has been found to impact all the planetary boundaries that regulate and balance natural processes in the biospheres (see Fig. 4). Nearly every feature of the built-environment needs to be re-examined for its contribution to environmental toxicity, for example, fire-retardants, intended for safety, comprise forever chemicals and are carcinogenic. An emerging threat to the biosphere's sustainability includes the synergistic impact involving microplastics and forever chemicals, few among them being increase in antibiotic resistance and soil-infertility.

Climate-change, microplastics and forever chemicals are anthropogenic contributions that have set off the planetary debacle threatening sustainability of life as we know it.



**FIG. 4 ILLUSTRATING THE IMPACT OF PLASTIC POLLUTION EXACERBATING IMPACTS OF ALL THE PLANETARY BOUNDARIES**

Besides India being the third, globally, in terms of global emissions, it also ranks third in cancer incidence, with one in nine people likely to be diagnosed with cancer in their lifetime. A well-established correlation between increased cancer rates and increased GDP is telling of the prevalent malefic undercurrents. Widespread toxicity in the living environment, stress and discontent, breakdown in social enrichment, disconnect from nature, poor lifestyle and diet are a combination of factors perpetrating ill-health in society. Studies into happiness and economic progress in modern society have revealed that while there has been a per capita increase in income, it has essentially not ensured a happier society nor are individuals leading meaningful lives. On the social front, the disparity in material footprint (supporting domestic consumption) by country income (2017) varies from about 4 tonnes per capita to about 28 tonnes per capita for high income states. Widespread disparity (aspirational reluctance and discontent) amidst various stakeholders in society, limits any unified involvement and efforts to achieve sustainability. The built environment evolves to reflect these unsustainable realities in

society, including human-induced environmental degradation that impedes achieving Sustainable Development Goals (SDGs) (see Fig. 5). A transformation is thus required, with a clean, safe and inclusive living environment serving as a means and end in achieving sustainability.

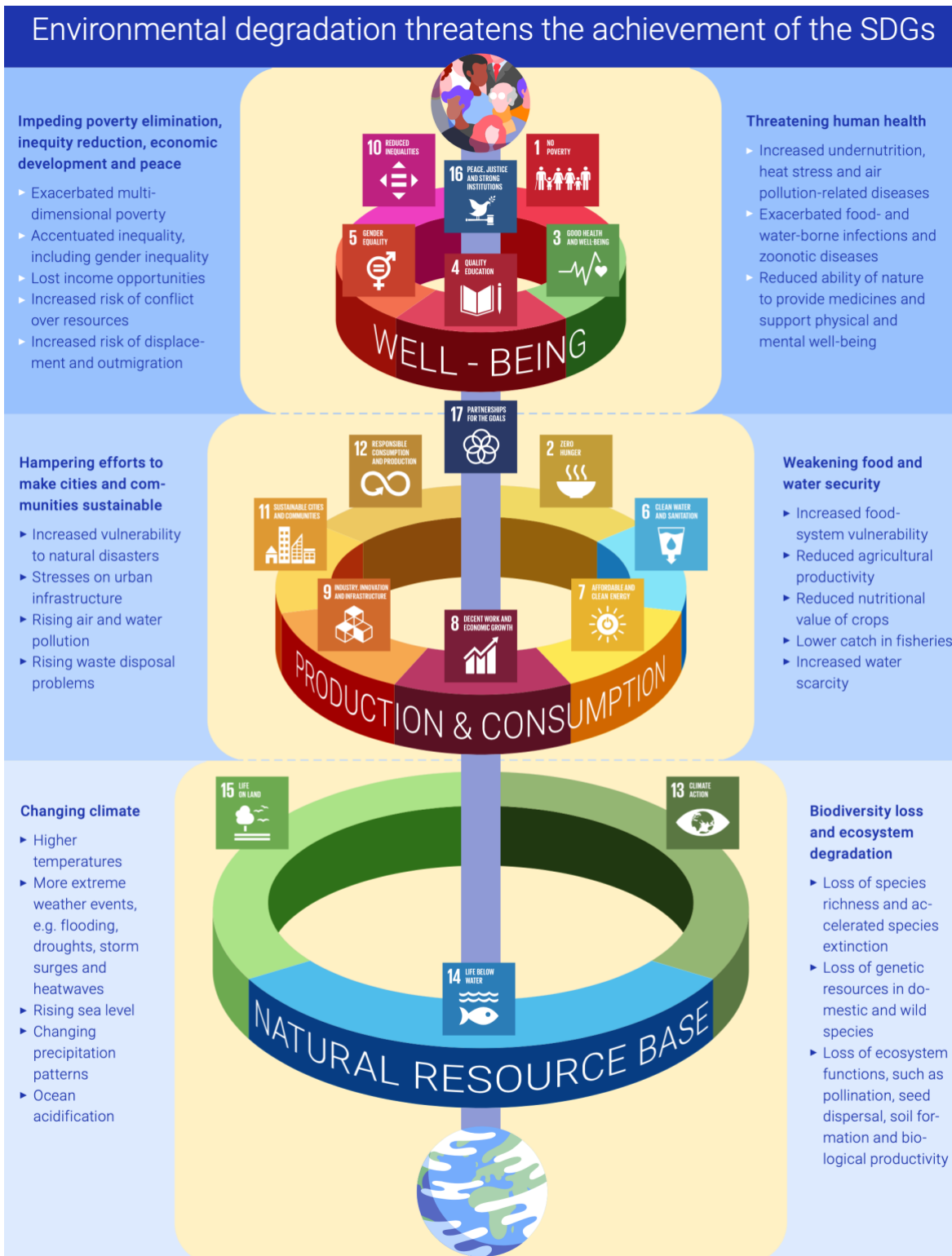
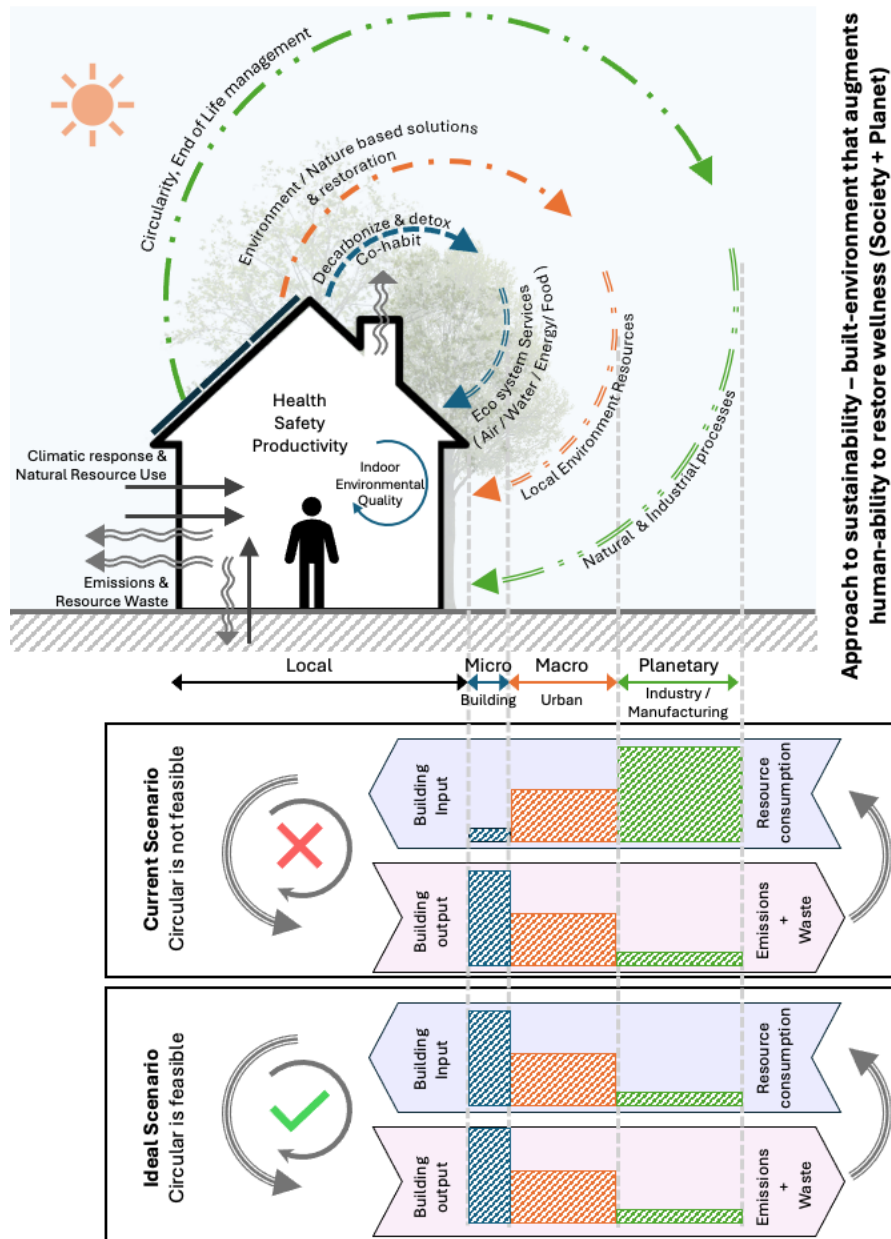

Figure ES.1: Selected environmental changes and related impacts on the SDGs. The clustering of SDGs provides an integrated perspective with the environment as the foundation for the economy, human development and, ultimately, human well-being. Human-induced environmental degradation adversely impacts human well-being.

**FIG. 5 ILLUSTRATING THE DEPENDENCY OF HUMAN WELL-BEING ON THE ENVIRONMENT**

### 3.1 Role of the built environment (and buildings) in Sustainability

Buildings serve the fundamental functionality of 'safety' which is a crucial requirement of safety. Safety in buildings translates to an indoor and outdoor environment that ensures physical and mental health for a productive and meaningful life, protection from adverse climatic elements and exposure to toxicity, personal security, promoting socialization and bonding with nature. It is this safety that needs to be re-examined for every functional performance derived from buildings and reasserted for societal and planetary wellness.



## FIG. 6 ILLUSTRATING THE ROLE OF THE BUILT ENVIRONMENT AMIDST THREE OPERATIONAL SCALES, THE MICRO-CLIMATE, THE MACRO (URBAN) SCALE AND THE PLANETARY SCALE

As illustrated in the fig. 6 above, buildings connect with the immediate climatic and environmental conditions (micro-climate) and traditionally relied on local resources, which were easily replenished as the constituents were predominantly unprocessed. The integration of exotic and/or industrialised resources were minimal. Circularity was thus naturally operational at three scales, micro, macro and planetary (ideal scenario). However, modern dwellings rely extensively on industrialized produce that derives resources from diverse geographies, for example more than 15 countries are involved in the manufacture of a simple mobile phone. The waste generated is thus not amenable with local ecosystem services and with unregulated disposal contributes to widespread environmental degradation and contamination (current scenario).

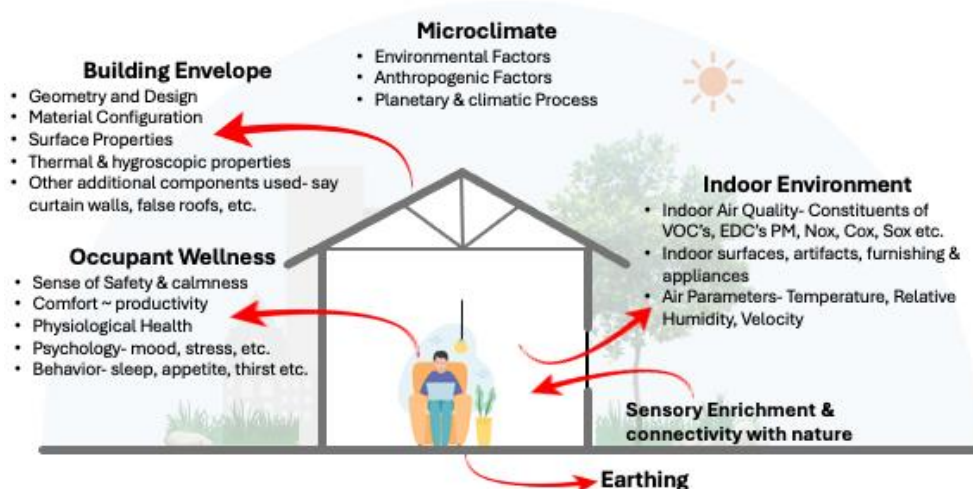

## FIG. 7 ILLUSTRATING VARIOUS FUNCTIONALITIES DERIVED FROM BUILDINGS

A building's functional performance comprises building features/elements intentionally designed for and commissioned for a specific functional performance, viz., structural performance, thermal comfort, acoustics, etc (see Fig. 7). With the ubiquitous adoption and spread of digitalization, smart features in buildings is an emerging functional performance. Further, with the advent of climate change, contamination and widespread disruption in planetary ecosystems, buildings have to take on additional functionalities of providing ecosystem services such as sequestering carbon, promoting local biodiversity, detoxing soil, water and air, restoring disrupted ecosystem services and encouraging socialization and an enriching sensory re-connection with nature. As discussed earlier, each of the building functional performances need to be re-examined for safety and



sustainability, keeping in mind life-cycle performance, particularly use and end-of-life, for example additives used to enhance structural performance/durability may eventually breakdown and contribute to microplastics, leading to soil and water contamination. Fire retardants comprise forever chemicals that get dispersed in the environment on use. LED luminaries, though significantly reduce energy consumption, contribute to impaired vision and stress.

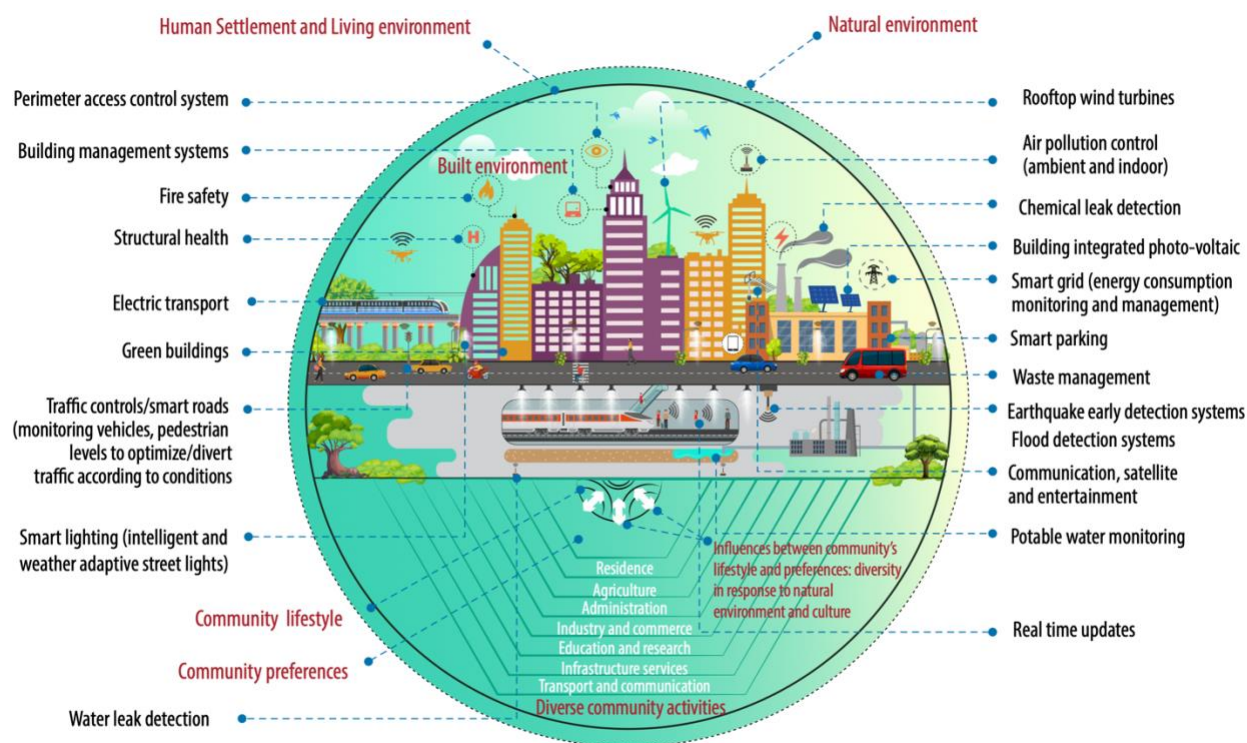

**FIG. 8 ILLUSTRATING THE MODERN LIVING ENVIRONMENT**

The characteristics and components of contemporary living spaces are comprehensively depicted in Fig. 8. Besides the environmental uptake of emissions and waste arising from the various functionalities served by the building, each of the functional performance shall account for the safety of the occupant from three modes of exposure, viz., ingestion, inhalation and dermal (skin) contact. The built environment thus has to service four interlinked and interdependent D's, viz., Decarbonisation, Democratisation, Digitalization and Detoxification. Decarbonization and Detoxification have direct implications at the planetary scale, while Democratization and Digitalization have direct implications on the occupant and building scale. All the four D's need to leverage a fifth D, viz., Diversity. The diversity prevalent in various building typologies, climatic conditions, climate-change vulnerabilities, terrain, biodiversity, population density, etc., provides ample opportunity (including innovation and economic growth) to formulate and implement locally attuned

interventions supporting planetary decarbonisation and detox for sustainability. Diversity also provides the opportunity to identify and implement nature based solutions that provide one of the strongest interventions to limit breaching 2°C global warming (see Fig. 9).

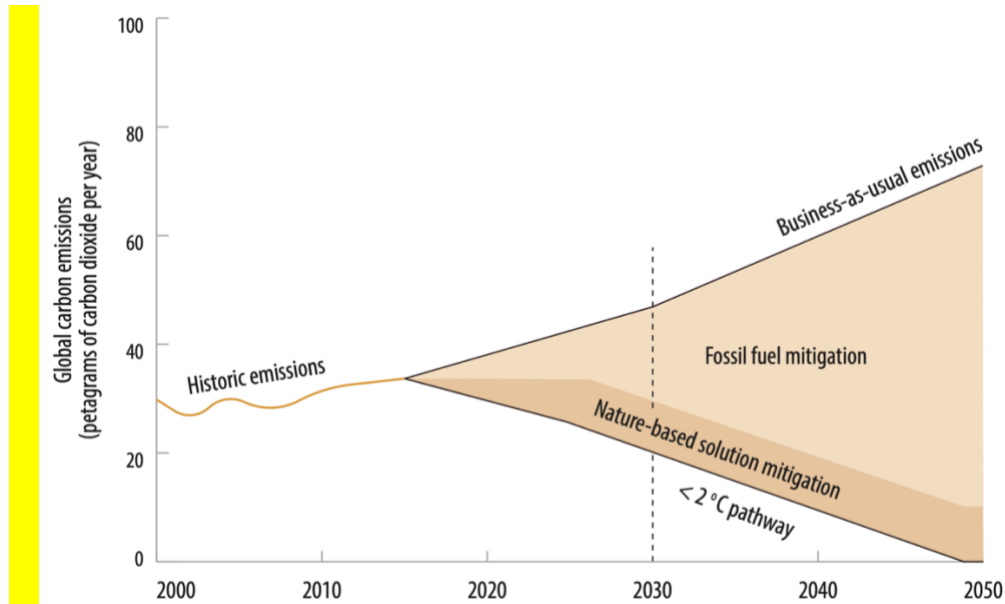

**FIG. 9 ILLUSTRATING THE ABILITY OF NATURE-BASED SOLUTIONS IN PROVIDING THE REQUIRED MITIGATION TO RESTRAIN GLOBAL WARMING**

Recommendations and opportunities for Decarbonisation, Democratisation and Digitalization, at the building, community and national/regional scale are tabulated below (see Tables 1, 2 and 3).



**TABLE 1 BUILDING LEVEL RECOMMENDATIONS AND OPPORTUNITIES**

<b>Decarbonize</b>	<b>Democratize</b>	<b>Digitalize</b>
Systems approach to life cycle assessment: R&D, tools and calculators (framework/software).	Strategic energy conservation measures-driven retrofits, and adaptive reuse of existing buildings.	Data analysis and scientific underpinnings for passive and active systems.
Biogenic, innovative vernacular, and remedial building materials and construction, that may be modularized, but customizable and scalable for climate-responsive buildings.	Technologies for monitoring and improving air quality.	Building management systems: Mechanical, electrical, lighting, computer based control system.
Investment and R&D in carbon capture, utilization and storage in buildings using alternate building materials and manufacturing with low-carbon cement and steel.	Passive methods for buildings to inherently provide environmental comfort (thermal, visual, acoustic, fresh air, daylight, ventilation).	Energy management and information systems.
Circularity of building assemblies and value chains, use of recycled/upcycled waste/end-of-life materials/products.	Innovative active energy thermal, visual, comfort and wellness technologies for health and productivity.	Systems-wide digital monitoring and controls platforms: Integrated and networked command and control centres for operations management.
Utilization of passive methods to reduce demand for active energy use, e.g. cooling, heating, and artificial lighting, plug and process loads.	Materials safety/durability R&D/ testing.	Smart, low-energy self-powered switches and sensors.
Energy-efficient technologies for	Re-introduction of innovative vernacular construction.	
a) Lighting, space and water heating & cooling, process equipment.		
b) Domestic/ commercial/ agricultural refrigeration devices.		
Minimum energy performance standards for appliances and equipment, and supply chains that provide technologies at highest performance levels .		

Review building design and monitor operations for code compliance.		
--	--	--

**TABLE 2 COMMUNITY LEVEL RECOMMENDATIONS AND OPPORTUNITIES**

Decarbonize	Democratize	Digitalize
<p>Investments in distributed renewables, thermal/electrochemical storage, building-to-grid integration technologies.</p> <p>Renewable energy forecasting, technologies, and policies for their end-of-life management.</p> <p>Market-based instruments e.g. incentives and penalties to encourage zero net energy communities.</p>	<p>Develop frameworks to facilitate design/ retrofit for adaptive, inclusive, polychronic spaces.</p> <p>Behavioural research/campaigns promoting civic sense and wellness in built environment including open spaces.</p> <p>Inclusion through accessibility to housing, barrier-free mobility, clean energy, clean water, clean air, open space and sanitation.</p> <p>Invest in fostering and monitoring occupant wellness and environmental quality in outdoor and semi-outdoor spaces and urban heat island countermeasures.</p> <p>Develop economic generation, polychronic spaces within communities e.g. MSME, startups, cottage industries, co-working.</p> <p>Upskilling to plan and deploy accessible practices and technologies.</p> <p>Invest in hierarchy of heritage - and biodiversity-integrated outdoor community space infrastructure, de- densification, plantation, and urban agriculture.</p>	<p>Large-scale investments to develop smart communities.</p> <p>Energy data infrastructure, buildings models, and controls.</p> <p>EV-to-grid load flexibility and services.</p> <p>Data from non-energy verticals, e.g. GIS, demographics, health, environment, commute data.</p> <p>Community EOPS data acquisition and software platforms to plan and operate the integrated infrastructure systems that includes.</p> <ul style="list-style-type: none"> <li>• Infrastructure digital twin</li> <li>• Smart meters on the utility side and demand side</li> <li>• Monitoring and tracking of resource state, consumption, patterns of resource use</li> <li>• Technologies for fail-safe communications</li> <li>• Shared connected energy high-performance infrastructure and tech platforms</li> <li>• Flexible load management from community level energy centres, and grid-responsiveness</li> <li>• Community level monitoring and benchmarking</li> </ul>

**TABLE 3 REGIONAL/NATIONAL LEVEL RECOMMENDATIONS AND OPPORTUNITIES**

<b>Decarbonize</b>	<b>Democratize</b>	<b>Digitalize</b>
Investment in environmental revitalization and remediation (unproductive farmlands, mines, brownfield sites, etc).	Behavioural research/campaigns for opportunities leveraging inherent local culture for resource conservation.	Technologies for AI/ML overlay for built environment data and renewable energy integration (e.g. geothermal solar hybrid).
Augment national level policies suitable for regional diversities, environmental sensitivities (climatic diversities), ecosystem services, occupations and resource availability.	Partnerships with key science collaborators/communities aligned to national scientific priorities, e.g. industry-academia-government partnerships.	Investments to develop and expand internet and communications infrastructure.
Policies to mitigate climate change: carbon credits, carbon tax, cap and trade emissions trading programs.	A digital literacy and leadership program to empower building designers, operators and sustainability managers.	Invest in development of national blockchain platforms for decentralized governance and resource accessibility.
Technologies for 100% electrification/ renewables of road transport (heavy, medium, and light-duty) railways and shipping.		Early warning and disaster management (preparedness, resilience and response) digital platforms to maintain accessibility.
		National level benchmarking for built environment metrics e.g. emissions, energy consumption from built environment sectors.
		Open-access digital repository for regionally applicable materials, performance standards, designs.

### 3.2 Adaptation of Buildings to Climate-change

Adaptation is the ability and resilience to respond to and withstand external variabilities, both prevalent and emerging, viz. temperatures, toxicity, pandemics, etc. The following fig. 10 maps adaptation related parameters for the occupant and buildings (individual and clusters) in the context of the various functional performances and natural processes (including climate change, resource availability, etc.).

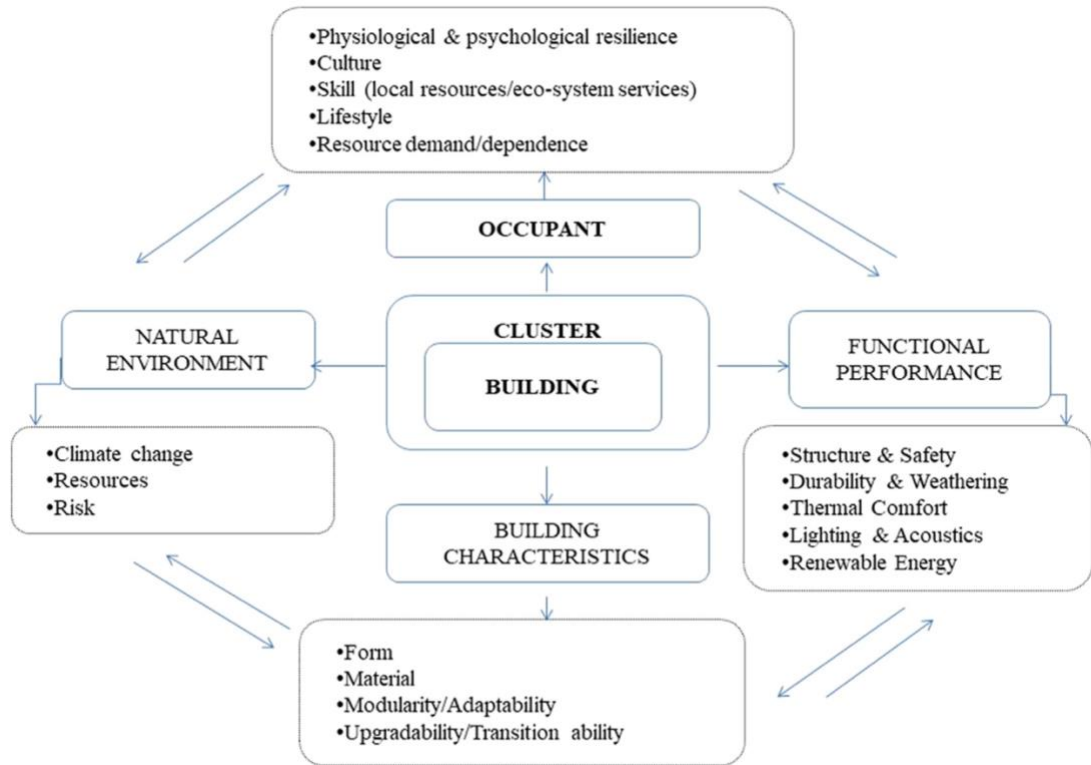

**FIG. 10 MAPPING ADAPTATION IN THE CONTEXT OF THE BUILT-ENVIRONMENT**

Given various climate-change scenarios, a recent study has identified the likelihood of a new climate zone, Extreme-hot (based on the National Building Code Classification) (see Table 4).

Sl. No.	Climatic zone	Mean monthly maximum temperature (°C)	Mean monthly relative humidity (%)
1	Extreme-Hot	above 35	below 55
2	Hot-Dry	above 30	below 55
3	Warm-Humid	above 30	above 55
4	Temperate	between 25–30	above 75
5	Cold	below 25	below 75
6	Composite	Any zone doesn't have definite season for more than six months	

**TABLE 4 ILLUSTRATING THE LIKELIHOOD OF A NEW CLIMATIC ZONE UNDER GLOBAL WARMING**

The key elements influencing the adaptive capacity of buildings are outlined in Fig. 11.

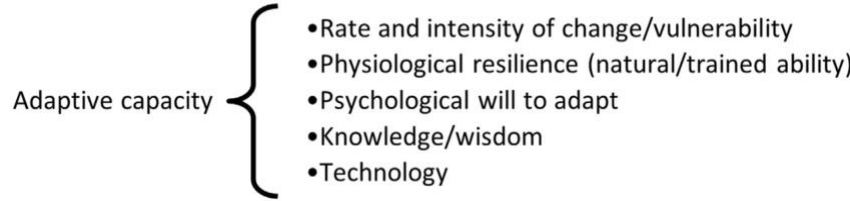

**FIG. 11 ILLUSTRATING FACTORS DETERMINING ADAPTIVE CAPACITY IN BUILDINGS**

The range of approaches to adapting to climate change is detailed in Table 5.

Adaptation mechanisms	Description	Cluster/building/occupant levels
Autonomous/reactive/spontaneous	Responding to the experienced climate and its effects, focusing on climate change	Cluster/Building/Occupant
Planned/anticipatory	Proactive measures taken to lessen the impacts, anticipating climate change	Cluster/Building/Occupant
Incremental	Preserving the integrity or process of any system	Cluster
Transformational	Changes in the basic features of a system related to climate effects	Cluster/Building
Passive	Behavioral changes	Occupant/Building
Deliberate reactive	Management actions after climate change effects	Cluster/Building
Anticipatory	Regulatory actions for climate change preparations	Cluster
Hard	Alterations in the structure of a building	Building
Soft	Behavioral strategies like control of window openings	Occupant

**TABLE 5 ILLUSTRATING VARIOUS CLIMATE-CHANGE ADAPTATION MECHANISMS**

The diverse range of climate-responsive strategies and adaptation mechanisms for addressing climate change is systematically presented in Table 6.

	Climate change impacts	Climate-responsive adaptation strategies	Type of adaptation mechanism
Occupant	Thermal discomfort	Changes in the type and fabric of clothing, including knit and fit	Autonomous/reactive/spontaneous and passive
		Adaptive use of openings, blinds, curtains, and shades	Autonomous/reactive/spontaneous and soft
		Change of location, operating windows	Autonomous/reactive/spontaneous
	Reduced productivity and performance	Behavioral thermoregulation, increase or decrease metabolic rate	Planned/anticipatory or Autonomous/reactive/spontaneous
	Mortality, illness, and injury	Behavioral thermoregulation	Passive
Buildings	Thermal discomfort, low indoor environmental quality	Implement passive design techniques	Passive or planned/anticipatory
		Region-specific designs	Passive or planned/anticipatory
		Proper shading devices	Planned/anticipatory
		Double skin façade or envelope	Planned/anticipatory
		Utilization of natural ventilation	Planned/anticipatory
		Adaptive usage of balconies/doors/windows/curtains/blinds	Passive, Autonomous/reactive/spontaneous
		Flexible interior spaces	Autonomous/reactive/spontaneous
		Proper usage of building envelope materials	Planned/anticipatory
		Changing building envelope characteristics	Hard or deliberate reactive
		Energy-saving building codes	Planned/anticipatory
		Proper insulation techniques	Planned/anticipatory or deliberate reactive or transformational
	Green roofs/terrace gardens	Planned/anticipatory or deliberate reactive or transformational	
	Flooding	Flexible ground and basement floors, buildings supported in pillars	Planned/anticipatory
Cluster of buildings	Urban heat island	Increased vegetation/Xeriscaping	Planned/anticipatory or deliberate reactive or transformational
		Usage of cool pavement materials	Anticipatory
	Drainage overflow, storage and buffering of rainwater, flooding	Open stormwater systems, rainwater harvesting, Proper design of drainage systems	Planned/anticipatory and incremental

**TABLE 6 ILLUSTRATING VARIOUS CLIMATE-RESPONSIVE STRATEGIES AND ADAPTATION MECHANISMS TO DEAL WITH CLIMATE-CHANGE**

### **3.3 Need for Sustainable Development**

Building construction, occupancy and additions/alterations including preventive and remedial maintenance are always energy and material intensive. Large amount of primary form of natural materials, water, air, energy, etc, are consumed. The energy and material resources required for a building can be categorised as embodied energy, recurring operation energy, refurbishment energy, and end of life disposal. These elements and their use are inter-dependent. There is need for integrated approach of considering them all together in general design development and construction practice. However, conventional approach towards utilizing them is independent of each other and results in very low efficiency in material and resource use.

With increasing urbanization and rapid rise in people's economic level and consumption pattern in many parts of the country, there is an increasing trend to consume more natural resources per capita. This is evident from the aspirational lifestyles and resulting changing tastes and expenditure patterns of individuals and societies. This is equally witnessed from modern construction trends and changing sky lines of cities that bear no resemblance to local climate and resource availability. This is constantly putting tremendous pressure on fragile ecosystem by over-exploitation of natural resources adversely affecting biodiversity of our planet. Realizing this fact, there are efforts for a changing approach towards nature from 'humanization of nature' to 'naturization of human' and more recently towards sustainable development. The concept is to ensure that every living being on earth have equal opportunity to utilize the natural resources for survival and mutual sustenance.

To achieve this, it is important to accept the major challenge in controlling and judiciously using natural resources to shrink ecological footprint. The way to achieve this is by holistically planning our growth needs, one of which is construction and combining them with need based economy, but at the same time without compromising on functionality and essential comforts.

The basic components of building facility, their inter-relation, tradeoffs and effect on surrounding micro-climatic conditions have to be estimated, to achieve the harmony between buildings and ecological surroundings. Ideally a building should symbiotically fit within prevalent natural cycles. It is necessary to assess the association of various factors involved, rationalizing the impact of construction on neighbourhood and/or building micro-climatic conditions to discern sustainability in the built environment.

### **3.4 Elements of Sustainability**

The generalized design process towards sustainability should creatively address the following considerations:

- a) Set the design parameters to be implemented to be equal to or higher than benchmarking standards given in this Code.
- b) Make the basic performance requirements and set standards, applicable/



- selectively adaptable to the climatic zone and geological conditions in which the construction is proposed.
- c) Have deep understanding of requirements of performance and human comfort in a building and its surroundings, considering building type and use, quality of building and plumbing services as desired, needs of persons with disabilities and of different age groups, and other parameters.
  - d) Question the need, identify their optimum levels in long term scenario, and take the design provisions to that level only.
  - e) Ensure what is sustainable today, remains that way in decades to come, and ensure the required performance levels of systems designed. If required extensive damages done could also be rectified/reversed in course of time.
  - f) Ensure that sustainability is not only in parts, but also a holistic effort and local action should contribute to sustainability.
  - g) Make efforts to maximize the use of traditional wisdom in design, wherever applicable, as it represents the knowledge about the long-term behaviour of materials and technology and their strengths as well as weaknesses.
  - h) While having an open approach, assess new materials and technologies for their long-term impact in the context of the country and its development priorities, before accepting them for use.
  - j) Take decision making processes to measurable levels wherever feasible, in order to make informed choices. Also by willing to accept limitations of decisions made.
  - k) Take the savings' benchmark targets closer to the minimum consumption standards; undertake value engineering exercises for deciding among the options.

This process emphasizes the requirement of bottom up approach which invariably considers microclimatic and cultural conditions around.

NOTE – The 'bottom up approach' concentrates more on how little is consumed; pursue deep understanding of sustainability; uses low technology innovations, materials and practices; recognizes performance to be more important than intent; and necessitates the use of common knowledge and common sense in design decisions. On the contrast, the 'top down approach' concentrates more on how much energy is saved; accepts the understanding of sustainability, may not be developed indigenously, more readily; uses high technology innovations, materials and practices; is driven by green brand and accompanying recognitions based on intent; and necessitates expert inputs and simulations.

The design process itself can play a significant role in creating built environment respecting all principles of sustainable development. This has to take into account various climatic zones (like hot-dry, warm-humid, composite, temperate and cold climates) as well as sun path movements, location (prone to tsunami, hurricane, etc), annual wind directions and geological conditions in the design of building, its orientations, wall and roof materials combinations, space layout, fenestrations and landscape. A solar passive architecture that places minimum energy demand in maintaining thermal comfort should be explored foremost.

The sustainable design process should be based on the principles of universal design as per Part 3 'Development Control Rules and General Building Requirements' of the Code,

so as to address accessibility needs of persons with disabilities and persons of different age groups.

Functional requirements of buildings have to also measure up to the required comfort levels demanded for all types of user requirements.

### **3.5 Life Cycle Sustenance**

The process flow from concept, design, construction, commissioning, operation and maintenance, and also decommissioning and disposal at the end of useful life of structure, should be planned and important steps chalked out for sustainable development. This should also take care of possible reuse/recycle of materials/ components/structure or parts thereof. Ideally close the loop (cradle to grave) with regards to resources originally used.

### **3.6 Technology Options**

The consequential building envelope to create harmonious development and productive living environment with neighbourhood and building environments poses one of the biggest challenges in selection of building materials, technologies and practices. It may be a combination of natural and manmade materials with least embodied energy and also leading to use of rapidly renewable resources. The trade-off between choice of the materials and technologies and their effect on environment has to be balanced with the aim of a closed-loop system. As a holistic approach, all efforts should be made towards,

- a) encouraging and harnessing building materials out of agricultural, industrial and bio-wastes, which have an enormous scope for regeneration.
- b) encouraging indigenous environment-friendly and acceptable cost-effective technologies and practices in identifying and pursuing sustainable developments amenable to local, cultural and resource diversity.
- c) identifying and encouraging appropriate technologies for more research and development applications.
- d) making building construction more indigenous, more adaptable to local climatic zone and executable to achieve the basic provisions for sustainable development to ensure sustained availability of building resources through regeneration and/or reuse/recycle.
- e) encouraging use of traditional materials, technologies, vernacular design and construction practices, which have stood the test of time and which may be blended with the modern technology applications.

### **3.7 Energy Efficient Design and Processes**

All efforts need to be made towards optimum and efficient use of energy sources for life sustenance. The increasing thrust on using non-fossil fuel energy for all needs have to be given priority consideration. The tapping of renewable sources of energy for lighting, heating, cooling and ventilation needs, deserve special attention. For example, an

improved day light factor will reduce the day lighting needs by means of supplementary lighting with added health benefits such as reduced eye strain (associated with constant elimination conditions). India with over 95 percent of the clear design sky available, the design has to fully utilize the associated benefits. While deciding on the energy choices, life cycle cost analysis including tangible and intangible benefits should be made and not look at the onetime initial capital expenditure alone. The end of life options should also be perceived.

### **3.8 Reduced Embodied and Operational Energy**

All designs, materials and technologies, construction practices should be selected and employed, aimed at reducing the overall embodied and operational energy involved in construction and operation of the built facility. The construction should promote sustainability through adoption of local resources (natural and man-made) and skills.

### **3.9 Integrated Water Management**

Considering an ever increasing demand for water for a growing population, efforts are needed to substantially reduce per capita water consumption in buildings. Integrated and sustainable water management focusing on least anthropogenic water discharge from human activities should be pursued. The use of water conserving fixtures, landscaping, rainwater harvesting, aquifer recharging and wastewater recycling need to be given due priority consideration.

### **3.10 Operation and Maintenance of Services**

This should involve use of efficient building and plumbing services components and fixtures tailor-made to meet sustainability objectives and creating sufficient awareness among the users of building facility and its services, during the occupancy stage.

### **3.11 Monitoring Compliances**

The measures adopted during design, construction and occupancy stages should be monitored against norms as per this Code at periodic time interval to ensure sustainability.

### **3.12 Corporate Governance**

The concerned top management should ensure association of all stakeholders including the training and awareness in pursuing and achieving needs for sustainable development at all stages of building lifecycle (from design to end of life). The environmental impact assessment should be carried out and remedial measures based on the findings should be taken during the life cycle of the buildings.

### **3.13 Disaster Preparedness**

#### **3.13.1 General**

Disaster preparedness as a part of approach to sustainability is in addition to the normal considerations of structural safety, health safety, fire safety and public safety taken into account in the building planning, design, construction, use and occupancy, and end of life. The disasters may be natural disasters such as earthquake, floods, cyclone, tsunami, landslides and avalanches; and man-made disasters such as nuclear, chemical, and biological disasters, explosions, act of sabotage and terrorism. Consequence of such disasters could be life threatening and debilitating in the long run.

Also man-made or natural disasters can trigger combined form of progressive disasters. The severity index is another important factor which will be governed by geomorphology, wind flows and cyclonic vulnerability, and climatic zone wherein the construction is proposed. See Part 6 'Structural Design' of the Code for structural design of buildings for various loads, forces and effects using various building material options and structure systems.

### **3.13.2 Approach**

The approach to disaster mitigation and management should be holistic and integrated with emphasis on prevention, mitigation and preparedness rather than being relief centric. The approach should emphasize on preparedness through planning, protection, training and partnership measures with associated stakeholders.

These efforts are aimed to protect and conserve existing development and also to minimize losses to lives, livelihood and property with clear cut focus on protection of environment. The approach shall be towards integrating disaster management as a part of design development, construction practices and management, operation and maintenance and end of life strategies. The required awareness should be achieved through multi stakeholder based planning, awareness, displays, mock drills and adequate training to both aged and young.

The disaster mitigation should also comprise identification of risks during construction, risks during occupancy stages/operations and preparing disaster preparedness plan by decommissioning. The occupancy type, density of occupancy and any specific/strategic aspects should be considered while working out disaster preparedness plan to achieve minimum damages and/or losses to lives, livelihood, properties and environment for the sustainable buildings for least damages or losses.

### **3.13.3 Disaster Risk Assessment and Mitigation**

The formulation of disaster preparedness plan for any location should comprise the following steps:

- a) *Step 1* – Identify the geomorphology; river, coastal and cyclonic proximity; and climatic zone related disasters risks.

- b) *Step 2* – Identify population, business related disasters and vulnerabilities.
- c) *Step 3* – Carry out risk assessment through hazard analysis and vulnerability analysis including possible combining effects of multiple hazards. Also include the effect on micro-climate and environment biodiversity. Coastal zones which are falling in high cyclonic flood zone, tsunami, and seismic zones of high intensity and landslide sensitive areas should receive special attention.
- d) *Step 4* – Identify the socio-economic, socio-political hazards and vulnerabilities attributed to man-made disasters.
- e) *Step 5* – Prepare a disaster risk mitigation plan supported with sufficient budgetary provisions.
- f) *Step 6* – The disaster resistant building construction and infrastructure development features shall form part of the submittal to the Authority for statutory approvals.
- g) *Step 7* – Establish/nominate a responsible senior person/safety officer as controller for regulating, planning and monitoring disaster preparedness plan for whole project. Carry out all constructions, installations and operations in line with the disaster resistant features for each of the vulnerabilities.
- h) *Step 8* – Prepare and have mock drills at regular intervals for creating awareness and response preparation amongst stakeholder involved.
- j) *Step 9* – Prepare operation manual for post-construction operation and up keep of disaster resistant features and equipment.

The basic action plan should focus on capacity building amongst stakeholders involved, communication, co-ordination, role of information technology, role of every individual working at site and role of emergency response cell of building in conjunction with the mitigation plans of local/state level authorities. The possible after-effects on human and natural habitats and mitigation plan should form integral part of disaster preparedness plan for least damage to human life, built environment and related ecosystems.

#### **4 APPLICABILITY OF THIS PART**

**4.1** Where a building is erected, this Part of the Code shall be applicable to such building.

In case of renovation or addition and/or alteration to an existing building, this Part of the Code shall apply to such parts of the building. However, owner shall have opportunity to get an existing building or part thereof evaluated under the provisions of this Part of the Code.

**4.2** This Part of the Code may also be applied to the development projects.

## **5 IMPLEMENTATION OF THIS PART**

**5.1** Provisions for building planning, design including material selection and structural design, construction, operation and maintenance have been covered in National Building Code of India: Part 0 to Part 10. These also allow various options to be exercised, for example while various building materials have been listed therein along with their quality requirements for compliance, the choice may rest with the owner/ building professionals, say for walling or masonry units, the options could be: use of common burnt clay bricks, perforated clay bricks, hollow clay bricks, fly ash lime bricks, fly ash clay bricks, calcium silicate bricks, solid/hollow concrete blocks, light weight concrete blocks, autoclaved aerated concrete blocks, preformed foam concrete blocks or any other alternative specified. This Part of the Code discusses such options from sustainability point of view for guiding in their appropriate selection. Similar explanation applies to other materials as also other aspects in planning, design, construction, operation and maintenance. However, once a choice of material, design methodology, construction technique/methodology, operation and maintenance related options, etc, is made, the provisions given in this Part of the Code for the same shall be complied with. This Part also prescribes provisions to be necessarily complied with so as to help achieve the objective of sustainability.

This Part should, therefore, be implemented in light of the above while following the approach given in **3**. The Authority may require submission and verification of relevant documents while applying for building permit, to demonstrate compliance to the requirements of various provisions under this Part.

## **6 SITING, FORM AND DESIGN**

### **6.1 General**

Before initiating the formal design process, it is critical to evaluate all the passive design options to take advantage of local site and climatic conditions, acceptable thermal comfort conditions and other occupant requirements. Passive techniques are very cost effective, climate responsive and energy efficient and help a building integrate better with its immediate environment and most importantly do not create any negative impact on the environment unlike active systems that may cause various negative impacts including ozone depletion, global warming and environmental disruptions. The objective, therefore, is to encourage passive design strategies for every building as a means to reducing overall energy demand before pursuing active and mechanical means in an effort to not only save energy but also to minimize the overall negative impact on the environment.

The requirements for the development of buildings and building sites that encourages sustainable building practices including siting, form and architectural approach towards sustainable development, are given in **6.2**. The purpose includes providing guidelines that establish objectives for siting and form of residential, mercantile, industrial or other building occupancy developments early in the design stage so as to address sustainability

through design. These objectives include, but are not limited to, energy conservation, water conservation and reduced greenhouse gas emissions.

## **6.2 Site Design and Development**

### **6.2.1 *Site Assessment Prior to Design***

The responsible design professional shall prepare an assessment of the onsite natural resources and pre-site conditions. The person shall,

- a) establish, if there are any protected areas such as floodplains; forest department areas; water bodies such as sea, lakes, rivers, wetlands, tributaries and/or streams; coastal regulation protected areas; defence areas; public parks and recreation areas (unless otherwise used for the purpose of the park); natural contours / terrain requiring protection and agricultural land (unless serving an agriculturally related purpose such as storage, processing, transport, etc) and demonstrate that no critical natural resource is impacted by the project and/or dredging operations;
- b) establish the degree to which the existing soil at site and hydrology has been disturbed prior to development and demonstrate various site erosion protection measures taken including measures to preserve natural stormwater drainage system, top soil and existing vegetation, minimize soil disturbance as specified in Part 10 'Landscape Development, Signs and Outdoor Display Structures Section 1 Landscape Planning, Design and Development' of the code;
- c) identify and ensure diversion, avoidance of existing water, power, communication, sewerage lines, saving/replanting of old trees, removal of existing invasive vegetation on site and that no invasive vegetation is planted post completion; and
- d) identify and ascertain the natural resources available onsite and surrounding areas and ensure optimum utilization of the same in construction and post occupancy.

A site assessment report for the building/development project shall be prepared.

### **6.2.2 *Building Form, Orientation and Shading***

The development shall plan on locating, orienting and shading the building so that,

- a) there is adequate provision for external shading of the facades during the peak summer season;
- b) there is adequate provision for vertical shading to prevent direct solar radiation and glare due to low altitude sun angles, specifically on the eastern and western facades;
- c) the building is oriented optimally based on sun-path and engineering analysis; and

- d) there is adequate protection for the building envelope against thermal losses, drafts and degradation by natural elements such as wind, dust, sand, snow, rainwater, hail, etc.

The above strategies shall be implemented based on the climatic conditions of the location. Specifically, the designs should be based on the heating degree days and cooling degree days of the actual location of the building. In the absence of this data, a more generalist approach based on the five climatic zones of the country may be used.

The responsible design professional shall carry out building orientation and shading studies and establish the optimal building orientation for the project and ensure appropriate shading design such that the facades are shaded for more than 50 percent of the summer solstice. A solar path analysis shall be done as an aid in arriving at optimum form and orientation for the building. Appropriate shading design can be arrived at either through simulation approach or by using the prescriptive shading norms as indicated in the SP 41:1987 'Handbook on the Functional Requirements of Buildings (other than industrial buildings)'. A design report showing both the optimum orientation and shading design strategies along with justification for the selection of the same shall be prepared.

### **6.2.3** *Thermal Massing*

The responsible design professional shall carry out building thermal massing studies to evaluate the impact on thermal mass on the consequent thermal transmittance and energy performance of the building based on the sun-path analysis and local/equivalent weather data. A report showing both the optimal thermal massing and the choice and justification of the proposed wall material of the building together with the design approach for decision making shall be prepared, together with other documents while applying for the building permit.

### **6.2.4** *Reduced Building Footprint in Multi-storeyed Building Designs*

The requirements for open spaces (within a plot) as specified in **8** of Part 3 'Development Control Rules and General Building Requirements' of the Code shall be complied with. In any case, at least 30 percent of the open spaces shall be maintained as softscapes (permeable surface on ground). For areas where the calculated softscape area requirement is less than 10 percent of the total plot area, a minimum of 10 percent softscape area shall be provided.

### **6.2.5** *Optimum Building Volume*

For air conditioned buildings, efforts shall be made in design to reduce building volume by reducing floor to floor and floor to ceiling height without compromising the utility and functional efficiency of the building. For natural ventilated buildings or mixed mode ventilated building, the optimum building volume and floor to floor heights to be ascertained and a report on the design and justification of the same shall be prepared.



### **6.2.6 *Building Form Development Plan***

A report shall be prepared on the evolution of the form of the building based on science of architecture, climatology and building physics. The plan shall be in line with the decision making process of the project team and a narrative shall be prepared briefly mentioning the justification behind the selected building form and orientation of the building and shading devices to ensure that the final design meets with the intent of this Part.

### **6.2.7 *Natural Ventilation, Cooling and Wind Effects***

A report illustrating the evaluation of the various natural ventilation and cooling studies to maximize natural ventilation or mixed mode ventilation based on adaptive thermal comfort criteria for the project, shall be prepared. In addition, for high rise buildings, wind analysis shall be carried out to evaluate the impact of wind movement and natural air flow changes because of the new building proposed to be erected. Strategies may include application of cross-ventilation and thermal comfort, factoring prevalent wind patterns, seasonality, stack effect and other principles. A narrative on how these aspects have been factored in the design shall be prepared.

### **6.2.8 *Optimal Daylighting***

A day lighting analysis study based on the proposed form of the building for the project shall be carried out and a report thereof prepared. It shall be demonstrated that at least 25 percent of the regularly occupied areas of the building achieve sufficient day lighting with a minimum day lighting factor of 2 percent or as described in SP 41:1987 'Handbook on the functional requirements of buildings (other than industrial building)'. For details of day lighting harvesting methods and calculations (see **8.1.3.2**).

### **6.2.9 *Defining Building Service Life in Terms of Minimum Component Service Life***

A building service life plan shall be prepared along with the design and construction documents. The plan shall clearly indicate the design service life and the minimum design service life shall be not less than 60 years for the structure itself and not less than 10 years for various service components, equipment and systems within the building. All plan shall include dismantling, de-mounting and re-use plan.

### **6.2.10 *Life Cycle Assessment (Optional)***

The materials and assemblies may be selected based on their carbon footprint (GHG emission potentials) and/or a life cycle assessment of the embodied energy of the product. For more details on LCA analysis of building materials (see **9.1.4**).

## **7 EXTERNAL DEVELOPMENT AND LANDSCAPE**

### **7.1 Landscape Planning and Design**

The landscape planning and design shall be in accordance with Part 10 'Landscape Development, Signs and Outdoor Display Structures, Section 1 Landscape Planning, Design and Development' of the Code. In addition, the provisions given in **7.1.1** to **7.1.3** shall be followed.

### **7.1.1** *Landscape Design*

Proper landscaping helps in maintaining natural capacity of site for stormwater management, filtration, groundwater recharge and maintenance of soil structure thereby contributing to soil organic matter, and preventing erosion. It helps in moderating microclimate through evaporation, transpiration and the uptake and storage of carbon in trees and other vegetation.

#### **7.1.1.1** *Microclimatic conditions*

Microclimatic conditions play an important role in landscape design and in working out irrigation requirements, as it accounts for the environmental conditions specific to the landscape, including temperature, wind and humidity. For example, a water body can increase the humidity and a wind funnel can increase the evapotranspiration rate and hence the irrigation requirement. The microclimatic conditions may be taken into account in landscape irrigation calculations by applying a microclimate factor.

The average microclimate factor is 1.0 and this refers to conditions where the landscape evapotranspiration rate is unaffected by buildings, pavements, reflective surfaces and slopes. Higher microclimate factor conditions occur where evaporative potential is increased due to landscapes surrounded by heat absorbing and reflective surfaces or due to exposure to particularly windy conditions. Examples of high microclimate factor areas include parking lots, west sides of buildings, west and south sides of slopes, medians, and areas experiencing wind funnel effects. Areas with low microclimate factor include shaded areas and areas protected from wind. North sides of buildings, courtyards, areas under wide building overhangs and north sides of slopes.

#### **7.1.1.2** *External noise reduction/mitigation practices*

Need for reducing the noise at site shall be assessed. If so required, appropriate measures may be taken for noise abatement, such as quieter pavement or road surfacing, dense foliage, earth berms, barriers or screens, and scheduling maintenance activities when site users are not present. Walls, fences and vegetation may also be used to break, guide, deflect or filter the wind and thereby alter its effects. Noise may be reduced with use broad-leaved trees more than with the conifers and this further improves when foliage extends close to the ground. The best location for a noise barrier is either very close to the source or very close to the receiver while the worst position for attenuation is halfway between them. Provisions of Part 8 'Building Services, Section 4 Acoustics, Sound Insulation and Noise Control' of the Code shall be followed.

### **7.1.1.3 *Building shadow considerations on landscape***

Vegetation provides climate moderating benefits as well as benefits to human health. Most vegetation requires sunlight in varying degrees for their growth and maintenance. The buildings by their design, shade certain parts of the external areas for some part of the day or other. External landscapes shall be designed taking the shading pattern of the buildings into consideration. For instance the northern side external areas of the building tend to be shaded for large parts of the day, while the southern side has access to sunlight for most times of the day, the choice of vegetation should be based on the availability of sunlight along different solar exposures and the requirement of various species of vegetation. Vegetation also has the potential to reduce the energy consumption of a building by providing shading and a cool microclimate. Vegetation and/or vegetated structures shall be kept in strategic locations around buildings to reduce energy consumption and costs associated with indoor climate control.

## **7.1.2 *Hard Landscape Design***

### **7.1.2.1 *Pervious paving design***

Pervious paving helps in holding rainwater, reducing the rate of storm water flow, infiltrating storm water into the ground for reuse and also helps in filtering the rainwater. Besides helping in storm water management, pervious paving helps in reducing the heat island effect. For sustainable site planning, perviousness in the paved areas of the site may be maximized.

However, the rainwater harvesting potential of pervious paving is subject to local geomorphological formations and the use of the same should be assessed based on local conditions. For example, in coastal areas, where the water table may be high and the water absorptive capacity is low, pervious paving may not be as effective.

### **7.1.2.2 *Heat island effect and parking design***

The heat island effect raises the localized temperature, impacting local climate/microclimate. Plants and animals that are sensitive to large fluctuations in day time and night time temperatures may not thrive in areas affected by heat island. Heat islands also exacerbate air pollution as smog is produced faster at higher temperatures and as rising temperatures lead to increased cooling requirements, requiring energy and causing associated emissions.

Open parking areas consisting of concrete and asphalt absorb heat and contribute substantially to the heat island effect. Shading and/or use of light-coloured/high-albedo materials and/or open grid pavement for the site's non-roof impervious surfaces, including parking lots, walkways, plazas, etc, shall be made to help in reducing the heat island effect.

The solar energy should instead be utilized for generation of renewable energy, thus

-serving the dual purpose of dampening the heat island effect and reduction in use of fossil fuel for energy generation (see **11.16**).

### **7.1.2.3** *Post-occupancy maintenance*

A site maintenance plan shall be developed that outlines the long term strategies and identifies short-term actions to achieve sustainable maintenance goals. The plan should address issues such as plant maintenance, integrated pest management, soil management, fertilizer use, rainwater harvesting, reducing freshwater consumption, site safety, and irrigation allotment and schedule.

### **7.1.3** *Soft Landscape Design*

#### **7.1.3.1** *Preserving top soil*

Healthy soils allow rainwater to penetrate, preventing excess runoff, sedimentation, erosion, and flooding. Soils also help clean and store water, and recharge groundwater. By storing water and slowing the delivery of water to plants, healthy soils play a significant role in vegetation health. In areas of previously disturbed soils, soil function shall be restored to rebuild ability of soils to support healthy plants, biological communities, and water storage and infiltration. In existing soils, depending upon the requirement, the need of soil compaction, organic matter levels, and the balance of soil organisms shall be addressed. It shall be ensured that adequate soil volume is made available for proper plant growth. In order to protect soil horizons and maintain soil structure, existing hydrology, organic matter, and nutrients stored in soils, the disturbance to healthy soil shall be limited. Typically, the first 200 mm soil depth is most conducive for plant growth, and is considered as top soil. Where healthy top soil is being disturbed due to construction activities like excavation, the top soil should be stripped and stacked on one side till further use. Use of excessive chemicals such as fertilizers may result in lasting damage to the soil ecology and shall, therefore, be avoided. See Part 10 'Landscape Development, Signs and Outdoor Display Structures, Section 1 Landscape Planning, Design and Development' of the Code, for further details regarding protection of landscape during construction.

#### **7.1.3.2** *Ecological design/conserving biodiversity*

A diverse range of species, especially native plants can provide habitat for native fauna, including important pollinator species (for example, insects, birds and bats) that are necessary for plant reproduction, including cultivation of crops. Also, biodiversity in landscapes helps in retaining soil nutrients and is more resistant to attacks by pests. The following considerations shall be used:

- a) *Protection and use of existing vegetation* – Such sites shall be selected that do not include habitat for threatened or endangered species. Site may be designed to minimize disruption to existing habitats. Trees designated as important by concerned local, state or central authorities shall be preserved. Mature trees are

significant community resources because of their cultural, aesthetic, or historic relevance and shall be preserved. Transplantation for mature trees within the site or to another site shall be explored, where vegetation clearing is necessary for construction.

- b) *Use of vegetation that promotes a regional identity and a sense of place* – Native plants which are endemic to the location and appropriate non-native plants adapted to site conditions, climate, and design which support biodiversity, reduced pesticide use and water conservation, shall be used. Only non-invasive plants that are nursery grown, legally harvested or salvaged for reuse from on or off-site shall be used.
- c) *Conservation of native endangered species* – Native vegetation that is endangered in the locality may be planted to conserve/enhance the gene pool of native vegetation and promote biodiversity.

#### **7.1.3.3** *Landscape design for controlling solar gain*

Vegetation placed in strategic locations around buildings provides an opportunity to reduce energy consumption and costs associated with indoor climate control for cooling. Trees, shaded trellises, green roofs, green facades and green walls may be used individually or in conjunction with other measures to increase shading both on the ground and on the building surface. Deciduous trees allow access to the sun in winter and provide shade in summer. Vegetation provides significant opportunities in conserving building energy consumption, especially if the west, south-west, south-east and east facades of the building are shaded. For buildings with natural ventilation, the vegetation species shall be carefully chosen such that they provide shade, but do not significantly block cool breezes or any convective air currents.

#### **7.1.3.4** *Vertical landscaping and roof gardens*

Roof garden and/or green walls or vertical landscaping may be provided as it helps in conserving energy by providing shading, reduces heat island effect, helps (specially in dense areas) in maintaining a certain biomass critical for human health and also helps in reducing storm water flow rates through bio-retention. Required caution shall be observed in respect of water proofing requirement for the above.

#### **7.1.3.5** *Urban agricultural practices/social forestry*

Growth of cities puts a significant pressure on natural resources resulting in drastic reduction of green open spaces, depletion of trees, heat island effects, and floods and other natural disasters, further aggravated by the effects of climate change. Proper attention may be given to the potentials of urban forestry and agriculture for contributing towards urban greening, heat reduction, storage of excess storm water and maintaining flood plains free from construction. Large scale developments that exceed 10 hectares should be encouraged to fulfil minimum 5 percent bio-capacity required to sustain

themselves.

## 7.2 Rainwater Harvesting – Surface Runoff

### 7.2.1 Rainwater Harvesting

Rainwater harvesting refers to collection and storage of rainwater and also other activities aimed at harvesting surface and groundwater, prevention of losses through evaporation and seepage and all other hydrological studies and engineering interventions, aimed at conservation and efficient utilization of the limited water endowment of physiographic unit such as watershed. In general, rainwater harvesting is the activity of direct collection of rainwater. The rainwater collected can be stored for direct use or can be recharged into the groundwater. While enough measures should be taken voluntarily, the Authority should encourage and appropriately provide for ensuring rainwater harvesting in outdoor built environment.

The system of collection of rainwater and its conservation for future needs has traditionally been practiced in the country, such as through *Baoris*, step wells, lakes, tanks, roof top collection systems, etc, to meet the domestic and irrigation demands. This also helps to arrest groundwater decline and augment groundwater table, beneficiate water quality in aquifers, conserve surface water runoff during monsoon, reduce soil erosion and inculcate a culture of water conservation.

Two broad approaches to rainwater harvesting are:

- a) *Storing rainwater for direct use* – Under this approach, for domestic and irrigation purposes, the rainwater is directly collected either in the natural or man-made structures such as *Nadi*, *Tanka*, *Kund*, sand filter bed, pond, rooftop rainwater collection structure, etc.

Roof rainwater collection system augments the water demands by collecting rainwater from the roof and diverting it to specially designed storage or recharge tanks, as per the requirement. On sloping roofs, evaporation losses are small, so collection efficiency may be of the order of 85 percent. Rainwater may be collected from any kind of roof. Tiled or metal roofs are easier to use for the purpose and a smooth surface for the roof will help in water flow and collection.

To reduce contamination of rooftop rainwater, the necessary actions and precautions as given below shall be followed:

- 1) Avoid overhanging of trees above the roof to prevent leaves and bird droppings falling on the roof.
- 2) Do not allow the first rainfall to enter the tank by diverting it away from tank; although human or animal coliforms are not involved, bird droppings or lizard faeces, and other air borne dirt are also to be washed away from the roof.

- 3) Filter the water on entering the tank by suitable filter and also cleaning the filter and tank regularly.
  - 4) Seal tanks to keep out sunlight (to prevent algae growth), mosquitoes, lizards, birds, etc.
  - 5) Disinfect tanks once in a year with bleaching powder.
- b) *Recharging groundwater aquifers* – This approach involves use of various kinds of recharge structures, which not only arrest the water but also promote water percolation through soil strata to recharge the depleting aquifers. Structures like percolation tank, anicut, gabion, etc, facilitate the recharge of underground aquifers. However, meteorological and hydrological investigations along with geo-technical investigations shall be carried out before selecting the best suited method for groundwater recharge. Direct injection of rainwater through deep bore wells should be avoided for quality control reasons.

For rainwater harvesting a reference to **4.5.12** of Part 9 'Plumbing Services, Section 2 Drainage and Sanitation' of the Code may be made. For further details, reference may also made to good practice [11(1)].

### **7.3 Water Elements and Irrigation Practices**

#### **7.3.1 Design and Post Occupancy Maintenance of Water Features**

The site maintenance plan (see **7.1.2.3**) shall include appropriate maintenance activities for the water features taking care of the following considerations:

- a) Use of chemicals likely to harm aquatic life, such as chlorine and bromine shall be avoided.
- b) Maintenance activities to ensure that the water features do not create habitat for mosquitoes, shall be included.
- c) Water features shall be designed such that they match or mimic water in the natural environment; and water features that are incompatible with the local ecological context (*for example*, a lake in a desert) shall be avoided.
- d) Volumes of rainwater or water from other non-potable sources available on site for use in water features shall be estimated, and water features shall be so designed that these are integrated with the site so as to utilize this water on site, and not require additional water from potable water sources.
- e) Non-potable water from sources such as gray water, reclaimed water or storm-water basins shall be collected and used for non-potable applications.
- f) Design and maintain water features as natural ecosystems with water source(s), plants and aquatic organisms appropriate for local conditions.
- g) Water quality may be enhanced in created water features with biologically-based water treatment including with the use of certain enzymes, mineral, and oxygen-based additives, especially during initial establishment.
- h) Natural swimming pools or other water features intended for human contact may require additional treatment methods such as ozonation or thermal treatment.

### **7.3.2 Water Conservation and Irrigation Practices**

Selecting efficient irrigation systems, planting vegetation appropriate for site conditions and climate, and using captured rainwater or gray-water can reduce water waste and conserve sources of potable water. Typically, half of irrigation water may get wasted as a result of evaporation, wind, improper system design, and over-watering requiring the following considerations which may be followed:

- a) Low water demand vegetation (xeriscape) and high-efficiency equipment (for example, drip irrigation) and/or climate based controllers for irrigation systems should be used.
- b) If turf grasses are to be used, they should be selected, to be regionally appropriate and to minimize post-establishment requirements for irrigation. The turf area should not exceed 30 percent of the total landscaped area.
- c) Reuse gray-water, captured rainwater and/or condensate water for irrigation to decrease potable water use for irrigation as well as to create a net benefit to the local watershed by making the landscape part of the natural water-treatment process.
- d) If gray-water or wastewater is to be recycled for landscape irrigation, tests should be conducted to determine suitability for reuse.
- e) Irrigation systems should be so designed that trees, shrubs and ground cover are irrigated in separate hydrazones such that watering can be discontinued zone by zone as plants become established.
- f) A sub-surface drainage system shall be planned in areas covered with turf to collect excess water for reuse.

## **7.4 External Access Design**

### **7.4.1 Reduced Environmental Impacts from Parking Facilities**

Open parking areas, if largely made of concrete and asphalt, absorb heat and contribute substantially to the heat island effect. This shall be mitigated by following the considerations given below:

- a) Rendering these areas white or light in colour instead of black, so that they may reflect a lot of sunlight back to space rather than absorbing it.
- b) Providing shade and/or using light-coloured/high-albedo materials and/or open grid pavement for the site's non-roof impervious surfaces, including parking lots, walkways, plazas, etc.
- c) Limiting the net paved area of the site under parking, roads, paths, or any other use so as not to exceed 25 percent of the site area or net imperviousness of the site not to exceed the imperviousness factor as prescribed in **4.5.11.2.1** of Part 9 'Plumbing Services, Section 2 Drainage and Sanitation' of the Code, whichever is more stringent.



Additionally, the following shall be complied with:

- 1) More than 50 percent of the total paved area shall have pervious paving/open grid pavement/grass pavers, or
- 2) A minimum 50 percent of the total paved area (including parking) shall have shading by vegetated roof/pergola with planters, or
- 3) A minimum 50 percent of the total impervious paving area (including parking) shall be topped with finish having solar reflectance of 0.5 or higher.

The external access, including pedestrian walkways/paths shall be designed and developed in accordance with Part 3 'Development Control Rules and General Building Requirements' of the Code.

#### **7.4.2 Long term Public and Private Transportation Plan**

The long term public and private transportation plan shall take care of the following considerations:

- a) Incorporating urban transportation as an important parameter at the urban planning stage rather than being a consequential requirement;
- b) Encouraging integrated land use and transport planning in cities so that travel distances are minimized and access to livelihoods, education, and other social needs, especially for the marginal segments of the urban population is improved;
- c) Improving access of business to markets and the various factors of production;
- d) Bringing about a more equitable allocation of road space with people, rather than vehicles, as its main focus;
- e) Encouraging greater use of public transport and non-motorized modes;
- f) Enabling the establishment of quality focussed multi-modal public transport systems that are well integrated, providing seamless travel across modes;
- g) Establishing enforcement mechanisms to ensure efficiency and enhanced safety for the transport system users;
- h) Establishing institutional mechanisms for enhanced coordination in the planning and management of transport systems;
- j) Introducing intelligent transport systems for traffic management;
- k) Addressing concerns of road safety and trauma response;
- m) Reducing pollution levels through appropriate travelling practices, better enforcement, stricter norms, technological improvements, use of electrically operated vehicles etc; and
- n) Building capacity (institutional and manpower) to plan for sustainable urban transport and establishing knowledge management system.

#### **7.4.3 Bicycle Lanes and Pedestrian Access – Safety and Comfort**

Construction of cycle tracks and pedestrian paths in cities enhances safety and thereby enhances use of non-motorized modes. The safety concern of cyclists and pedestrians should be addressed by encouraging the construction of segregated rights of way for

bicycles and pedestrians. Apart from improving safety, the segregation of vehicles moving at different speeds helps improve traffic flow, increase the average speed of traffic and reduce emissions resulting from sub-optimal speeds. Such segregated paths are useful not only along arterials, to enable full trips using non motorist transport but also as a means of improving access to major public transport stations. Such access paths, coupled with safe bicycle parking places, may be provided for promoting an increased use of public transport. Creative facilities like shade giving landscaping, provision of drinking water and resting stations along bicycle corridors should also be encouraged to help mitigate, the effect due to adverse weather conditions. The use of the central verge along many roads, along with innovatively designed road crossings, may be considered for developing as cycle tracks. At busy intersections and high traffic corridors, pedestrian crossing shall be constructed.

Following are some of the features which should be considered while designing pedestrian and cycle/cycle-rickshaw friendly environment:

- a) Design and construction ensuring safety and comfort of all the users.
- b) Use of following climatic design features for streets and public spaces to make them comfortable for pedestrians, cyclists and public transport users, based on local climate:
  - 1) Planting of deciduous trees all along the pedestrian/cycling path to provide adequate shade in summer and allow solar access in winter.
  - 2) Considerations to overhangs, arcades and closely built buildings providing shading and comfort in summer to the public realm.
  - 3) Orientation of streets to allow the desirable directional wind flow through streets and public spaces in summer and block undesirable winds in winter, to ensure comfort in the public use areas.
- c) Signalization of junctions and mid-block crossings on roads to allow safe crossings at grade.
- d) Multimodal interchange and provision of good para-transport options and walkability at the neighbourhood level as the most important factor in reducing use of private modes and also reducing transportation demand; and the following to be provided so that people can walk or cycle easily for short trips as well as for accessing mass transport stations:
  - 1) Fast and convenient interchange between modes (distances between modal changes to be as per multimodal integration and connectivity requirements).
  - 2) Closest convenient interchange access at stations for pedestrians, non-motorized modes and public/paratransport modes, preferably within 30 m to 50 m of station exits.
- e) Proper street grid density as a critical requirement in urban design to ensure small blocks and an interconnected street network to provide a walkable, public transport friendly neighbourhood as per the following:
  - 1) Street grid density of 7-10 km centre-to-centre/km<sup>2</sup> for residential-mixed use neighbourhoods and 13-20 km centre-to-centre/km<sup>2</sup> for commercial-mixed

use neighbourhoods to provide adequate connectivity and frequent directional changes for pedestrians.

- 2) Direct and shortest route/access to station through provision of cut-throughs for pedestrians and non-motorized transport through blocks above 200 m in length with a view to making smaller block sizes.
  - 3) Signalization of junctions and mid-block crossings on roads to allow safe crossings at grade at a maximum frequency of 200 m.
- f) Provisions of dedicated lanes and signal prioritization for pedestrians, non-motorized transport and public transport on major corridors so as to provide priority and congestion-free movement for these modes.
  - g) Adequate street lighting for pedestrians and bicycles to ensure their safety; minimum illuminance being 30 lux for non-shopping areas and 20 lux for shopping areas, bus stops and signalized crossings.
  - h) Commercial/hawking zones at regular intervals in accordance with the local byelaws/masterplan (within 5 min walk from every home in the city) to encourage walkability and increased street activity and to provide safety.
  - j) Amenities for public transport users:
    - 1) Amenities at-grade crosswalks (and overpasses on highways) at intervals of 80-200 m, aligning with location of transit stops, type of street/land use activities and neighbouring building entries and destinations.
    - 2) Dustbins, letter-boxes, signages and other public amenities at street corners for high usability.
    - 3) Accessible public toilets at every 500 m to 800 m distance, preferably located close to bus stops for easy access by pedestrians and public transport users.
  - k) Barrier free environment to make public streets and crosswalks fully navigable by all persons including the persons with disability and the elderly.
  - m) Vertical mixing of uses such that all non-work trips are reduced to be under 500 m walking distance such that vehicular trips may be eliminated for daily errands; for example through mixed convenient/ community shopping uses with residential uses to reduce dependency on private vehicle and shifting all short trips from private vehicle to walking, cycle-rickshaw or public transport.

#### **7.4.4 Off Street Parking**

The off street parking shall be planned taking care of the following objectives as per Part 3 'Development Control Rules and General Building Requirements' of the Code:

- a) To relieve congestion on streets by providing convenient off-street parking and loading facilities in proportion to the demand created by the use;
- b) To provide for the safe and orderly movement of traffic through proper design and location of adequate parking, loading, and manoeuvring areas;
- c) To protect neighbourhoods and surrounding land uses from vehicular parking, loading and traffic congestion, noise and dust, through proper aesthetic design and

location of entries, parking areas, and landscaping;

- d) To promote businesses, industries and commercial activities by providing safe, convenient, attractive parking facilities and environments; and
- e) To encourage the use of efficient forms of transportation.

#### **7.4.5 *Discouraging Subsidized Parking in Public Realm***

Subsidized parking in public roads and spaces, especially in urban areas with high traffic density or having likely projected high traffic density should be discouraged to reduce private vehicle usage and inducing a modal shift towards public transport. Parking management may be used as a demand management tool rather than a supply based tool, with the following considerations:

- a) Discouragement to the use of car as a feeder or a general mode of transport, with park and ride facilities being only at stations of mass rapid transport system (MRTS).
- b) Providing parking only for servicing rather than for access, and only emergency vehicle access to be provided which can be done through provision of mountable kerbs, etc, on pedestrian dominated streets.
- c) No free or subsidized parking in public space and actual parking cost to be defined by market forces.
- d) Enforcement of parking caps in areas with mass rapid transport access.
- e) Park once-and-walk facilities in busy markets and residential/mixed use areas.
- f) Strict enforcement of parking through self-regulating design.

#### **7.4.6 *Providing Neighbourhood Connectivity, Walkability and Safety***

At the site design and block design level, several measures should be taken for reducing transportation demand and promoting walkability, and ensuring that the neighbourhood is a safe walkable place. These measures should include the following:

- a) Vertical mixing of housing and community based uses to ensure vibrancy and safety.
- b) Based on local climate, minimum 2 h daylight access to neighbouring buildings to be ensured through provision of required street width-to-height ratios, in accordance with Part 3 'Development Control Rules and General Building Requirements' of the Code.
- c) *Block sizes and paseos*– For blocks where any one side is greater than 200 m in length, a public access cut-through for pedestrians and non-motorized transport (NMT) shall be provided. This ensures connectivity and walkability in the neighbourhood enabling short local trips to be made on foot.
- d) The setbacks and boundary wall for commercial properties should be designed so as to also promote safety and encourage pedestrian communication.

#### **7.4.7 *Ecology of Streets***

As streets constitute about 20 to 25 percent of the impervious cover of the city, they have a large detrimental effect on the heat island effect and ecological character of a city. The following design components should be integrated in street design:

- a) Planting of trees as an essential component for all streets to provide shade to pedestrians and reduce solar gain.
- b) Use of high albedo (diffused reflectivity) materials for paving and increasing greenery around to reduce heat island effect.
- c) Decreasing impervious surfaces through permeable paving, tree planting zones, etc, to increase groundwater infiltration and prevent seasonal flooding.
- d) Integrate natural storm water filtration and absorption into street design through bio-filtration beds, bio-swales and detention ponds.

## 7.5 External Lighting Design

### 7.5.1 Landscape Lighting Design – Allowable Lighting Power Density (LPD)

Light pollution can disrupt circadian rhythms and melatonin production, which has been linked to serious health concerns. Reasonable use of outdoor lighting restores dark night skies and preserves the ambiance of the night. Whether outdoor light is directly adjacent to a species habitat or located at some distance is an important consideration, as through sky glow, the combined effects of artificial lighting on vast numbers of nocturnal species have the potential to disrupt the functioning of entire ecosystems by disturbing balances in competition and predation. The landscape lighting should be designed such that light fixtures emit minimum light as per the specified total fixed lumens and only light the areas as required for safety and comfort. In addition, the lighting shall be efficient complying with the requirements of maximum LPD given in Table 7.

**Table 7 Maximum Lighting Power Densities for Building Exteriors**  
(Clauses 7.5.1 and 7.5.3)

SI No. (1)	Area to be Lit (2)	LPDs Max (3)
i)	<i>Uncovered parking areas:</i>	
	a) Parking lots and drives	1.6 W/m <sup>2</sup>
ii)	<i>Building grounds:</i>	
	a) Walkways less than 3 m wide	3.28 W/linear metre
	b) 1) Walkways 3 m wide or greater 2) Plaza Areas 3) Special feature areas	2.15 W/m <sup>2</sup>
	c) Stairways	

iii)	<i>Building entrances and exits:</i>	
	a) Main entries	98.52 W/linear metre of door width
	b) Other doors	65.68 W/linear metre of door width
iv)	<i>Canopies and overhangs:</i>	
	a) Canopies (free standing and attached and overhangs)	13.45 W/m <sup>2</sup>
v)	<i>Outdoor sales:</i>	
	a) Open areas (including vehicle sales lots)	5.38 W/m <sup>2</sup>
	b) Street frontage for vehicle sales lots in addition to open areas allowance	65.68 W/linear metre
vi)	Building facades	2.15 W/m <sup>2</sup> for each illuminated wall or surface or 16.42 W/linear metre for each illuminated wall or surface length
vii)	Automated teller machines (ATMs) and night depositories	270 W per location plus 90 W per additional ATM per location
viii)	Entrances and gatehouse inspection stations at guarded facilities	13.45 W/m <sup>2</sup> of uncovered areas covered areas are included under the canopies and overhangs
ix)	Loading areas for law enforcement, fire, ambulance and other emergency service vehicles	5.38 W/m <sup>2</sup> of uncovered areas covered areas are included in the canopies and overhangs
x)	Drive-up windows at fast food restaurants	400 W per drive-through
xi)	Parking near 24 h retail entrance	800 W per main entry
xii)	Landscaped areas, including individual house courtyards, terraces	2.15 W/m <sup>2</sup>

---

### 7.5.2 External Signage Design

External signage may be designed to address the following main issues related to overall sustainability:

- a) The signage shall be classified as external lit and internal lit and further classified based on functional requirements such as emergency, way finding, etc. The

requirements of each type of signage are different and should be evaluated based on the same. The recommended lighting power density is 130 W/m<sup>2</sup>, maximum for internally illuminated signage, and 25 W/m<sup>2</sup>, maximum for externally illuminated signage.

- b) Illuminated signage forms a substantial part of upward directed lighting. Efforts should be made to shield the lighting.
- c) Paints, adhesives, etc, used in the signage should be of low VOC.
- d) Fabrication of the signage should be using materials locally available and having a recycled content.

### 7.5.3 External Lighting

The facades may be lit with fixtures that are shielded, with less than 10 percent lumens above 90° from the nadir (see Fig. 12) and the lighting power density of the facade lighting may be as given in Table 7.

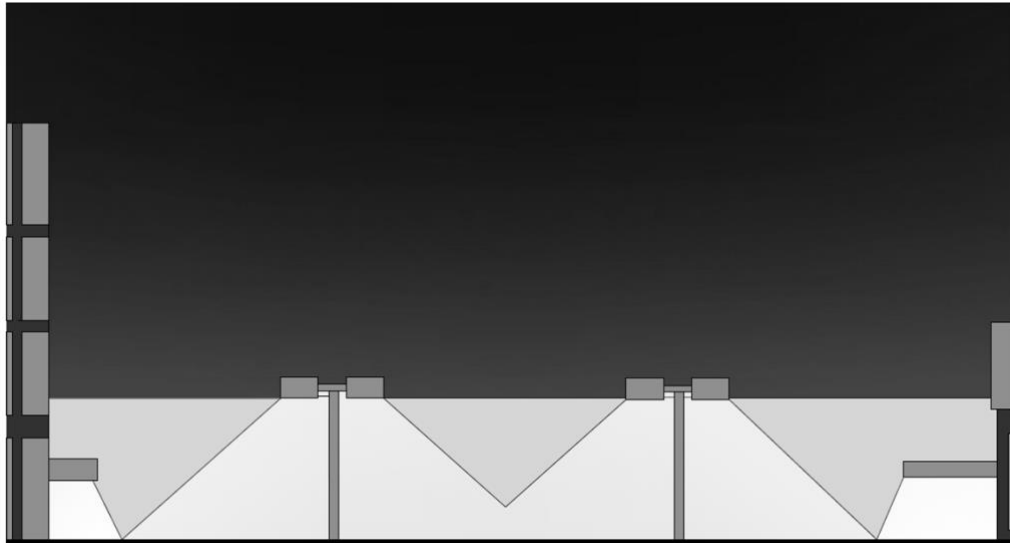

FIG. 12 FACADE LIGHTING USING SHIELDED FIXTURES

### 7.5.4 Light Trespass Allowance

The light trespass allowance may vary for different site surroundings, and a light should also vary for different settings depending upon the requirements. The site settings may be kept as,

- a) *Dark* – For rural setting.
- b) *Low lighting setting* – For residential areas/sub-urban areas and townships.
- c) *Medium lighting setting* – For medium rise buildings, high rise buildings, commercial/office areas and high density for non-commercial area.
- d) *High lighting setting* – For malls, entertainment areas and city centre areas.

## 8 ENVELOPE OPTIMIZATION

### 8.1 Building Envelope

The building envelope acts as the interface between indoor and external climatic conditions. It potentially regulates the building climatic response. The building envelope should be designed to conserve energy substantially. Well designed building envelope maximizes daylight, natural ventilation (access to fresh air) and views to the exterior, and enables to modulate solar heat gain and control/reduce noise. The building envelope may also be designed to integrate systems for renewable energy and rainwater harvesting. In general, the design strategies drawn from long experience in the country in its various climatic zones may be taken into account (see Annex A for guidance).

Building envelope components and their configuration largely determine the amount of heat gain or loss and wind that enters inside the building and extent of natural ventilation in the building. The primary components of building envelope which affect the performance of a building are,

- a) walls,
- b) roof (including skylights and clerestories),
- c) fenestration (openings with or without glazing),
- d) floor, and
- e) surface finishes.

#### 8.1.1 Walls

Walls are a major part of the building envelope, which are exposed to external environment conditions such as solar radiation, outside air temperature, wind and precipitation. The construction of wall and thereby its heat storing capacity and heat conduction property has a major impact on indoor thermal comfort in naturally ventilated buildings and on cooling loads in air conditioned buildings. The wall material, thickness, finishes should be selected according to climate zone and building's comfort requirement. Wall properties that determine heat transfer are thermal conductivity, thermal resistivity, thermal absorptivity, emissivity, thermal reflectivity and thermal capacity (see 2).

##### 8.1.1.1 *Enhancement of thermal performance of walls*

Thermal performance of walls can be improved by following ways:

- a) *Thermal insulation (applying insulation on wall surface)*—Thermal insulation plays an important role in reducing the thermal conductance or  $U$  value of walls. The effect of insulation is to reduce heat gain and heat loss. Insulation should always be placed on the hotter side of the surface. In hot climate zone, insulation should be placed on the external side of wall composition. Insulation also controls the interior mean radiant temperature (MRT) by isolating the interior surfaces from the



impacts of exterior conditions. Insulation along with infiltration control is important for reducing heating and cooling loads in simple occupancy (skin) load dominated buildings such as residences. In buildings, that are internal load dominated such as offices with high equipment load, the insulation thickness and properties should be determined based on thermal performance analysis including the role of insulation in reducing cooling energy consumption, particularly in hot and dry, composite and warm humid climates. Thermal insulation may be made from a variety of materials and in several forms. Broadly they may be divided into following five categories:

- 1) Rigid or semi rigid blocks and boards (such as, mineral wool, expanded polystyrene boards);
- 2) Boards with impact or weather resistant surfaces suitable as exterior grade material;
- 3) Loose fill (such as, cellulose, fibre glass);
- 4) Foam and dry spray (such as, polyurethane or polyisocyanurate); and
- 5) Blankets, felts or sheets (such as, fibre glass, mineral wool, closed cell flexible elastomeric foam).

When specifying insulation, its key properties such as thickness, density, thermal resistivity/thermal conductivity value at specified temperature, long term thermal retention, fire resistance, moisture resistance (structure open/closed cell), water vapour diffusion resistance, etc should be specified. Insulation should be applied as per manufacturers' recommendations and in a manner so that it achieves rated insulation in terms of thermal resistance or  $R$  value. Damaging or compressing the insulation reduces the effective  $R$  value and compromises thermal performance of the construction assembly.

- b) *Thermal mass (increasing wall thickness)* – Thermal mass in walls enables time delay in impact of external environment on internal conditions. Thermally massive walls have high thermal capacity, and thermal storage capacity increases with increasing compactness, density and specific heat capacity of the materials. Walls (and other building elements such as roof and floor) can be used for thermal storage. The effectiveness of storing heat or coolness can be increased by creating a flow of fluid through the storage media.

Thermal mass is particularly effective in hot–dry climate with larger diurnal range. The building mass stores heat during daytime when outside temperature is high, and releases it to the inside space during night when outdoor temperature is cooler. Thermal mass is also used in storing heat during daytime in cold climates, to release it into the space during night, to warm it up when outdoor conditions are colder. Materials such as concrete, brick and water have high thermal storage capacity and can be used for such application. Storage mass exposed to direct sunlight should be dark in colour to allow larger absorption. It is generally more efficient to have thicker rather than thinner storage mass. The optimum thickness varies between 100 mm and 200 mm.

NOTE – There are ongoing developments based on research, regarding use of improvised materials with special properties such as phase changing characteristics which may be considered in future along with their implications from sustainability point of view.

- c) *Air cavities (Providing air cavities in walls)* – Air cavities in wall reduces heat gain factor. Performance is improved if the cavity is ventilated. Heat is transmitted through air cavity by convection and radiation. Cavity represents resistance that is not proportional to the thickness of the cavity. For thicknesses greater than 20 mm, the resistance to heat flow is nearly constant. Air cavity, however, may not be treated as replacement for higher insulation, where needed as per the design requirements.
- d) *Surface finishes (Applying light coloured paints on walls)* – Surface colour and finish plays an important role in heat gain and loss from a structure. If external surface of a building is painted with light colour, it will reflect solar radiation. But if the emissivity of the surface colour in the long wave region is also high, the heat flux into the building is considerably reduced. For example, whitewash has a lower reflectivity than aluminium, but will stay cooler when exposed to high solar radiation, due to its high emissivity at low temperatures. The effect of colour on external surfaces is more evident in lighter structure, which offers low resistance to heat flow, and because of low thermal capacity. Ongoing research has made possible paints that are dark but reflect most off infrared (IR) radiation, thereby preventing excessive heat gain.

### 8.1.2 Roofs

The roofs of buildings receive most of heat throughout the day. Predominantly used construction practices in the country especially in urban areas, mainly involve reinforced cement concrete (RCC) as the roofing element, which has high thermal conductivity. If the roof is exposed to solar heat, the temperature inside will also rise as the day progresses. When buildings are air conditioned, the purpose of the system is to maintain inside the building, a lower temperature than the ambient. If the roof slab is exposed to solar heat, it will allow continuous heat inside the building which in turn will add to the air conditioning load. If the roof is protected from heat incidence by suitably insulating the roof from the heat, the conditions inside can be controlled to a large extent so that the living environment inside the building remains below the ambient temperature throughout the day. The function of roof insulation is to insulate the building against heat inflow from outside during the day. The options for roof insulation are given in **8.1.2.1** to **8.1.2.2**. The overall thermal transmittance from the exposed roof should be kept as minimum as possible and under normal conditions, the desirable value should not exceed  $0.58 \text{ W}/(\text{m}^2 \text{ }^\circ\text{C})$ . The ceiling surface of floors which are not to be air conditioned may be suitably insulated to give an overall thermal transmittance not exceeding  $1.16 \text{ W}/(\text{m}^2 \text{ }^\circ\text{C})$ . Some traditionally adopted methods of roof construction like stone *Patti* and jack-arched roof may be used after evaluating their thermal performance. Mechanism to shade the roof with vegetation will help a great deal in lowering solar exposures.

### 8.1.2.1 Over-deck and Under-deck insulation

In this system a thermal barrier or insulation is provided over RCC roof, so that the amount of heat of the sun reaching the RCC slab of the roof is substantially reduced to prevent the slab from getting excessively heated up. In contrast, if the thermal barrier is provided under RCC roof, as in under-deck insulation, some heat passes through it and heats up the ambience of the room. This decreases the comfort level of the room and if the building is air-conditioned, increases the air conditioning load. Over-deck insulation is, therefore, considered advantageous over under-deck insulation in hot climates. Over-deck insulation also protects waterproofing system from damage due to thermal stress caused by continuous variation in diurnal and seasonal temperatures. It also acts as a protection against mechanical damage to water proofing systems. Over-deck insulation material should have adequate compression resistance, low water absorption, resistance to high ambient temperature and low thermal conductivity. Over-deck insulation applications may be carried out by either of the following methodologies:

- a) *Use of preformed insulation materials* – Preformed insulation materials used are classified as given below which may be laid, over the roof surface as per the manufacturers' recommendations:
  - 1) Expanded polystyrene sheet.
  - 2) Extruded polystyrene sheet.
  - 3) Polyurethane/polyisocyanurate sheet.
  - 4) Perlite board.
- b) *In-situ application using spray applied polyurethane* – This is applied directly over the roof by spraying. This insulation has advantage of non-interference with internal construction/operational activities of a building, jointless adhesion to the roof surface due to seamless and monolithic nature of spray, and speedy application. *In-situ* spray application involves a mixture of atmospheric air leading to open cell formation and may affect insulation performance over time. Therefore, it is preferable in complex locations where use of rigid boards is difficult or not possible. This insulation needs to be treated with proper water proofing treatment ensuring no water ingress into the insulation, as in case of the waterproofing treatment getting damaged, the water ingress into the insulation may lead to deterioration and adversely affecting the insulation properties.
- c) *Conventional roof insulation practices* – There are a number of traditional roof insulation practices followed in the country which have been effectively employed. These may include mud *phuska* and brick bat *coba*.
- d) *Other traditional practices of roof insulation* – Inverted earthen pots may also be used for roof insulation. In this system burnt clay pots are placed in inverted positions and covered with filler material. The air trapped inside the pots act as insulator and renders insulating property to roof. Suitable water proofing treatment needs to be additionally applied [see also 9.2.4.1.1 (m)]. Cellular concrete may also be used depending on the thermal insulation requirement.

The thermo-physical properties of different roof constructions are given in Table 8 and Table 9 for flat roof and sloped roof, respectively.

**Table 8 Typical Thermal Performance of Flat Roof Constructions**  
(Clause 8.1.2.1)

SI No.	Specification of Roof	U Values W/(m <sup>2</sup> .K)
(1)	(2)	(3)
i)	100 mm RCC	3.59
ii)	100 mm RCC + 100 mm lime concrete	2.78
iii)	100 mm RCC + 50 mm foam concrete + waterproofing	1.08
iv)	50 mm RCC + 25 mm expanded polystyrene	1.08
v)	50 mm expanded polystyrene + 50 mm RCC + waterproofing	0.62
vi)	25 mm expanded polystyrene + 50 mm RCC	1.09
vii)	100 mm RCC + 50 mm cinder concrete + 50 mm brick tile	2.07
viii)	100 mm RCC + 75 mm cinder concrete + 50 mm brick tile	1.76
ix)	115 mm RCC + 50 mm mud <i>phuska</i> + 50 mm brick tile	2.31
x)	115 mm RCC + 75 mm mud <i>phuska</i> + 50 mm brick tile	2.01
xi)	150 mm clay unit	3.15
xii)	137.5 mm clay unit	2.99
xiii)	150 mm clay unit + 100 mm lime concrete	2.21
xiv)	137.5 mm clay unit + 100 mm lime concrete	2.14
xv)	100 mm cellular unit + 85 mm lime concrete	2.27
xvi)	125 mm cord unit + 85 mm lime concrete	2.13
xvii)	154 mm lime concrete using stone aggregate + 76 mm stone slab	3.07
xviii)	88.9 mm concrete using brick aggregate + 25.4 mm kota stone slab on each side	3.65
xix)	50.8 mm lime concrete using ballast aggregate + 114 mm reinforced brick and bitumen wash on top	2.45
xx)	50.8 mm lime concrete using brick ballast aggregate + 50.8 mm RCC slab + bitumen wash on top surface	4.02
xxi)	100 mm RCC + Inverted clay pots with mud <i>phuska</i>	2.344
xxii)	100 mm RCC + Extruded polystyrene 25mm-36kg/m <sup>3</sup>	0.749
xxiii)	100 mm RCC + Extruded polystyrene 30mm-36kg/m <sup>3</sup>	0.658
xxiv)	100 mm RCC + Extruded polystyrene 40mm-36kg/m <sup>3</sup>	0.528
xxv)	100 mm RCC + Extruded polystyrene 60mm-36kg/m <sup>3</sup>	0.380
xxvi)	100 mm RCC + Extruded polystyrene 75mm-36kg/m <sup>3</sup>	0.312
xxvii)	100 mm RCC + Expanded polystyrene 25mm-24kg/m <sup>3</sup>	0.931
xxviii)	100 mm RCC + Expanded polystyrene 30mm-24kg/m <sup>3</sup>	0.823
xxix)	100 mm RCC + Expanded polystyrene 40mm-24kg/m <sup>3</sup>	0.670
xxx)	100 mm RCC + Expanded polystyrene 60mm-24kg/m <sup>3</sup>	0.482
xxxi)	100 mm RCC + Expanded polystyrene 75mm- 24 kg/m <sup>3</sup>	0.409
xxxii)	100 mm RCC + Phenolic foam 25mm-32 kg/m <sup>3</sup>	0.725

xxxiii)	100 mm RCC + Phenolic foam 30mm-32 kg/m <sup>3</sup>	0.641
xxxiv)	100 mm RCC + Phenolic foam 40mm-32 kg/m <sup>3</sup>	0.511
xxxv)	100 mm RCC + Phenolic foam 60mm-32 kg/m <sup>3</sup>	0.363
xxxvi)	100 mm RCC + Phenolic foam 75mm-32 kg/m <sup>3</sup>	0.301
xxxvii)	100 mm RCC + Polyurethane spray 25mm-42 + 2 kg/m <sup>3</sup>	0.664
xxxviii)	100 mm RCC + Polyurethane spray 30mm-42 + 2 kg/m <sup>3</sup>	0.579
xxxix)	100 mm RCC + Polyurethane spray 40mm-42 + 2 kg/m <sup>3</sup>	0.460
xl)	100 mm RCC + Polyurethane spray 60mm-42 + 2 kg/m <sup>3</sup>	0.319
xli)	100 mm RCC + Polyurethane spray 75mm-42 + 2 kg/m <sup>3</sup>	0.259
xlii)	100 mm RCC + Polyisocyanurate spray 25mm-42 + 2 kg/m <sup>3</sup>	0.664
xliii)	100 mm RCC + Polyisocyanurate spray 30mm-42 + 2 kg/m <sup>3</sup>	0.579
xliv)	100 mm RCC + Polyisocyanurate spray 25mm-42 + 2 kg/m <sup>3</sup>	0.460
xlv)	15 mm cement plaster + 150 mm RCC + 100 mm brick bat coba + 43 mm polyurethane of 36 kg/m <sup>3</sup> + brick tiling	0.409
xlvi)	15 mm cement plaster + 150 mm RCC + 100 mm brick bat coba + 71 mm expanded polyurethane of 24 kg/m <sup>3</sup> + brick tiling	0.409
xlvii)	15 mm cement plaster + 150 mm RCC + 100 mm brick bat coba + 58 mm extruded polyurethane of 29 kg/m <sup>3</sup> + brick tiling	0.409
xlviii)	15 mm cement plaster + 150 mm RCC + 100 mm brick bat coba + 140 mm exfoliated vermiculite of 264 kg/m <sup>3</sup> + brick tiling	0.409
xlix)	15 mm cement plaster + 150 mm RCC + 100 mm brick bat coba + 43 mm polyisocyanurate of 32 kg/m <sup>3</sup> + brick tiling	0.409
l)	15 mm cement plaster + 150 mm RCC + 100 mm brick bat coba + 73 mm polyurethane of 36 kg/m <sup>3</sup> + brick tiling	0.261
li)	15 mm cement plaster + 150 mm RCC + 100 mm brick bat coba + 122 mm expanded polystyrene of 24 kg/m <sup>3</sup> + brick tiling	0.261
lii)	15 mm cement plaster + 150 mm RCC + 100 mm brick bat coba + 98 mm extruded polystyrene of 29 kg/m <sup>3</sup> + brick tiling	0.261
liii)	15 mm cement plaster + 150 mm RCC + 100 mm brick bat coba + 240 mm exfoliated vermiculite of 264 kg/m <sup>3</sup> + brick tiling	0.261
liv)	15 mm cement plaster + 150 mm RCC + 100 mm brick bat coba + 73 mm polyisocyanurate of 32 kg/m <sup>3</sup> + brick tiling	0.261

**Table 9 Typical Thermal Performance of Sloped Roof Constructions**  
(Clause 8.1.2.1)

SI No.	Specification of Sloped Roof	U Values W/(m <sup>2</sup> .K)
(1)	(2)	(3)
i)	0.625 cm AC sheet	5.47
ii)	0.625 cm AC sheet + 2.5 cm air space + insulating board	2.44
iii)	0.625 cm AC sheet + air space + 5 cm fibre glass + 0.625 hard board	1.40

iv)	0.625 cm AC sheet + air space + 5 cm sandwich of fibreboard/ expanded polystyrene	0.65
v)	0.625 cm AC sheet + air space + 2.5 cm sandwich of fibreboard/ expanded polystyrene	1.22
vi)	0.3 cm GI sheet	6.16
vii)	2.5 cm tile + 2.5 cm bamboo reinforcement	3.56
viii)	5 cm tile + 2.5 cm bamboo reinforcement	3.20
ix)	2.5 cm thatch roof + 2.5 cm bamboo reinforcement	2.38
x)	5 cm thatch roof + 2.5 cm bamboo reinforcement	1.69
xi)	Mangalore tiles on wooden rafters	4.07

NOTE - Thermal conductivity values are indicative and many other/traditional practices may be employed for achieving desired thermal properties.

Thermal properties of some commonly used insulating materials and building materials are given in Table 10.

**Table 10 Thermal Properties of Building and Insulating Materials  
at Mean Temperature of 50 °C  
(Clause 8.1.2.1)**

SI No.	Type of Material	Density	Thermal Conductivity	Specific Heat Capacity
(1)	(2)	kg/m <sup>3</sup> (3)	W/mK (4)	kJ/kgK (5)
i) Building materials:				
1)	Burnt brick	1 820	0.811	0.88
2)	Mud brick	1 731	0.750	0.88
3)	Dense concrete	2 410	1.74	0.88
4)	RCC	2 288	1.58	0.88
5)	Limestone	2 420	1.80	0.84
6)	Stale	2 750	1.72	0.84
7)	Reinforced brick	1 920	1.10	0.84
8)	Brick tile	1 892	0.798	0.88
9)	Lime concrete	1 646	0.730	0.88
10)	Mud <i>phuska</i>	1 622	0.519	0.88
11)	Cement mortar	1 648	0.719	0.92
12)	Cement plaster	1 762	0.721	0.84
13)	Cinder concrete	1 406	0.686	0.84
14)	Foam slag concrete	1 320	0.285	0.88
15)	Gypsum plaster	1 120	0.512	0.96
16)	Cellular concrete	704	0.188	1.05
17)	AC sheet	1 520	0.245	0.84
18)	GI sheet	7 520	61.06	0.50

19)	Timber	480	0.072	1.68
20)	Timber	720	0.144	1.68
21)	Plywood	640	0.174	1.76
22)	Glass	2 350	0.814	0.88
23)	Alluvial clay (40 percent sands)	1 958	1.211	0.84
24)	Sand	2 240	1.74	0.84
25)	Black cotton clay (Madras)	1 899	0.735	0.88
26)	Black cotton clay (Indore)	1 683	0.606	0.88
27)	Tar felt (2.3 kg/m <sup>2</sup> )		0.479	0.88
28)	AAC block of 200 mm	749.6	0.089	1.0
29)	Fly ash clay brick	1240	0.44	
30)	Sand lime brick	1820	0.90	
31)	Vermiculite tiles	1254	0.432	
32)	Perlite concrete	1000	0.261	
33)	Expanded polystyrene concrete	932	0.231	

## ii) Insulating materials:

1)	Expanded polystyrene	16.0	0.038	1.34
2)	Expanded polystyrene	24.0	0.035	1.34
3)	Expanded polystyrene	34.0	0.035	1.34
4)	Foam glass	127.0	0.056	0.75
5)	Foam glass	160.0	0.055	0.75
6)	Foam concrete	320.0	0.070	0.92
7)	Foam concrete	400.0	0.084	0.92
8)	Foam concrete	704.0	0.149	0.92
9)	Cork slab	164.0	0.043	0.96
10)	Cork slab	192.0	0.044	0.96
11)	Cork slab	304.0	0.055	0.96
12)	Rock wool (unbonded)	92.0	0.047	0.84
13)	Rock wool (unbonded)	150.0	0.043	0.84
14)	Mineral wool (unbonded)	73.5	0.030	0.92
15)	Glass wool (unbonded)	69.0	0.043	0.92
16)	Glass wool (unbonded)	189.0	0.040	0.92
17)	Resin bonded mineral wool	48.0	0.042	1.00
18)	Resin bonded mineral wool	64.0	0.038	1.00
19)	Resin bonded mineral wool	99.0	0.036	1.00
20)	Resin bonded mineral wool	16.0	0.040	1.00
21)	Resin bonded mineral wool	24.0	0.036	1.00
22)	Exfoliated vermiculite (loose)	264.0	0.069	0.88
23)	Asbestos mill board	1 397.0	0.249	0.84
24)	Hard board	979.0	0.279	1.42
25)	Straw board	310.0	0.057	1.30
26)	Soft board	320.0	0.066	1.30
27)	Soft board	249.0	0.047	1.30

28)	Wall board	262.0	0.047	1.26
29)	Chip board	432.0	0.067	1.26
30)	Chip board (perforated)	352.0	0.066	1.26
31)	Particle board	750.0	0.098	1.30
32)	Coconut pith insulation board	520.0	0.060	1.09
33)	Jute fibre	329.0	0.067	1.09
34)	Wood wool board (bonded with cement)	398.0	0.081	1.13
35)	Wood wool board (bonded with cement)	674.0	0.108	1.13
36)	Coir board	97.0	0.038	1.00
37)	Saw dust	188.0	0.051	1.00
38)	Rice husk	120.0	0.051	1.00
39)	Jute felt	291.0	0.042	0.88
40)	Asbestos fibre (loose)	640.0	0.060	0.84
41)	Closed cell flexible elastomeric foam - NBR	40-55	0.043	1.20

For thermal performance of flat and sloped roofs with use of various other considerations of materials and for thermal properties of building and insulating materials, refer to good practice [11(2)] and SP41 'Handbook on Functional Requirements of Buildings'.

e) *Other over-deck systems that minimise heat gains* – There are other systems employing use of highly reflective and emissivity coatings that stay cooler in the summer thereby reducing energy costs, improving occupant comfort, cutting maintenance costs, increasing the life of the roof, and contributing to the reduction of heat island effect. Roofs with slopes less than 20° slope have a minimum initial solar reflectance of 0.70 and minimum emittance of 0.75. Cool roofs should be designed to have a minimum solar reflectance of 0.70 and a minimum thermal emittance of 0.75 or alternatively should achieve a minimum solar reflective index (SRI) of 82. Various types of cool roof systems are:

- 1) *Roof coatings* – These may be field applied or factory applied. Field applied roof coatings are applied directly onto the roof surface and may require an appropriate primer. Factory applied coatings are applied in factory and include coatings applied to metal sheets. Specialized white elastomeric coatings may be used for sloped roofs and cool colour polymer coatings may be used for roof tiles, and these can be sprayed on existing roofs.
- 2) *Broken china mosaic terracing* – Properly sized broken pieces of glossy glazed tiles may be used as a cost effective cool roofing option.
- 3) *Cool colours* – Cool colour roofing materials are created by integrating pigments that reflect infrared energy, even though their colour may still absorb some of the visible spectrum. In this way, roofing products can be dark coloured and still be cool.
- 4) *Traditional methods* – Lime wash also renders similar property but has limited life and has to be reapplied.



Issues of excessive glare do arise with white roof coatings.

### **8.1.2.2 Green roof system**

Green roofs have the potential to improve the thermal performance of a roofing system through shading, insulation, evapotranspiration and thermal mass, thus reducing energy demand of building for space conditioning. The green roof moderates the heat flow through the roofing system and helps in reducing the temperature fluctuations due to changing outside environment. If widely used, green roofs can reduce the problem of heat island effect which in turn reduces the energy consumption in urban areas. Green roof systems comprise a lightweight growing medium, plants and a root repellent layer in addition to the regular components of a roof. The additional components and thickness of the growing medium provides thermal insulation, while the green cover lowers ambient temperatures through evapotranspiration. Issues related to dead weight and water proofing should be considered while designing roof. There are three types of green roofs, as follows:

- a) *Intensive green roof* – It is like a conventional garden or park with almost no limit on the type of available plants including trees and shrubs.
- b) *Extensive green roof* – It is designed for little maintenance or human intervention once it is established.
- c) *Modular block green roof* – It is designed in modular units which interlock and each module contains drainage systems and plants.

Use of photovoltaic panels for renewable energy (see **8.3.2**) can also be advantageously used for their effect on shading of roof top.

### **8.1.3 Fenestration**

**8.1.3.1** Of all the elements of building envelope, windows and glazed areas are most vulnerable to heat gains. Windows are required to bring inside natural daylight and wind, however, with light it also bring in heat. Proper location, sizing and detailing of windows and shading form is therefore a very important aspect in a solar passive building design. Primary factors/components of a window which have significant impact on energy and cost of the building are window size and placement, glazing, frame, shading (external and internal), and screens or *Jalis*.

#### **8.1.3.1.1 Window size and placement**

The following may be taken into consideration:

- a) *Height of window head* – The higher the window head or lintel, the deeper will be the penetration of daylight.

- b) *Sill height (height from floor to the bottom of the window)* – The optimum sill for good illumination as well for good ventilation should be between the workspace and head level of a person. For carrying out any task, the suitable work plane levels shall be in accordance with 4.1.3.3 of Part 8 'Building Service, Section 1 Lighting and Natural Ventilation' of the Code. Strip windows provide more uniform daylight. Punched windows should be paired with work areas to avoid creating contrasts of light and dark areas. Windows close to task areas should be with optimum visual transmission without glare with good insulation performance as they may be source of thermal discomfort. Small horizontal openings close to the floors and the ceiling are extremely effective in reducing the window area to reduce heat ingress and provide adequate daylight levels in the space. In case of larger windows, glazing selection and shading effectiveness are quite important to control glare and heat gain.
- c) *Use of separate apertures for view and daylight* – For good day lighting and glare control, window should have clear glass with a partition for maximum daylight penetration and tinted glass below the clear glass for glare control. The structure in between the two provides a visual break and an opportunity to attach light shelf or shading device.
- d) *Window wall ratio (WWR)* – Window to wall ratio is the net glazing area (window area minus mullions and frame or approximately 80 percent of opening) divided by gross exterior wall area. Gross wall area is the overall area of a wall including openings such as windows and doors, with measurement taken horizontally from outside surface to outside surface and measured vertically from top of the floor to the top of the roof (see Fig. 13).

NOTE – The above represents only one approach in the entire range of window to wall ratio. The issue is primarily of window to wall ratio, and not window to glazing ratio.

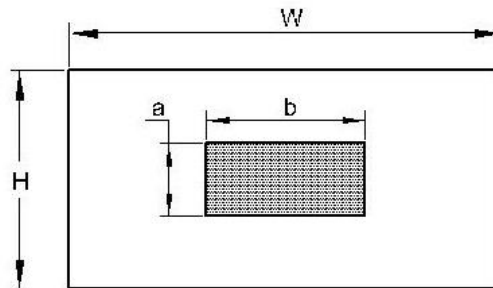

$$WWR = \frac{a \cdot b}{w \cdot h}$$

FRONT ELEVATION OF A TYPICAL WALL

FIG. 13 WINDOW WALL-AREA

Screens make effective windows which reduce heat ingress and yet allow the air movement.

### 8.1.3.1.2 Glazing

The most commonly used glazing material in openings is glass, though recently polycarbonate sheets are being used for skylights. The primary properties of glazing that impact energy use in buildings are,

- a) visible transmittance (affecting daylight),
- b) visible reflectance (affecting heat and light reflection),
- c) thermal transmittance or  $U$  value (affecting conduction heat gains),
- d) solar heat gain (affecting direct solar gain),
- e) spectrum selectivity (affecting daylight and heat gain),
- f) glazing material, and
- g) glazing colour (affecting the thermal and visual properties of glazing systems).

Use of insulated glazing units (IGU) may be considered in appropriate cases. IGU are hermetically sealed, multiple pane assemblies consisting of two or more glazing layers held and bonded at their perimeter by a space bar typically containing a desiccant material. The glazing used in IGUs may be clear, tinted or coated or reflective. The spacer serves to separate the panes of glass and to provide a surface for primary and secondary sealant adhesion. As heat transfer at the edge of the IGU is greater than its centre, the choice of material for spacer is critical to the performance of IGU. The hermetically sealed space between glass panes may be filled with dry air or other alternatives such as argon and krypton.

While selecting a glazing, attention should be given to the following:

- 1) Selecting between dual pane and single pane glazing.
- 2) Selecting a spectrally selective glazing (to keep off infra red and permit visible light).
- 3) Balancing the conflict between glare and light.
- 4) Trading off window size and glazing selection.
- 5) Dark or tinted glass may not necessarily provide good solar control.
- 6) Not depending on glazing alone to reduce heat gain and discomfort.
- 7) Selection of frame for glazing (see **8.1.3.1.3**).
- 8) Varying the selection and configuration of a glazed facade.

### 8.1.3.1.3 Frame

The type and quality of window frame affects air infiltration and heat gain/heat loss characteristics of windows. Window frames are usually made of aluminium, steel, wood, PVC, RCC, fibreglass or composites of these materials. Wood, fibreglass, RCC and vinyl frames are better insulators than metal. Some frames are designed with internal thermal breaks that reduce heat flow through the frame. These thermally broken frames can resist heat flow considerably better as compared to those without thermal breaks. The sealing between the openings and the window frames, and between the opening sashes of windows and fixed portions, are important as major heat loss happens from this area due

to poor design of sealant material, and should be ensured. Adequate provision shall also be made to ensure that the frames are not susceptible to water ingress in case of driving rain.

For further details, reference may be made to **9.2.3.2**.

#### **8.1.3.1.4** *Shading devices*

Direct sunlight can cause glare. Controls are therefore necessary to allow diffused natural light. Windows shading devices may be employed which help in keeping out the heat, block uncomfortable direct sun, and soften harsh daylight contrasts. Shading devices are also critical for visual and thermal comfort and for minimizing mechanical cooling loads. The three main ways of controlling direct sunlight are:

- a) External shading and screens/*Jalis*,
- b) Internal shading,
- c) Use of solar control glass (spectrally selective), and
- d) Horizontal/vertical or angled louvers.

#### **8.1.3.2** *Design for windows in air conditioned and non air conditioned spaces/mixed mode ventilated spaces*

##### **8.1.3.2.1** *Windows in air conditioned buildings*

Window (including both glazing and frame) affects the energy performance of an air conditioned space by impacting the HVAC energy consumption of the building and also the energy consumption for indoor lighting. Following are major types of energy flow which occur through a window impacting the HVAC energy consumption (see also Fig. 14):

- a) *Non-solar heat losses and gains in the form of conduction, convection, and radiation* – The non-solar heat flow through a window occurs due to the temperature difference between the indoor and outdoor. Window loses heat to the outside during the winter season and gains heat from the outside during the summer season, adding to the heating/cooling load in a building.
- b) *Solar heat gains in the form of radiation* –The direct solar radiation entering into a conditioned space adds to the cooling load in summers and reduces heating load in winters in a building.
- c) *Infiltration* – Infiltration is the unregulated exchange of air between indoors and outdoors through joints and cracks around window frame, sash and glazing. The air tightness of a window depends on both the characteristics of the window such as sash type and overall quality of window construction and the quality of the installation. These air exchanges can significantly influence indoor thermal comfort and consequent heating and cooling loads.

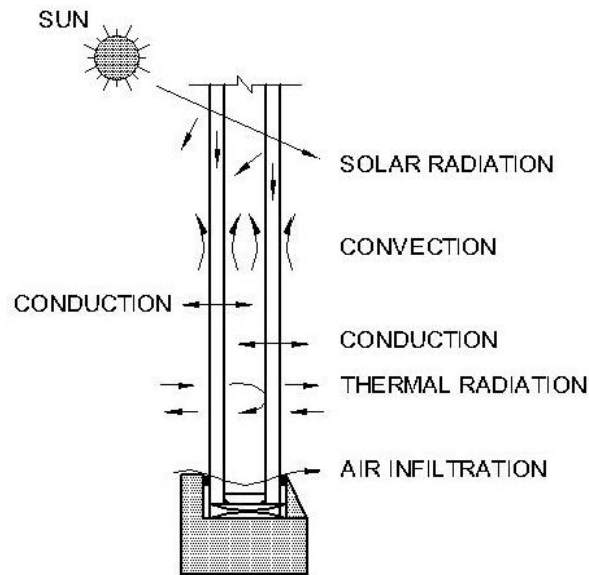

FIG. 14 TYPICAL FLOW OF SOLAR HEAT AND AIR INFILTRATION THROUGH A GLAZED WINDOW SECTION

Following are various parameters, related to the thermal performance of a window which should be considered to achieve energy efficiency in air conditioned building:

- 1) *U value of fenestration* – The  $U$  value of a single pane window is mainly due to the thin films of still air on the interior and moving air on the external glazing surfaces. The glazing itself doesn't offer much resistance to heat flow. Double glazing units, help reduce the  $U$  value by creating still air (insulated) spaces. In addition to the normal double glazed windows, other options aimed at decreasing  $U$  values, such as low-emittance (low-E) coatings and gas fills, may also be available.

A low-E coating is a microscopically thin, virtually invisible, metal or metallic oxide coating deposited on a glazing surface. The coating may be applied to one or more of the glazing surfaces facing an air space in a multiple-pane window. The coating limits radiative heat flow between panes by reflecting heat. In case of air filled panes, the air-gap between window panes can be filled with gases which have better thermal resistance property than air such as argon and krypton.

For details regarding window frames and their thermal performance, reference may be made to **8.1.3.1.3**.

- 2) *Solar heat gain coefficient (SHGC) of fenestration* – Additional glazing layers provides more barriers to solar radiation, thus reducing the SHGC of a window. Tinted glazing, such as bronze and green, provide lower solar heat gain coefficients compared to the clear glass. Spectrally selective glazing, including

some low-E coated glazing with low solar heat gain, block out part of the heat from the sun such as from infra-red radiations, while maintaining higher visible transmittances.

- 3) *Shading and adjusted SHGC* – Exterior or interior shading devices such as awnings, louvered screens, sunscreens, venetian blinds, roller shades, and drapes can complement and enhance the performance of windows with low SHGC. Many shading devices have an advantage that they can be adjusted to vary solar heat transmission with the time of day and season. Adjustable shades can also be integrated to permit some extra heat gain in the winter, if required.

Exterior shading devices are more effective than interior devices in reducing solar heat gain because they block radiation before it passes through a window. Light-coloured shades are preferable to dark ones because they reflect more and absorb less, radiation.

- 4) *Projection factor (PF)* – The projection factor for horizontal overhang and vertical fins may be taken as follows:
  - a) *For horizontal overhang* – Projection factor for overhang is calculated by measuring the depth of the overhang (*A*) and dividing that by the distance from the bottom of the window to the lowest point of the overhang (*B*) (see Fig. 15).
  - b) SHGC for a window having an external shading device can be calculated by multiplying the SHGC value of the window with the *M* factor given in Table 11 for different projection factors for different orientations. The factor *M* is the relative reduction in the annual solar cooling load attributed to the overhangs and/or vertical fins for the given projection factor.
  - c) *For vertical fins* – Projection factor for vertical fin is calculated by measuring depth of the vertical fin and dividing it by the distance from the window jamb to the farthest point of the external shading projection (see Fig. 16).

**Table 11 M Factor for Different Projection Factors for Different Orientations**  
[Clauses 8.1.3.2.1(4)(b) and B-3]

Location	Orientation	Overhang M Factor for the Projection Factor				Vertical Fin M Factor for Projection Factor				Overhang + Vertical Fin M Factor for Projection Factors			
		0.25 to 0.49	0.50 to 0.74	0.75 to 0.99	More than 1.00	0.25 to 0.49	0.50 to 0.74	0.75 to 0.99	More than 1.00	0.25 to 0.49	0.50 to 0.74	0.75 to 0.99	More than 1.00
(1)	(2)	(3)	(4)	(5)	(6)	(7)	(8)	(9)	(10)	(11)	(12)	(13)	(14)
	N	0.88	0.80	0.76	0.73	0.74	0.67	0.58	0.52	0.64	0.51	0.39	0.31

15° North Latitude or greater	E/W	0.79	0.65	0.56	0.50	0.80	0.72	0.65	0.60	0.60	0.39	0.24	0.16
	S	0.79	0.64	0.52	0.43	0.79	0.69	0.60	0.56	0.60	0.33	0.10	0.02
Less than 15° North Latitude	N	0.83	0.74	0.69	0.66	0.73	0.65	0.57	0.50	0.59	0.44	0.32	0.23
	E/W	0.80	0.67	0.59	0.53	0.80	0.72	0.63	0.58	0.61	0.41	0.26	0.16
	S	0.78	0.62	0.55	0.50	0.74	0.65	0.57	0.50	0.53	0.30	0.12	0.04

5) *Impact on lighting energy consumption* – During day time when natural light outside, is available in abundance, window can be utilized as a tool to harness natural light from Sun and sky to light the space. Buildings, in which artificial lighting is integrated with the day lighting, can reduce their energy consumption significantly. Good day lighting in a building depends upon the following factors:

- Window wall ratio (WWR)* – See 8.1.3.1.1(d).
- Visible light transmittance (VLT) of glazing.*
- Day-lighting and window design* – Day lighting is utilization of light from the sun and sky to augment or replace electric light. Appropriate fenestration and lighting controls can be used to modulate daylight admittance and to reduce electric lighting, while meeting the occupants' visual comfort.
- Day-lit perimeter zone for vertical fenestration* – The day-lit zone associated to a window can be defined as an area having a depth which is twice the window height (measured from ground) and having the width which is equal to the window width plus 1.0 m on each of the vertical sides of window as indicated in the Fig. 17.

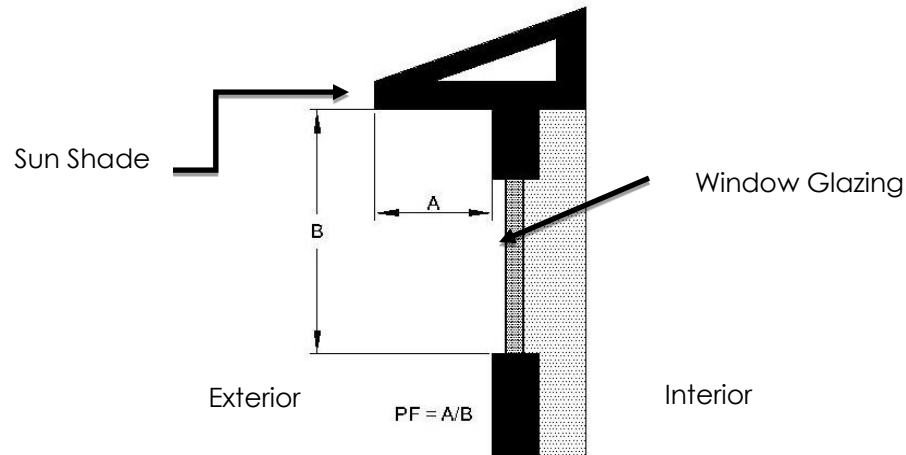

FIG. 15 PROJECTION FACTOR FOR HORIZONTAL OVERHANG FOR A TYPICAL WINDOW SECTION

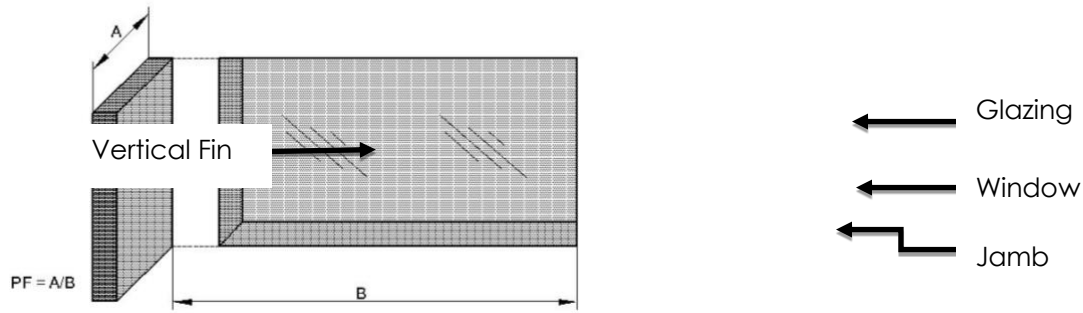
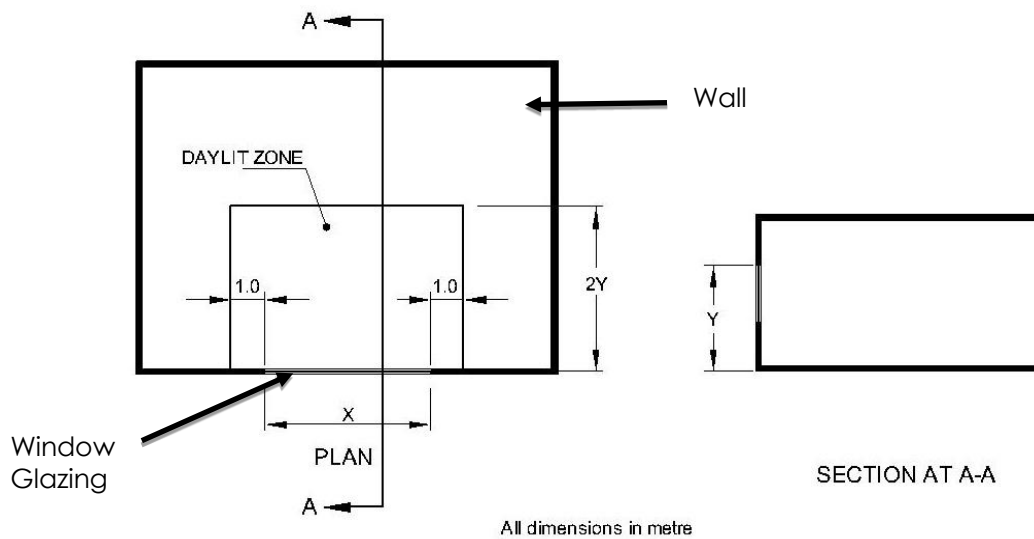

FIG. 16 PROJECTION FACTOR FOR VERTICAL FIN



Dimension of Day-lit perimeter: Depth (m) =  $2 \times Y$ ; Width (m) =  $X + 1 + 1$ .

FIG. 17 DAY-LIT PERIMETER ZONE ASSOCIATED TO A WINDOW

The fenestration area, located above 1.0 m but below 2.2 m is considered as vision window area. The vision window area is usually provided with the glass with lower VLT in order to reduce glare.

The fenestration area located above 2.2 m is considered as daylight window area. Larger the daylight window area more will be the daylight penetration into a space. The daylight window area is usually provided with glass with higher VLT so as to receive daylight to the greater depths of the space. The daylight window area can be designed in form of light shelves, as shown in Fig. 18, which enhance the penetration of daylight. The extent of natural light penetration into the room depends on the colour (reflectance) of the interior wall surfaces, the furnishing colour and partly the colour of the flooring.



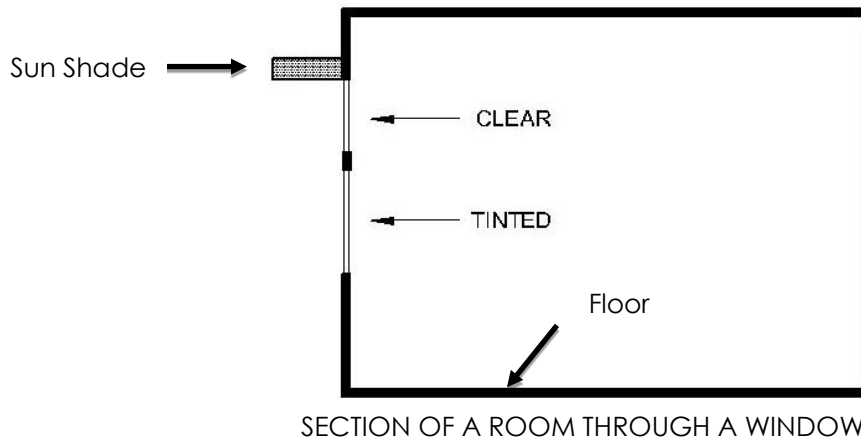

FIG. 18 ARRANGEMENT SHOWING VISION WINDOW AREA AND DAY LIGHT WINDOW AREA

The following should be determined and shall conform to the requirements of this Code:

- a) *U*-value for a fenestration product (including the sash and frame).
- b) The SHGC for a fenestration product (including the sash and frame).
- c) Air leakage through fenestration, shall not exceed 2.0 litre /s.m<sup>2</sup>.
- d) Window wall ratio on a facade, correlated to the visible light transmittance of the glazing which shall not exceed 60 percent.

NOTE – It may be noted that screens make effective windows which reduce heat ingress and yet permit natural ventilation.

#### 8.1.3.2.2 Window design guideline for non-conditioned/mixed mode buildings

The following may be considered in selection of type of windows:

- a) *Horizontal pivot windows* – These produce very effective ventilation because large open areas are created at a separation equivalent to the window height. Air will tend to enter at the lower level and exit *via* the top of the window. These are easily adjustable to provide control of the ventilation rate. These are often used in taller buildings, as both sides of glass can be cleaned from the inside of the building with ease. The main disadvantage of this type of window is that, when opened, the top of the sash interferes with the curtains.
- b) *Vertical pivot windows* – These are less efficient than horizontal pivot windows because the open area is uniformly distributed throughout the height of the window rather than concentrated at the extremes; but these can work well in combinations. There is an advantage that these can be both opened and closed by pushing and are easy to clean from the inside. When fully open these offer a safe vertical barrier. The inward opening section may interfere with curtains when fully open.

- c) *Casement windows* – These offer the same advantages as vertical pivot windows but are susceptible to gusts. The most commonly used are double sided hinged outward opening windows which have great versatility with respect to air flow control. Most casement windows are designed to open outwards, which poses a problem for installation of window air conditioners.
- d) *Top/bottom hung windows* – These are less effective as ventilators than pivot windows as all the opening area is concentrated at one end, the top or bottom of the window.
- e) *Sliding windows* – These have similar characteristics as horizontal or vertical pivot windows. Sliding windows are easy to open; these slide to the side instead of having to be pushed inside/outside. A good seal is important in reducing draughts and energy loss when closed. Cleaning the inside of slider windows is easy, but cleaning the outside may be difficult.
- f) *Tilting top vents* – These provide smaller opening areas than the other systems as these occupy only a relatively small proportion of the window height. However, these can provide good draught-free ventilation, especially in cross-ventilation mode. The inward opening function of tilt and turn windows limit the available space.

The window may also be provided with fixed/sash/sliding/roller insect screens to allow fresh air without the inlet of mosquitoes and other insects through openable windows.

As compared to air-conditioned spaces, the window design in non-conditioned/mixed mode buildings takes a different approach. The glazing system for windows in non-conditioned/mixed mode spaces is usually single pane/panel glazed units as the windows will be opened to allow ventilation. Thus there is less relevance to install double glazing units with low SHGC and *U*-values.

However, in the non-conditioned/mixed mode buildings the shading device plays a crucial role in the thermal performance of a window. Windows on facades, for different orientations, should be provided by the shading devices which can cut the direct incident solar radiation for the critical solar angles.

In the non-conditioned buildings/mixed mode buildings, penetration of direct solar radiation needs to be regulated. The critical Horizontal Solar Angle (HSA) and Vertical Solar Angle (VSA) (see Fig.1) for fenestrations located on the cardinal directions should be regulated by designing appropriate shading devices. The horizontal solar angle at critical hours can be regulated by the vertical fins provided as external shading devices. The vertical solar angle at critical hours can be regulated by the horizontal fins provided as external shading devices.

The maximum permissible WWR on a facade should not exceed 60 percent. Window opening requirements for naturally ventilated low rise residential and office buildings include the following:

- a) In order to allow outside air to enter the space, window openings should be oriented appropriately to optimize heat and solar heat gain.
- b) In order to facilitate cross ventilation, location of window openings should be located opposite to each other on walls parallel to each other.
- c) In order to achieve the required air change per hour in a given space, cross ventilation and stack ventilation mode of natural ventilation should be adopted.

The external shading devices can be designed in various ways to stop the solar radiation entering through the window. Figure19 shows the commonly used shading devices.

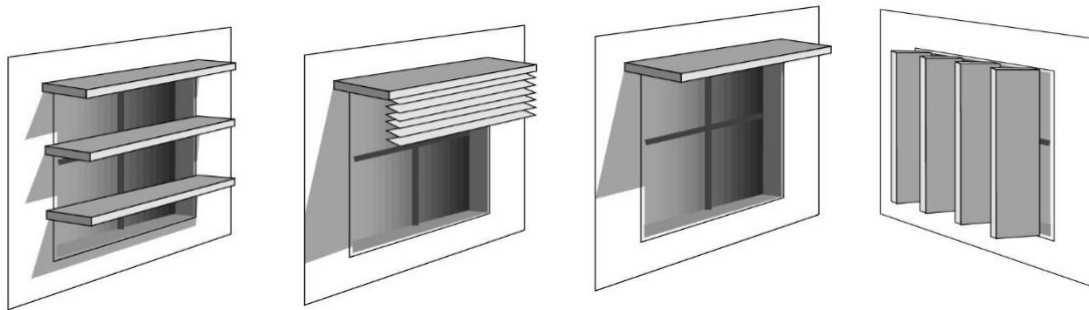

FIG. 19 COMMONLY USED SHADING DEVICES

*Example to design shading device for a window*

Design of shading device for a window of height 1.5 m and width 3.0 m to cut the HSA of 45° and VSA of 60° should be as follows:

- a) *Design of shading device to cut the VSA* – The vertical solar angle of 60° can be cut by providing a single horizontal overhang of length 867 mm or it can be cut by providing two horizontal projections 60 mm thick each of length 415 mm placed at a distance of 720 mm as shown in Fig.20.

The length and spacing can be calculated either by the drafting softwares by graphical method or by manually calculating using the following formula:

Depth of shading device

$$= \text{Spacing between the shading device} \times \tan (90^\circ - \text{VSA})$$

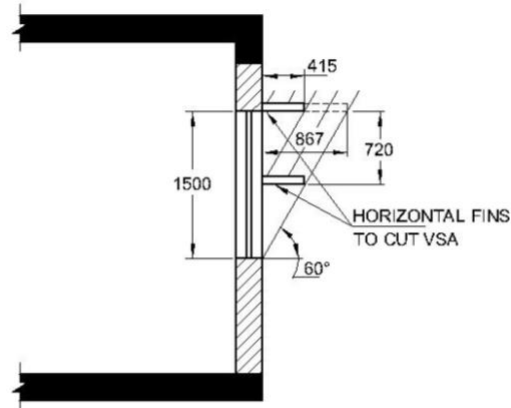

SECTION IN ELEVATION

All dimensions are in millimetres

FIG. 20 DESIGN OF SHADING DEVICE TO CUT VSA

For a given VSA, either of the values for depth or spacing between shading overhangs can be selected to get the value of the other.

- b) *Design of shading device to cut the HAS* – The horizontal solar angle of  $45^\circ$  can be cut by providing a single vertical fin of length 3000 mm or it can be cut by providing four vertical fins 60 mm thick each of length 705 mm placed at a distance of 705 mm as shown in Figure 21.

The length and spacing can be calculated either by the drafting softwares by graphical method or by manually calculating using the formula:

$$\text{Depth of vertical fins} = \text{Spacing between the vertical fins} \times \tan(90^\circ - \text{HSA})$$

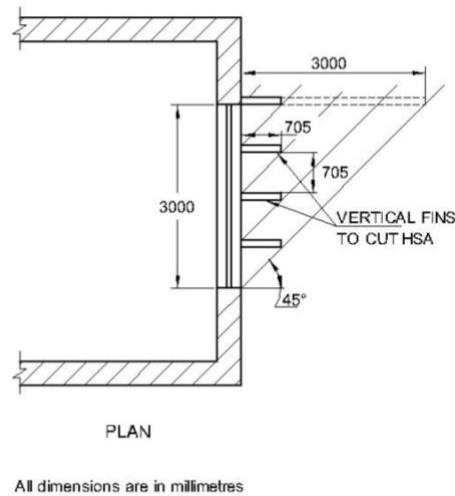

FIG. 21 DESIGN OF SHADING DEVICE TO CUT HSA

For a given HSA either of the values for depth or spacing between vertical fins can be selected to get the value of the other.

It is desirable to break single overhang with larger depth into multiple overhangs of smaller length. It enhances the amount of (diffused) daylight penetration in the space. Figure 22 shows the comparison between amount of daylight penetration for two shading devices, one with single deep overhang and the other with multiple smaller overhangs. Another alternative is use of screens which make effective window/opening protection by reducing heat ingress and yet permitting air movement.

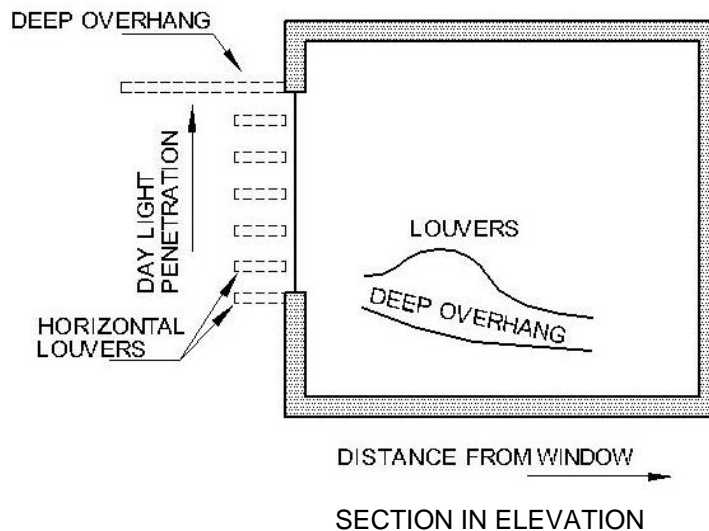

FIG. 22 COMPARISON OF DAYLIGHT PENETRATION WITH USE OF TWO SHADING DEVICES NAMELY DEEP OVERHANGS AND LOUVERS

*Window design for natural ventilation* – Windows are required to provide natural cooling through ventilation. Optimized window design helps to achieve thermal comfort with no additional energy and/or financial investment. Optimized window design helps to reduce dependence on air conditioning where natural ventilation is possible and helps in reducing discomfort in naturally ventilated spaces. Following are the general guidelines for achieving effective natural ventilation:

- 1) Natural ventilated buildings should take advantage of the predominant wind originating from east and west directions to maximize cross ventilation. Stack ventilation can be enhanced by providing openings on the opposite side of the wall, where the inlet opening should be located at the bottom most part of the wall and outlet openings should be on the topmost part of the opposite wall in order to increase the height difference between the two (see Fig. 23).
- 2) Naturally ventilated buildings should have a narrow room width; and it is difficult to naturally ventilate buildings with room depth more than 15m.
- 3) For total area of openings (inlet and outlet) of 20 to 30 percent of floor area, the average indoor wind velocity that may be achieved is around 30 percent of outdoor wind velocity. Even on increasing the size of window further, the maximum indoor wind velocity does not exceed 40 percent of outside wind velocity.

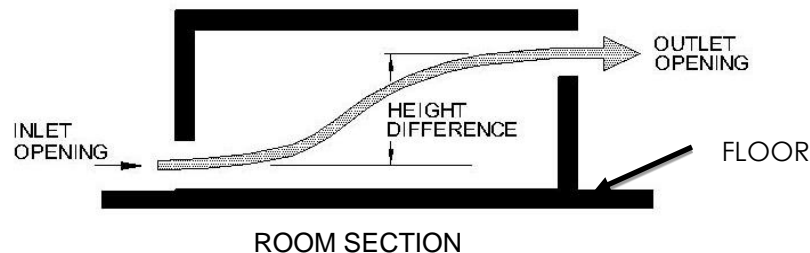

FIG. 23 ARRANGEMENT OF OPENINGS IN WALLS FOR ENHANCED VENTILATION

- 4) To enhance physiological comfort through natural ventilation, the bottom side of the opening may be kept at 85 percent of the height of the room taken from ceiling or as per Table 12 for the corresponding occupant activity.

**Table 12 Critical Height Requirement for Physiological Cooling**

[Clause 8.1.3.2.2(d)]

SI No.	Pattern of Activities	Recommended Height of the Bottom Side of Opening
(1)	(2)	(3)
i)	Sitting on chair	0.75
ii)	Sitting on bed	0.60
iii)	Sitting on floor	0.40

- 5) Clerestory or vented skylight provides an opening for vitiated air to escape through natural buoyant ventilation. The light well of the skylight may also act as a solar chimney to augment natural buoyant flows.
- 6) Openings in lower part of the structure, such as basement windows, should be provided to complete the ventilation system.

## 8.2 Envelope Optimization Methods for Energy Efficiency

Envelope optimization methods are important tools for optimizing the design of building envelope from energy efficiency point of view. Any of the following envelope optimization methods may be employed to achieve the objective:

- a) *Prescriptive method* – This method specifies a set of prescriptive requirements for building systems and components. Compliance with these requirements can be achieved by meeting or exceeding the specific levels described for each individual element of the building systems. Envelope optimization using this method shall be carried out in accordance with Annex B.
- b) *Trade-off method* – This is a systems-based approach, where the thermal performance of individual envelope components can be reduced, if compensated by higher efficiency in other building components (for example, using higher wall insulation could allow for a less stringent *U*-value requirement for windows, or *vice-versa*). These trade-offs typically occur within major building systems – roofs, walls, fenestrations, overhangs, etc. This method offers the designer more flexibility than strictly following the prescribed values for individual elements. The thermal performance of one envelope component such as the roof can fail to meet the prescriptive requirements as long as other components perform better than what is required to make necessary compensation. Trade-offs are permitted only between building envelope components. It is not permitted, for instance, to make trade-offs against improvements in the lighting or HVAC systems. However, this method makes using the envelope trade-off option more complicated than the prescriptive method. It is necessary to calculate the surface area of each exterior and semi-exterior surface; all areas are required to be calculated separately for each orientation. Envelope optimization using this method shall be carried out in accordance with Annex C.

- c) *Whole building analysis method* – This method models the thermal, lighting, ventilation occupancy, and other energy-consuming processes taking place within the building to simulate and predict its energy performance. The simulation programme takes into account the building geometry and orientation, building materials, building facade design and characteristics, climate, indoor environmental conditions, occupant activities and schedules, HVAC and lighting system and other parameters to analyse and predict the energy performance of the building. This may be done using computer simulation models, which can be accomplished with a variety of proven software tools and in many cases may be the best method for guiding a building project to be energy-efficient. However, this approach does require considerable knowledge of building physics and building simulation tools and very close communication between members of the design team. Envelope optimization using this method shall be carried out in accordance with Annex D.

### **8.3 Renewable Energy Integration in Envelope**

#### **8.3.1 *Integration of Solar Thermal Technologies***

Solar collectors that harness the solar energy directly into usable heat can be aesthetically integrated with the building envelope or they may be mounted on the roof of building.

#### **8.3.2 *Integration of Photovoltaic Technologies***

Building integrated photovoltaic (BIPV) system is the integration of photovoltaic (PV) and the building envelope. The PV modules can be designed and installed to serve the double purpose of both power generation and that of the building skin replacing conventional building envelope materials. By avoiding the cost of conventional materials, the incremental cost of photovoltaic is reduced and its life cycle cost is lower. A complete BIPV system includes the following:

- a) PV modules (which may be thin-film poly or mono crystalline, amorphous with transparent, semi-transparent, or opaque backing);
- b) Charge controller, to regulate the power into and out of the battery storage bank (in stand-alone systems);
- c) Power storage system, generally comprising utility grid in utility-interactive systems or, a number of batteries in stand-alone systems;
- d) Power conversion equipment including an inverter to convert the d.c. output of PV modules to a.c. compatible with the utility grid;
- e) Backup power supplies such as diesel generators (optional), typically employed in stand-alone systems; and
- f) Appropriate support and mounting hardware, wiring, and safety disconnects.

While photovoltaic panels as in (a) are considered as PV array, other components given in (b) to (f) are usually referred to as the balance of system (BoS). Not only solar



photovoltaic technologies but other ways of producing renewable energy may also be integrated in to design, depending upon suitability to geo-morphological conditions, geo-thermal pumps, wind, etc.

## **9 MATERIALS**

### **9.1 General**

Building materials choices are important in sustainable design because of the extensive network of activities such as extraction, processing and transportation steps required for making a material, and activities involved thereafter till building construction and even thereafter. These activities may pollute the air, soil and water, as well as destroy natural habitats and deplete natural resources.

One of the most effective strategies for minimizing the environmental impacts of material usage is to reuse existing buildings. Rehabilitation of existing building, their shell and non-shell components, not only reduces the volume of solid waste generated and its subsequent diversion to landfills but also the environmental impacts associated with the production, delivery and use or installation of new building materials.

The use of rapidly renewable materials, recycled materials minimizes the adverse impact of natural resource consumption in the manufacture of new building materials. The use of local materials supports the local economy and reduces the negative impact of transportation.

#### **9.1.1 *Environmental Concerns and Human Health and Safety Aspects Related to Building Materials***

Increased demand for building materials creates a major and diversified impact on the environment. Excessive extraction of raw material diminishes non-renewable natural resources very rapidly. Even during some extraction process, waste is generated whose disposal may pose problems. Sometimes extraction processes may also affect the wildlife. Transportation of building materials from one place to another is also a major indirect factor leading to harmful effects. During manufacturing or processing of some materials like plastic, harmful gases are generated, which are dangerous for human health and environment. There are many frequently used building materials like reconstituted wood products, paints, glues, carpet and upholstery, which may release gases, fumes, etc, from the chemical components used, even long after the installation. These volatile organic compounds (VOCs) affect the environment and human health and may cause headaches, dizziness, respiratory problems and even major diseases in human and other living beings.

##### **9.1.1.1 *Environmental Impact Categories***

Impact category is a class representing environmental issues of concern to which life cycle inventory analysis results should be assigned. Impact categories are specific environmental issues or effects that are considered in life cycle assessment (LCA) and

other environmental impact assessments. They help in evaluating and comparing the potential environmental impacts of products, processes, or systems.

These emissions come in different shapes and formats since the emissions from harvesting raw materials are very different from the emissions from producing electricity.

An impact category groups different emissions into one effect on the environment. For example, the impact category 'climate change' is expressed in kg CO<sub>2</sub> equivalents (kg CO<sub>2</sub>-eq). However, other greenhouse gas emissions than carbon emissions (CO<sub>2</sub>) also cause climate change, such as methane (CH<sub>4</sub>), or laughing gas (N<sub>2</sub>O). By expressing these other GHG emissions with different measuring units in kg CO<sub>2</sub> equivalents, an impact category makes it possible to come to a single metric for climate change.

In the context of building materials, understanding these impact categories is crucial for selecting materials that minimize environmental harm.

Some of the core environmental impact categories considered for assessing product environmental impact are given below

- a) Global Warming Potential (GWP)
- b) Ozone Depleting Potential (ODP)
- c) Eutrophication Potential (EP)
- d) Acidification Potential (AP)
- e) Photochemical oxidant creation potential (POCP)

#### **9.1.1.1.1 Global warming potential (GWP)**

Global Warming potential is the indicator for climate change measured in kgCO<sub>2</sub> eq. The global warming potential (GWP) is defined as an index measuring the radiative forcing following an emission of a unit mass of a given substance, accumulated over a chosen time horizon, relative to that of the reference substance, carbon dioxide (CO<sub>2</sub>).

#### **9.1.1.1.2 Ozone depletion**

Ozone Depleting Potential (ODP) is a metric used to quantify the relative ability of a substance to destroy the stratospheric ozone layer compared to a reference substance, usually chlorofluorocarbon-11 (CFC-11). The ODP of a chemical is determined by its effectiveness in catalysing the breakdown of ozone molecules in the stratosphere, where the ozone layer protects life on Earth by absorbing harmful ultraviolet (UV) radiation from the sun.

#### **9.1.1.1.3 Eutrophication potential (EP)**

Eutrophication potential (EP) is defined as the potential to cause over-fertilization of water and soil, which can result in increased growth of biomass. The overabundance of algae and plants caused by eutrophication sets off a chain reaction in the ecosystem, the excess

algae and plant matter eventually decompose, producing large amounts of carbon dioxide.

#### **9.1.1.1.4 Acidification potential (AP)**

Acidification potential (AP) refers to the measure of a substance's ability to contribute to the acidification of the environment, particularly the soil and water bodies. Acidification occurs when acidic pollutants are deposited onto the earth's surface, leading to a decrease in pH levels in soils and water bodies, which can harm ecosystems, affect biodiversity, and damage infrastructure.

#### **9.1.1.1.5 Photochemical oxidants creation potential (POCP)**

Photochemical oxidants creation potential (POCP), or photochemical smog, is usually expressed relative to the POCP classification factors of ethylene. The photochemical ozone creation potential (POCP) scale quantifies the relative abilities of volatile organic compounds (VOCs) to produce ground level ozone. Ozone can be formed when chemical reactions between oxides of nitrogen (NOX ) and volatile organic compounds (VOC), also known as hydrocarbons are caused either near the ground or in the atmosphere by heat and sunlight.

### **9.1.2 Minimizing Green House Gas (GHG) Emission**

Construction sector in the country is a major consumer of energy resulting in the largest share of CO<sub>2</sub> emissions in the atmosphere. Cement, steel and bricks, the largest and bulk consumption items in the construction industry, are contributors of large CO<sub>2</sub> emissions. It is estimated that close to a tonne of CO<sub>2</sub> is emitted during the production of every tonne of cement, resulting in very high GHG emission. Similarly, bricks and concrete, which are very widely used construction material have very high GHG emission. Minimizing the consumption of such conventional materials which may contribute to substantial GHG emission, by using alternative materials and alternative methods and techniques can considerably reduce energy and CO<sub>2</sub> emissions.

#### **9.1.2.1 Introduction to Embodied Carbon**

**Embodied Energy** - The embodied energy refers to the total energy used to produce the materials that make up the building. It includes the energy used in mining, manufacturing and transporting the materials, as well as the services in the economy that support these processes. Embodied energy is expressed in MJ/kg.

**Embodied Carbon** - Embodied Carbon refers to the total amount of carbon dioxide (CO<sub>2</sub>) and other greenhouse gasses (GHGs) emitted during the entire life cycle of a product, building, or material. This includes all emissions associated with the extraction of raw materials, manufacturing, transportation, construction, maintenance, and eventual disposal or recycling of the product. Embodied Carbon is expressed in kgCO<sub>2</sub>e.

Embodied Carbon in Buildings - Addressing climate change has traditionally focused on reducing carbon emissions from operational energy consumption. However, as buildings become more energy efficient and electricity generation decarbonizes, the operational carbon of new buildings will significantly reduce. This means that embodied carbon will represent a higher proportion of whole life carbon (WLC) than it used to. Thus, embodied carbon will become significant and can represent 40-70 percent of whole life carbon in a new low carbon building.

### **9.1.2.2 Embodied Carbon Benchmarks and standards for Buildings**

Embodied carbon benchmarks provide targets or reference values for the acceptable levels of embodied carbon in building projects. They help to measure and compare the environmental impact of their projects. A number of organizations including professional bodies, advisory groups and governments, have introduced benchmarks & aspirational targets to achieve a common goal in terms of climate change. The embodied carbon emissions of buildings are normalized over the built up area. Though there is a lack of consistency across various benchmarks in terms of the system boundary and scope, these are required in supporting a transition from typical to good and then best practice.

### **9.1.2.3 *Optimizing embodied carbon in buildings***

#### **9.1.2.3.1 *Design Optimization***

Re-use or retrofit existing buildings instead of constructing a completely new building. Reductions in new square footage or new structure will translate directly to reductions in embodied carbon. By prioritizing efficient use of space, renovation, and revitalization, we can create sustainable and liveable communities with a significantly lower carbon footprint. Explore design approaches that allow for flexibility to limit the creation of additional floor space. Just as reusing materials and buildings conserves resources, minimizing new floor area leads to savings in materials and costs while also reducing embodied carbon.

#### **9.1.2.3.2 *Structural Design Optimization***

Review and design structural loadings, utilization and spans and dead loads. Choosing lighter materials and assemblies for structural and envelope systems can reduce the load on structural components, thereby decreasing their size and embodied carbon. Using void systems to lighten slabs or opting for materials like timber can also enable the preservation of existing structures, leading to further carbon savings through building reuse.

Explore structural design technologies to reduce quantity (precast vs cast in situ) and optimize grid sizing using less of a material to do the same work results in large carbon and cost savings. Structural design choices such as bay sizing, column and beam spacing, and member cross sections, as well as avoiding structural gymnastics (like cantilevers and transfer beams) can all reduce carbon.

Explore the possible application of recycled materials in the design of stabilized structures. Minimizing portland cement and/or replacing portland cement with other supplementary cementitious materials (fly ash, slag, etc.) also reduces embodied carbon.

Reduce or eliminate below-grade parking or interior spaces. Subgrade construction requires a large amount of concrete (a carbon-intensive material) and releases soil carbon during excavation.

#### **9.1.2.3.3 Building Material Selection**

It is important to understand where carbon is, including major impact materials and materials that need multiple replacements during the building service life.

Specify low-carbon, renewable, bio based, re-used or recycled materials from responsible sources. Bio-based materials generally have lower upfront carbon than conventional options and can store carbon throughout a building's life. Alternatives like mass timber, bamboo, wood fibreboard, hempcrete, and cork are becoming more available. These materials are often lighter, reducing the load on structural components and further lowering carbon emissions.

Material selection criterion:

- a) Material with highest possible recycled content
- b) Locally sourced materials
- c) Bio- based materials
- d) Natural/carbon sequestering alternative
- e) Bamboo based/rapidly renewable materials
- f) Materials with environmental disclosures or established EPD
- g) Low environmental Impact & resource efficient materials
- h) Responsibly sourced materials\*

\*Responsible sourcing is the incorporation of ethical, sustainable and socially conscious principles into sourcing, procurement and overall supply chain management practices.

#### **9.1.2.3.4 Design for Circularity**

Design building components with connections that allow for easy disassembly and reuse in future projects. Avoid using lamination or adhesives in assemblies that hinder deconstruction, and steer clear of materials and coatings that complicate recycling. Mechanically fix systems rather than adhesive fix so they can be demounted and re-used or recycled.

Reuse materials, such as those onsite or from other properties or purchase salvaged materials rather than new ones. Consider refurbishing items, such as furniture, instead of throwing them out and re-purchasing them.

Minimize construction and demolition waste (waste prevention)

Design for durability, flexibility and adaptability. Review material efficiency options like designing to standard building sizes or for a repeating module.

### 9.1.3 Building Material

An ideal sustainable building material is not only environment friendly, causes no adverse impact on health of occupants, is readily available, can be reclaimed, can be recycled and is made from renewable raw material, but also uses predominantly renewable energy in its extraction, production, transportation, fixing and ultimate disposal. Practically, this kind of ideal material may not be available, hence when selecting sustainable materials, it may be best to choose materials which fulfill most of these criteria.

### 9.1.4 Life Cycle Assessment (LCA) of Building Materials

LCA of building materials intends to assess the potential environmental impacts at every stage in the life cycle of a material (see Fig. 24) right from the raw material sourcing, processing, manufacturing and finishing, up to the product installation, maintenance and ultimately reuse/recycle/demolition. It is a tool to determine the environmental suitability of any building material for a thorough understanding of the environmental impact and the improvement which can be employed at every stage of a material, so as to make a decision for its selection after evaluation of criteria such as embodied energy, performance and durability.

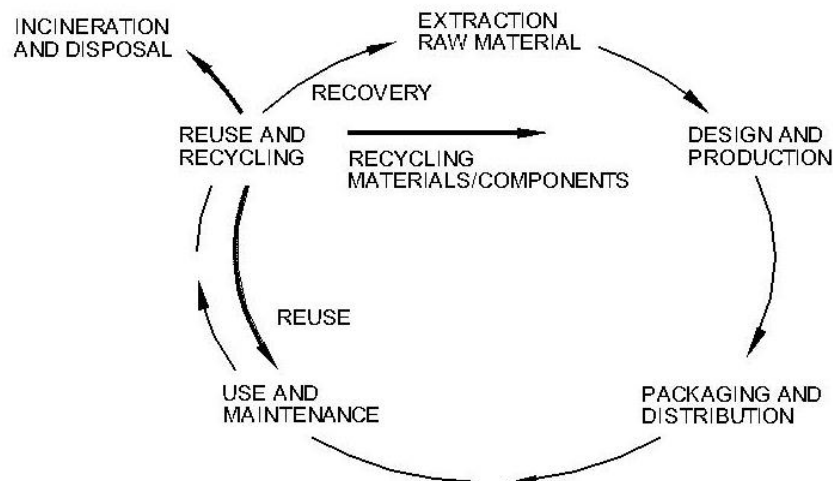

FIG. 24 LIFE CYCLE OF BUILDING MATERIAL

A description of life cycle analysis with respect to various relevant criteria is given below:

- a) *Embodied energy* – It is an important factor to be considered in the life cycle assessment of a material. Minimizing embodied energy means minimizing the

impact on the environment. In any building construction use of materials with low embodied energy should be considered.

Table 13 gives classification of building materials based on their energy intensity and gives the comparative embodied energy for a few building materials.

**Table 13 Classification of Materials Based on Energy Intensity**

[Clause 9.1.4 (a)]

Sl No.	Category of Material	Energy Intensity (Range) GJ/t	Examples
(1)	(2)	(3)	(4)
i)	Very high energy	>50	Aluminium, stainless steel, plastic, copper, zinc
ii)	High energy	5 - 50	Cement, steel, glass, bitumen, solvents, cardboard, paper and lead
iii)	Medium energy	1 - 5	Lime, gypsum plaster board, burnt clay brick, burnt clay brick from improved vertical shaft kiln, aerated block, hollow concrete block, gypsum plaster, concrete block, timber, wood products, particle board, medium density fibre board, cellulose insulation, <i>in-situ concrete</i>
iv)	Low energy	<1	Sand, aggregate, fly ash and fly ash based products, cement stabilized soil block, straw bale, bamboo, stone

NOTES

- 1 While comparing embodied energy of building materials, the total quantity by mass of the material times the embodied energy value per unit mass (energy intensity) of the material to be installed for same surface area of the building may be compared.
- 2 The values given in the table are comparative values, and in case of substantial difference in the transportation component of the materials in question, the same should also be taken into account while calculating the embodied energy.

- b) *Resource reuse and upgradation* – It includes saving a material from disposal and utilizing it by renovating, repairing, restoring, or generally improving the appearance, performance, quality, functionality, or value of a product. Efforts should be made to reuse existing, previously occupied buildings – including the structure, envelope and elements, after removing or replacing the elements which

have risk of failure/contamination during construction or occupancy. Upgradation of systems should be done in the areas of energy and water efficiency where the previously installed systems are not environment friendly or efficient.

- c) *Recycled content* – To reduce the demand for virgin materials, effort should be made to use the products with identifiable recycled content, including from those coming from industrial and post-consumer utilization, with a preference for the later.
- d) *Reusable or recyclable* – Effort should be made to select materials that can be easily dismantled and reused or recycled at the end of their useful life. Consider installation techniques which allow easy dismantling and reuse of materials.
- e) *Natural, plentiful* – Effort should be made to use materials which are bio-based and naturally harvested from sustainably managed sources.
- f) *Bio-degradable* – Consider using materials which are bio-degradable so that they can be harmlessly disposed at the end of their life cycle.
- g) *Indigenous or locally available* – Effort should be made to use building materials, components, and systems which are found locally or regionally, saving energy and resources for transportation of materials to the project site.
- h) *Rapidly renewable material* – Effort should be made to use materials which replenish substantially faster than traditional extraction demand (for example, timber which can be planted and harvested in less than a 10 year cycle) to reduce the demand for limited/finite resources.
- j) *Materials compliant with clean air and clean water* – Effort should be made to select those materials that emit few or no carcinogens, reproductive toxicants, VOCs, etc. Such materials that enhance the indoor environment quality and consume less water, do not cause water contamination, pollution as well as help in reducing water consumption should be considered for use.
- k) *Materials having low ozone depletion potential* – Efforts should be made to select materials which do not use in their manufacture, chemicals that have an ozone depleting potential (ODP).

#### **9.1.4.1 Life Cycle Stages**

The life cycle of a construction product and a construction works is divided into four life cycle stages, which include a number of information modules (see figure 25). These life cycle stages describe the entire product system of any construction product and the corresponding LCA results are reported according to these life cycle stages in an EPD.



Life cycle Stages and their information modules for construction products and construction works

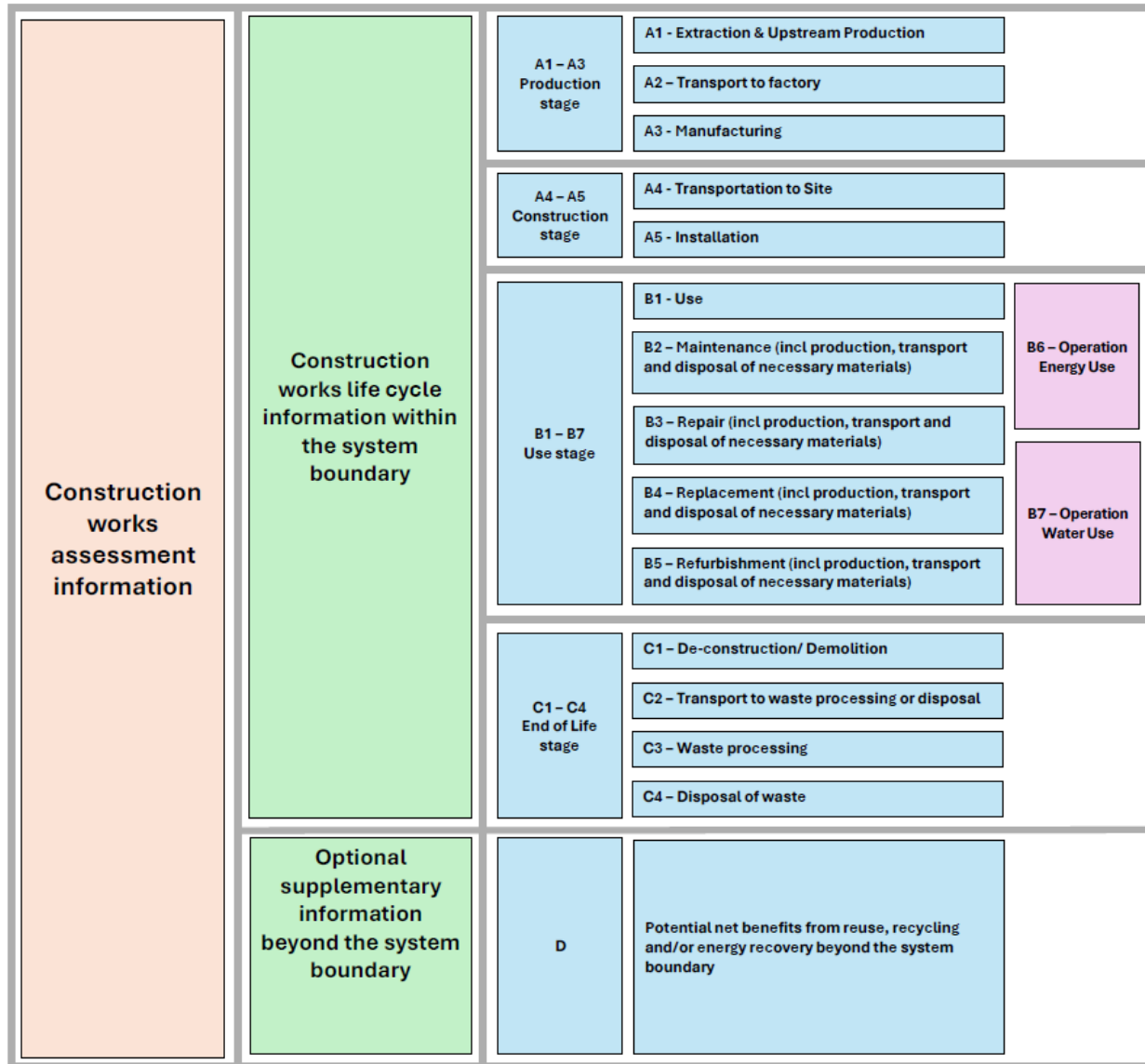

**FIG. 25 LIFE CYCLE STAGES AND THEIR INFORMATION MODULES FOR CONSTRUCTION PRODUCTS AND CONSTRUCTION WORKS**

a) Cradle to gate - Covers the mandatory production stage that includes the following information modules:

Extraction and upstream production (raw material supply), transport to factory and manufacturing. The LCA results shall be reported based on a declared unit.

b) Cradle to grave - Covers the mandatory production stage (A1 to A3) and all of the information modules from the construction stage (A4 to A5), use stage (B1 to B7), and end-of-life stage (C1 to C4).

c) Cradle to Cradle - Cradle-to-cradle is a concept often referred to within the Circular Economy. It is a variation of cradle-to-grave, exchanging the waste stage with a recycling process that makes it reusable for another product, essentially “closing the loop”. This is why it is also referred to as closed-loop recycling.

It covers the mandatory production stage (A1 to A3) and all of the information modules from the construction stage (A4 to A5), use stage (B1 to B7), and end-of-life stage (C1 to C4) and additional module D.

#### **9.1.4.1.1 A1 to A3, Production stage**

The production stage includes the following three information modules A1 to A3

- a) A1, extraction and upstream production;
- b) A2, transport to factory;
- c) A3, manufacturing.

##### **9.1.4.1.1.1 A1, extraction and upstream production**

The information module “extraction and upstream production” covers raw material extraction and processing, processing of secondary material input (for example, recycling processes).

- a) A1 extraction and processing of raw materials (e.g. mining processes) and biomass production and processing (e.g. agricultural or forestry operations), including the production of inputs where they are used;
- b) A1, reuse of products or materials from a previous product system;
- c) A1, processing of secondary materials used as input for manufacturing the product, but not including those processes that are part of the waste processing in the previous product system;
- d) A1, generation of electricity, steam and heat from primary energy resources used for extraction and processing of raw materials, including their extraction, refining and transport;
- e) A1, generation of electricity, steam and heat from secondary fuels, but not including those processes that are part of waste processing in the previous product system to recover secondary fuels;
- f) A1, energy recovery and other recovery processes from secondary fuels, but not including those processes that are part of waste processing in the previous product system;
- g) A1, waste management from manufacturing packaging and manufacturing wastage including transport up to the recycler or disposal.

**9.1.4.1.1.2 A2, Transport to factory**

The information module “transport to factory” covers transport of raw materials and other inputs to the factory and internal transport.

**9.1.4.1.1.3 A3, Manufacturing**

The information module “manufacturing” includes

- a) A3, production of ancillary materials or pre-products;
- b) A3, generation of electricity, steam and heat from primary energy resources used in manufacturing, including their extraction, refining and transport;
- c) A3, energy recovery and other recovery processes from secondary fuels, but not including those processes that are part of waste processing in the previous product system;
- d) A3, emissions from the combustion of secondary fuels and waste used in the manufacturing process;
- e) A3, manufacturing of products and co-products, including their extraction, manufacturing and transport;
- f) A3, manufacturing of packaging, including their extraction, manufacturing and transport;
- g) A3, waste management from manufacturing packaging and manufacturing wastage including transport up to the recycler or disposal.

**9.1.4.1.2 A4 to A5, construction stage**

The construction stage includes the following two information modules A4 to A5

- a) A4, transport to site;
- b) A5, installation.

**9.1.4.1.2.1 A4, transport to site**

The information module “transport to site” includes

- a) A4, transportation from the factory gate to the central warehouse or intermediate storage site, if relevant;
- b) A4, transportation to the construction site.

Transport distance should be as specific as possible. The distance to the construction site may be estimated based on weighted average distance to the market of the product.

**9.1.4.1.2.2 A5, installation**

The information module “installation” covers installation of the construction product into any type of construction works. This includes

- a) A5, wastage of construction products including the production processes (A1 to A3) and transport to site (A4) to account for the material lost from wastage of products;
- b) A5, waste processing of the waste from product packaging and product wastage including transport during the construction processes up to the system boundary between product systems or disposal of final residues;
- c) A5, installation of the product into the construction works including manufacture and transportation of ancillary materials and any direct use of energy or consumption of freshwater required for installation at the construction site;
- d) A5, installation specific site preparation for the declared product including ancillary materials and waste management if relevant.

#### **9.1.4.1.3 B1 to B5, use stage**

The use stage of the construction works includes the following five information modules

- a) B1, use or application of the installed product;
- b) B2, maintenance;
- c) B3, repair;
- d) B4, replacement;
- e) B5, refurbishment

##### **9.1.4.1.3.1 B1, Use or application of the installed product**

The information module “use or application of the installed product” covers environmental aspects and impacts connected to the normal (i.e. anticipated) use of products, not including those related to energy and water use, which are dealt with in B6 and B7, for example release of substances from the facade, roof, floor covering, walls and different surfaces (interior or exterior).

##### **9.1.4.1.3.2 B2, Maintenance**

The information module “maintenance” covers the combination of all planned technical actions during the reference service life to maintain the construction product installed in a construction works or its parts in a state in which it can perform its required functional and technical performance, as well as preserve the aesthetic qualities of the product. This includes

- a) B2, preventative and regular maintenance activity such as cleaning and the planned servicing, replacement of replaceable components or repair of worn, damaged or degraded parts;

- b) B2, production (A1 to A3) of any component and ancillary products used for maintenance, for example cleaning agents;
- c) B2, transportation (A4) of any component and ancillary products used for maintenance;
- d) B2, use of related energy and water, including generation and distribution; B2, transportation of any waste from maintenance processes or from maintenance related transportation;
- e) B2, end-of-life processes of any waste including transportation and the maintenance process, including any part of the component and ancillary materials removed.
- f) B2, Water and energy usage (including production and distribution) required for cleaning, as part of maintenance shall be included in this module

#### **9.1.4.1.3.3 B3, repair**

The module 'repair' covers a combination of all technical actions during the service life associated with corrective, responsive or reactive treatment of a construction product or its parts installed in the construction works to return it to an acceptable condition in which it can perform its required functional and technical performance. It also covers the preservation of the aesthetic qualities of the product. At the product level, replacement of a broken component or part due to damage should be assigned to 'repair', whereas replacement of a whole element due to damage should be assigned to the module 'replacement' at the construction works level. This includes:

- a) B3, repair process of the repaired part of a component;
- b) B3, production (A1 to A3) of any component and ancillary products used for the repair;
- c) B3, transportation (A4) of any component and ancillary products used for the repair;
- d) B3, use of related energy and water; including generation and distribution;
- e) B3, transportation of any waste from repair processes or from repair related transportation;
- f) B3, end-of-life processes of any waste from transportation and the repair process, including any part of the component and ancillary materials removed

#### **9.1.4.1.3.4 B4, Replacement**

The information module 'replacement' covers the combination of all technical actions during the service life of the construction works associated with the return of the construction works to a condition in which it can perform its original required functional or technical performance by replacement of the construction product or construction element.

At the product level, 'replacement' of a broken component or part due to damage should be assigned to 'maintenance' (B2) or 'repair' (B3), whereas replacement of a whole

construction product or construction element due to damage should be assigned to 'replacement' at the construction works level. This includes

- a) B4, production (A1 to A3) of any component and ancillary products used for replacement;
- b) B4, transportation (A4) of any component and ancillary products used for replacement;
- c) B4, use of related energy and water, including generation and distribution;
- d) B4, transportation of any waste from replacement processes or from replacement-related transportation;
- e) B4, end of life processes of any waste from transportation and the replacement process, including any part of the component and ancillary materials removed.

#### **9.1.4.1.3.5 B5, refurbishment**

The information module 'refurbishment' covers the combination of all technical actions during the service life of a product associated with the return of construction works or their parts to a condition in which it can perform its required functions. Restoration activities should be included within refurbishment. This includes

- a) B5, production (A1 to A3) of any component and ancillary product used for refurbishment;
- b) B5, transportation (A4) of the component and ancillary materials used for refurbishment, including production aspects and impacts of any losses during transportation;
- c) B5, use of related energy and water, including generation and distribution;
- d) B5, transportation of any waste from refurbishment processes or from refurbishment-related transportation;
- e) B5, end-of-life processes of any losses suffered during transportation and the refurbishment process, including the components and ancillary materials removed.

#### **9.1.4.1.4 B6 to B7, use stage, information modules related to the operation of the construction works**

The use stage related to the operation of the construction works includes the following two information modules

- a) B6, operational energy;
- b) B7, operational water use.

**9.1.4.1.4.1 B6, operational energy use**

The information module 'operational energy use' covers the operation of integrated technical systems (for example, operation of heating system and other construction works related installed services). Integrated technical systems are installed technical equipment that support operation of construction works.

This includes technical systems for heating, cooling, ventilation, lighting, domestic hot water and other systems for sanitation, security, fire safety, internal transport, building automation and control and IT communications.

This includes generation, distribution and use of energy during the operation of the product (the integrated technical system), together with its associated environmental aspects and impacts including processing and transportation of any waste arising on site from the use of energy.

**9.1.4.1.4.2 B7, operational water use**

The information module 'operational water use' covers water use by integrated technical systems during the period from the handover of the construction works to when it is deconstructed or demolished.

This includes water use during the operation of the product (the integrated technical system), together with its associated environmental aspects and impacts considering the life cycle of water including production and transportation and wastewater treatment

**9.1.4.1.5 C1 to C4, end-of-life stage**

The end-of-life stage of the construction product starts when it is replaced, dismantled or deconstructed from the construction works and does not provide any further functionality. The end-of-life stage includes the following four information modules C1 to C4

- a) C1, deconstruction/demolition, which includes dismantling or demolition, of the construction product from the construction works and the energy use for this, including initial on-site sorting of the materials;
- b) C2, transportation to waste processing or disposal, which includes the transportation of the discarded construction product as part of the waste processing, for example to a recycling site and transportation of waste, for example to final disposal;
- c) C3, waste processing, which includes, for example collection of waste fractions from the deconstruction, recovery and waste processing of material flows resulting in materials for reuse, secondary materials, secondary fuels or export of recovered energy from the energy recovery from waste with an efficiency of energy recovery of at least 60 percent, without prejudice to existing legislation;

- d) C4, disposal of waste which includes physical pre-treatment and management of the disposal site, including provision and transport of all materials, products and related energy and water use.

#### **9.1.4.1.6 Benefits and loads beyond the system boundary in optional supplementary module D**

Module D is not a life cycle stage like the life cycle stages assessed in information modules A1 to C4. Module D is outside the system boundary of the studied product system and construction works system. Module D is not an allocation approach and does not report impacts that are allocated to other product systems as a result of co-production or recovery processes. Module D provides optional supplementary information about the potential net benefits from reuse, recycling and energy recovery beyond the system boundary of the studied product system

#### **9.1.5 Whole Building Life Cycle Assessment Methodology**

Whole building LCA provides an assessment of the embodied carbon impact of a whole building. This includes the impact of all materials used in the project, or a subset of the project, like structure and/or envelope, throughout the life cycle of the building. Similar to energy modelling, architects, or their consultants, should perform whole building LCAs throughout the design process to actively inform the design of a building.

Standard methodology for the whole building life cycle assessment shall be as per good practice [11(35)].

This section outlines the four key steps of an LCA with guidance specific to performing a Whole Building LCA.

- a) Defining goal and scope,
- b) Life cycle inventory- Data collection,
- c) Impact assessment, and
- d) Result interpretation.

##### **9.1.5.1 Defining Goal and Scope**

Defining the goal of the assessment is important for determining why and how you conduct a Whole Building LCA.

It shall cover

- a) The intended application,
- b) The reasons for carrying out the study,
- c) The intended audience, i.e. to whom the results of the study are intended to be communicated, and



- d) Whether the results are intended to be used in comparative assertions intended to be disclosed to the public.

#### 9.1.5.1.1 *Scope of study*

This section defines the functional requirements and system boundaries of the study. The system boundary describes the functional description, reference unit, reference study period.

##### 9.1.5.1.1.1 *Physical Scope*

The functional use shall include the following information

Project use type (e.g., commercial, residential, school, etc.) and form (e.g., low-, mid-, or high-rise).

- a) Technical requirements - These are likely defined by the building code and other standards and rating systems.
- b) Functional requirements - These are likely defined by the owner's project requirements, such as the number of residential units or minimum programmatic needs.
- c) Pattern of use (e.g., expected number of occupants); and
- d) Reference service life (e.g., expected life span of the building).

##### 9.1.5.1.2 *Reference Units*

- a) **Material carbon emission factor (kgco2e/ functional unit)** - Embodied carbon is typically measured in kilograms of carbon dioxide equivalent (kg CO<sub>2</sub>e) per unit of material or product. Environmental product declarations (EPDs) declare the emissions in a default functional unit which varies from material to material. This means that the carbon footprint of a material is expressed as the amount of carbon dioxide that would have the same global warming potential as the total greenhouse gas emissions associated with the material's entire lifecycle.
- b) **Building carbon emission factor for (kgco2e/sqm)** - The building carbon footprint is reported in kilograms of carbon dioxide equivalent (kg CO<sub>2</sub>e) per unit area. The unit of measurement for floor area considered is gross internal area (GIA).

This allows for comparison of buildings of different shapes and sizes, facilitates tracking emissions across a project or between different projects, and is compatible with other types of building performance accounting.

##### 9.1.5.1.3 *Reference study period*

The reference study period defines the temporal boundary of the LCA, typically measured in years. This has a large impact on the results of the LCA because it affects the

magnitude of impacts from maintenance and replacement of materials, particularly for interior components.

#### 9.1.5.1.4 System boundary

The system boundary describes the physical scope, life cycle scope, and impacts to be evaluated.

The physical scope of a Whole Building LCA refers to the building elements or element categories under study such as structure, envelope, interiors, and mechanical, electrical, and plumbing etc (see Fig. 26).

Physical Scope			
Level 1	Element Group	Level 2	Element Group
1	Substructure	1.1	Substructure
2	Superstructure	2.1	Frame
		2.2	Upper floors
		2.3	Roofs
		2.4	Stairs and ramps
2	Façade	2.5	External walls
		2.6	Windows and external doors
2	Internal walls and partitions	2.7	Internal walls and partitions
		2.8	Internal doors
3	Internal finishes	3.1	Wall finishes
		3.2	Floor finishes
		3.3	Ceiling finishes
4	FF&E	4.1	Fittings, furnishings and equipment
5	Building services	5.1	Building services

**FIG. 26 PHYSICAL SCOPE**

The life cycle scope defines which life cycle assessment stages are included.

For embodied carbon, best practice is to include (at a minimum) stages A1-A5, B2-B4, and C1-C4.

#### 9.1.5.2 Life cycle inventory – data collection

The qualitative and quantitative data for inclusion in the inventory shall be collected for each unit process that is included within the system boundary. The collected data,

whether measured, calculated or estimated, are utilized to quantify the inputs and outputs of a unit process.

The Life Cycle Inventory involves the extraction of the following relevant material data

- a) Types and quantities of materials that are part of the physical scope defined in the previous step. Quantities can be extracted from bill of quantities.
- b) Environmental impact factors of materials. Impact factors such as carbon emission factors for materials can be derived from various LCI databases, EPDs, product manufacturer declaration, LCA tools etc.
- c) Additional information such as transportation scenarios & emissions, material replacement frequencies (service life).

Refer to good practice [11(36)] for a detailed description of this stage.

#### **9.1.5.3 *Life cycle impact assessment***

Material quantities are multiplied by environmental impact factors for each respective material and the results are summed up for the whole building. LCA tools can be used for computing the environmental impacts.

Refer to good practice [11(36)] for a detailed description of this stage.

#### **9.1.5.4 *Interpret results***

This step focuses on interpreting the results through a 'hot-spot analysis', which identifies significant contributors to environmental impacts by breaking them down by building component, material type, and life cycle stage. Errors should be checked by comparing results to similar LCA studies and reality-checking high-impact items. Benchmarking against studies with the same system boundaries can also help validate results. Further understanding can be gained through sensitivity and uncertainty analyses. Multiple assessments can be made to compare the impacts of different materials and construction methods. This step is key in assessing if the goals are met or not.

#### **9.1.6 *LCA Tools***

There are a number of available tools that help automate the LCA and generate environmental impact results (for embodied and whole life carbon and for various life cycle stages). The accuracy of LCA calculations and reporting is influenced by the tool itself and the use of data sources. The use of credible tools and reliable data sources is not only essential when considering routes to regulating embodied carbon, it is also vitally important for ensuring accuracy of assessment and to confidently make the right choices to mitigate embodied carbon impacts.

#### **9.1.7 *Environmental Declaration & Disclosures***

Environmental declaration is a claim which indicates the environmental aspects of a product or service.

Environmental disclosures like Environmental product declarations (EPDs), product life cycle assessment reports, sustainable product certifications provide information on the environmental impacts of a product during all or some phases of its lifecycle.

#### **9.1.7.1 Environmental product declaration (EPD)**

An environmental product declaration (EPD) is a transparent report that quantifies the environmental impact of a product throughout its entire life cycle. This document helps inform stakeholders about the environmental footprint of a product and allows for comparisons between similar products.

EPDs are based on product LCAs that cover, at a minimum, the impacts of product extraction, transportation, and manufacturing (stages A1-A3). EPDs are therefore well-suited to capture manufacturing and supply chain strategies that prioritize material and energy efficiency, and low-carbon energy sources. EPDs are third party verified and governed by product category rules (PCRs). A PCR is a set of rules and guidelines for a particular product or group of products. A PCR dictates how the practitioner should perform the LCA for an EPD of that product category.

## **9.2 Materials and Recommended Sustainable Alternatives**

For quality requirements of building materials reference shall be made to National Building Code of India: Part 5 'Building Materials' of the Code. General guidelines and considerations for use of different structural and surface finishing materials and with alternatives for helping in sustainable construction, are given under **9.2.1** and **9.2.2**.

### **9.2.1 Structural Materials**

#### **9.2.1.1 Cement concrete**

Concrete is a strong, durable material and provides good thermal mass to buildings. However, manufacture of cement used in it is a high energy-intensive process and source of pollution, requiring also high energy for its transportation due to centralized production. Extraction and mining of aggregates also result in natural habitat destruction or deforestations. Following are the recommended alternatives to conventional concrete:

- a) *Use of pozzolanas and other mineral admixtures for cement replacement in cement concrete and other cement matrix products:*
  - 1) *Use of fly ash and slag in cement concrete* –Pozzolanas like fly ash or ground slag may be used to replace certain percentage of ordinary Portland cement in cement concrete in accordance with the good practice [11(3)] or

cement manufactured by using mineral admixtures like fly ash or ground slag may be used, in accordance with the good practice [11(3)].

- 2) *Rice husk ash (RHA)* – Rice husk ash, a waste from rice industry, is pozzolanic in nature and may be used for part replacement of cement in accordance with the good practice [11(3)].
  - 3) *Ready mixed concrete (RMC)* – RMC provides opportunity for use of pozzolanas and slag in greater quantities while maintaining strict quality control. Also, there are advantages of RMC over conventional concrete such as reduction noise and dust pollution, apart from better quality control. Preference may be given to use of RMC, if the RMC manufacturing plant is nearby. The manufacture, quality control delivery, etc of RMC shall be done in accordance with the good practice [11(4)].
  - 4) *Geopolymer concrete* – It is made with fly ash, ground granulated blast furnace slag (GGBS), fine aggregates and coarse aggregates and catalytic liquid system (CLS). This concrete uses no Portland cement and utilizes waste products. It has good resistance to chloride penetration and acid attack. However, geopolymer concrete is a future sustainable material option as it is in development stage. It could be designed and developed for a specific use in a project for which specialist literature may be referred.
  - 5) *Other cement concrete mix and products/cement matrix products/lime-pozzolana mixtures* – Various cement concrete mix and products, other cement matrix products, lime-pozzolana mixtures, etc, used in buildings having waste based/by-product mineral admixtures such as fly ash and slag may be produced or used. The requirements of such products and for their utilization shall be in accordance with accepted standards and good practice [11(5)] which also includes list of accepted standards for mineral admixtures for use in such products as may be applicable.
- b) *Use of recycled aggregate* – Crushed concrete aggregate is most common form of recycled aggregate which should be considered for use in concrete. The recycled concrete aggregate should be intended to offer the same level of strength and durability as conventional aggregate from natural resources. In the concrete mix, both virgin aggregate from natural resources and recycled aggregate may be mixed with hydrated cement paste. Such mix may have reduced specific gravity and increased porosity compared to concrete using similar virgin aggregate from natural sources. It is recommended that recycled aggregate be batched in a pre-wetted and close-to-saturated surface dry condition. Recycled aggregate may be used in concrete for bulk fills, bank protection, base/fills of drainage structures, pavements, sidewalks, kerbs and gutters, etc. Up to 30 percent of natural crushed coarse aggregates can be replaced by the coarse recycled concrete aggregate, in fresh concrete. This percentage can be increased up to 50 percent for pavements and other areas which are under pure compression. Also refer good practices [11(3)]. For quality requirements for other/artificial aggregates such as cinder as fine aggregate in lime, broken burnt clay bricks as coarse and fine aggregates, artificial light weight aggregates, etc, reference may be made to the accepted standards [11(6)].

- c) *Precast/prefabricated/partially prefabricated concrete elements* – Precast concrete can be used in construction in the form of building elements which are assembled at site and made monolithic by pouring *in-situ* concrete. The products are manufactured by casting concrete in a reusable mould or form which is then cured in a controlled environment, transported to the construction site, and erected at place. Precast concrete elements break the structural elements into smaller segments resulting in ease and economy in construction. Precast concrete roofing techniques like plank and joist roofing system, ferrocement roofing channels, precast arch panels, precast waffle units, L-panels are among roofing systems which may have comparatively less embodied energy than conventional RCC roof.
- d) *Use of light weight concrete:*
- 1) *Preformed foam concrete* – Preformed foam concrete may be considered for use for the levelling of floors, sprayed onto horizontal surfaces or in hollow cavities as light weight filler.
  - 2) *Ferrocement* – Ferrocement is a thin cement mortar laid over wire mesh (which acts as reinforcement). It uses minimal material (particularly steel) which is reduced compared to conventional RCC.
- e) *Use of light weight aggregates in concrete* – These are usually used in masonry blocks, slabs or floor beam units which are relatively strong. Light weight blocks help to reduce structural loading of building. These may be foamed blast furnace slag, bloated clay aggregate, sintered fly ash aggregate, cinder aggregate, etc. Mineral insulating aggregate in concrete like light expanded clay, pumice and expanded perlite have the lower moisture absorption coefficient, and are therefore best suited to products used for insulation. Fossil meal and exfoliated vermiculite, perlite or slag due to very high moisture absorption coefficient is preferred for high temperature equipment insulation. If artificial lightweight aggregate is used for making lightweight concrete, the same shall be in accordance with the accepted standard [11(7)].
- f) *Commonly used masonry concrete blocks:*
- 1) *Solid and hollow concrete blocks* – Hollow concrete block masonry uses lesser concrete as compared to solid concrete blocks and provides better thermal insulation due to cavity. Filling of the cores with concrete or concrete with steel reinforcement offers much greater tensile and lateral strength to structures, wherever required.
  - 2) *Autoclaved cellular (aerated) concrete blocks* – These are made by mixing fly-ash, lime, cement and gypsum, with foaming agent like aluminium powder which gives them the lightweight and good insulation property. These are lightweight blocks which can be useful to reduce dead load on structure, particularly of high rise buildings.

- 3) *Lightweight concrete blocks* – These blocks are lightweight and manufactured like normal concrete blocks using light weight aggregates.
- 4) *Preformed foam cellular concrete blocks* – These have considerably better thermal insulation properties than normal bricks or concrete.
- 5) *Concrete stone masonry blocks* – Precast concrete stone block masonry which uses recycled stone is a viable option. It can be made with waste stone pieces which could be locally available, and lean cement concrete.

The design mix of concrete blocks can also be done using fly ash as replacement of certain percentage of cement by volume. The concrete blocks shall be in accordance with the accepted standards [11(8)] and masonry construction using these blocks shall be in accordance with good practice [11(9)].

### 9.2.1.2 *Burnt clay bricks and tiles*

Bricks are made of clay which is abundant and generally sourced locally. They are durable and provide thermal mass to buildings. They are used for applications such as wall masonry, cladding, flooring and roof tiling. In many cases bricks can improve the indoor climate by regulating and stabilizing moisture levels.

Clay building waste being inert, its disposal has no detrimental effects on the environment. Exceptions are coloured and pigmented brick and ceramic tiles containing heavy metals, fire proof bricks containing soluble chrome and bricks from chimneys which have absorbed large amount of aromatic hydrocarbons during their life span. These products have to be separated and disposed of by following special precautions.

The burnt clay products have high durability, and these have high potential for their reuse as the energy needed to remove and clean up old material only represents approximately 0.5 percent of the energy required for the manufacture of new bricks and tiles. However, the recovery for reuse of bricks is facilitated, if a weak or medium-strength mortar has been used. Ceramic tiles or expanded clay pellets cannot be recycled and have to be usually more down-graded for uses such as for use as fill. Clay tiles and bricks can be broken up and used as fill, and aggregate in concrete in accordance with the good practice [11(3)].

Brick and clay manufacturing is a medium to high energy intensive and polluting process depending on the firing temperatures and type of kilns used in firing. Preference should be given to locally manufactured bricks and tiles to reduce transportation energy. The vertical shaft brick kiln technology which substantially reduces both the embodied energy and resultant emissions from brick production may be used. The consumption of energy in the kilns can be reduced considerably by the use of bricks with different firing temperatures, in different parts of the building.

The following other types of bricks may also be used as sustainable alternatives:

- 1) *Hollow/perforated bricks* – These types of bricks save the amount of material used and provide better thermal insulation due to the presence of air cavities. These bricks when provided with reinforcements can be used for structural applications and also in the form of filler blocks to replace concrete in the tensile zone.
- 2) *Low and medium-fired bricks* – Clay bricks which are burnt between 350 °C and 500 °C are low-fired bricks, and bricks burnt at slightly higher temperature like 500 °C to 800 °C are medium-fired bricks. Low-fired bricks are highly absorbent and hence recommended for use in internal walls or inner layer of external cavity walls (where they act as a moisture regulator), etc. The medium-fired bricks although comparatively more durable, may be used in similar applications as above.
- 3) *Burnt clay flyash bricks* – They are lower in embodied energy, provide better thermal property as compared to conventional burnt clay bricks and also utilize flyash, an industrial waste product.
- 4) *Flyash lime bricks* – These are flyash based and use bricks lime as the binder, along with accelerator in required proportion. These have good thermal properties. These are mostly used as masonry units and as fillers in pre-fabricated floor slabs.
- 5) *Red mud burnt bricks*– Red mud is a waste product from aluminium extraction industry. It contains mainly oxides of aluminium, iron and titanium. Red mud and flyash partly replace clay in these bricks. The alumina content gives a nice red tone to the brick. They have high compressive strength and are suitable for all types of construction. The presence of 4 to 5 percent of alkali in red mud also results in better plasticity and better bonding in these bricks.
- 6) *Lato bricks* – These are strong bricks (south western region of India) made of laterite soil mixed with cement or lime, and are moulded under pressure instead of being fired.

For quality requirements of bricks, reference shall be made to Part 5 'Building Materials' of the Code.

### **9.2.1.3 Traditional efficient building materials**

Each region in the country has developed unique ways of using locally available building material such as stone, timber, bamboo and soil. These building technologies have been developed over time, based on availability of natural materials, climatic considerations and culture. These techniques are not only environment friendly and energy efficient but are also cost effective as they involve the use of materials which are locally available reducing cost and energy on transportation.

#### **9.2.1.3.1 Earth construction**

Earthen buildings are easily recyclable, fire resistant, biodegradable, non-toxic, and have good thermal and sound absorption and moisture regulating properties. This type of construction can easily use onsite earth or locally available material depending on the quality of the earth available. Two main ways of making earthen buildings are ramming, where the earth is rammed between shuttering to make walls, and use of earth block (adobe), where the earth is first pressed into blocks and dried before use. Stabilizers



such as cement or lime may be added to improve durability. Straw and sawdust act as reinforcement as well as increase the insulation value. Well mixed, homogeneous earth construction has structural properties. Various options/considerations in this area are:

- a) *Adobe bricks* – These were made earlier with sand and clay mixed with a small proportion of water. Straw and/or grass are included as binder. Mixture is either poured into moulds or allowed to dry or it is pressed into blocks using hydraulic or lever press. Adobe can be made from wide range of soils but require plastering as they are not water-resistant. They have low structural strength but can be easily used for load bearing structures if, built between timber/concrete frames.

Stabilized adobe block construction is a new improved system of construction in which stabilization is done by adding fibres (plant or animal fibres), binders (cement, lime, pozzolanas, etc) and sometimes water proofing agents (bitumen, natural and synthetic resins). This kind of construction is suitable for areas with higher rainfall, condensation, flooding, etc. Proportion of soil content in stabilized adobe blocks may be: coarse sand 40-75 percent; clay 10-25 percent; silt 15-25 percent; and fine gravel 0-10 percent.

- b) *Adobe pouring construction* – In this system earth is compacted to an extent that the air gaps are eliminated, bulk density is considerably increased and the tendency of development of cracks and to absorb water is reduced. Adhesion of soil particles with one another increases the mechanical strength and improved water resistant, requiring no surface treatment. The ratio of wall thickness to the wall height should be between 1:8 and 1:12. Symmetrical and geometrical forms are preferred in use of this material.
- c) *Compressed earth blocks (CEB)* – In this type of construction, blocks are manufactured by compacting raw earth using stabilizer such as cement or lime. Compressed earth blocks are generally cuboidal in shape and can be made in solid, hollow or interlocked pattern. Thickness to height ratio of walls constructed with CEB should not be greater than 1:16 and wall thickness not less than 200 mm. This kind of construction can bear load up to three stories. The appropriate particle size distribution of the soil is a critical factor in using these blocks and soil analysis is specially recommended before considering CEB construction. Natural earth plasters with natural additives can also be used on unstabilized walls. These blocks have high compressive strength and provide good thermal mass. CO<sub>2</sub> emission is nil in the production of these blocks, if produced by manual operated compression machines and very low in case of other machines.
- d) *Soil based building blocks*– These blocks with appropriate combination of soil, cement, lime and possibly flyash (say 5 percent cement: 15 percent fly ash: 80 percent locally available soil) are cost effective and environmentally sustainable material. While in general building construction, soil based blocks may be used as a substitute for bricks, their use should be avoided in the case of isolated load

bearing columns, piers and such other heavily loaded structures. These may be made in accordance with the accepted standard [11(10)].

#### **9.2.1.3.2 Cob walls**

Cob walls are a traditional system of wall construction done with soil along with sufficient clay, rough sand, small stones, straw and water. Cob when formed as one mass is called monolithic adobe. Cob is suitable for construction wherever there is sufficient clay in soil/sand (preferably 30 percent). Dug out earth during construction can also be used for construction of cob walls. Unlike adobe brick buildings, cob walls do not require mortar joints, and therefore provide additional strength to the building. Plastering can be done in a 1:3 (lime: sand), for exterior and interior finishes.

Cob wall has good thermal mass properties, is fire resistant; can be integrated with other materials such as straw, light clay, timber frame, adobe, conventional wooden-framed structure; and can be easily moulded into any form.

#### **9.2.1.4 Stone**

Stone is a durable and abundant resource. It has much lower embodied energy as compared to brick and concrete as it is natural material and hence requires much less energy in processing. Stone is good in compressive strength but low in tensile strength. It is used as masonry, cladding, and flooring. Stone aggregates are used in concrete mixes. However, mining (quarrying) for stone may cause natural habitat destruction, deforestation and pollution.

Sustainable methodology should be the use of locally available (excavated) and undressed stone to the maximum possible extent subject to compliance to the environmental rules/regulations relating to its mining, etc.

For quality requirements of stones, reference shall be made to Part 5 'Building Materials' of the Code.

#### **9.2.1.5 Timber**

Timber is a building material which is used for structural as well as non-structural applications. It is a material with low embodied energy, is renewable, reusable, versatile, as well as varied in colour, pattern, grain, durability and strength. It is reusable and convertible into other sizes, and has a long life in indoor applications. Due to such properties of timber, its use may be desirable. However, over-harvesting of timber leads to adverse environmental effects such as natural habitat destruction, reduction in oxygen generation, soil erosion and silting of rivers. It is recommended to use timber harvested from sustainably managed forests or social/agro-forestry plantations or reclaimed (salvaged) timber. Secondary species of timber after proper treatment may be used for relevant applications. Timber should be properly seasoned and preservative treated. Timber is prone to fire, moisture ingress and termite and other insect attack. Therefore

appropriate treatment is required with least amount of toxic and chemical content, depending upon the end applications. The seasoning and treatment of timber shall be done in accordance with the good practices [11(11)]. For structural timber small dimensional timber from saw milling waste and forestry waste can be utilised for the design of built-up structural components.

Reconstituted wood products are high in embodied energy (due to manufacturing process involved) as well as have toxic formaldehyde contents. However, these products can be considered due to high waste utilization benefits. Prefer using such products that have lower formaldehyde emission.

Use of techniques, like finger jointing which enables utilization of smaller sized timber jointed together through this technique to yield desired larger pieces, may be employed.

For interior applications, use of reconstituted wood or other lignocellulosic panel products made from agricultural or industrial wastes (such as phospho-gypsum, bagasse, cotton stalk, rice-husk, coir fibre, pine needles, sisal fibre and wood residues) should be preferred. For partitioning, panelling, cladding, false-ceiling applications and flooring, the appropriate reconstituted wood or other panel products such as plywood, block boards, particle boards, fibre boards, etc, made from secondary species of wood or plantation timber or from other lignocellulosic ingredients may be used. Reference may be made to accepted standards [11(12)] for compliance and for criteria for making such products eligible to apply for Eco-Mark Certification in accordance with the provisions laid down in these standards.

#### **9.2.1.6 *Plastics***

Plastics are highly refined petroleum products. Plastics are materials with very high embodied energy, are non-biodegradable and may release harmful toxic gases during manufacturing processes or if burnt. Their disposal is a major problem yet, due to its light weight and flexibility, plastic has become a widely used material. It has various applications in the exteriors and interiors of buildings. The plastics are majorly used as insulation and as water proofing material [see **9.2.4.1.1(e)**]. UPVC (unplasticized polyvinyl chloride) window frames are also used for their light weight and thermal properties [see **9.2.3.2**]. The following recommendations may be considered from sustainability point of view:

- a) Use of plastics should be limited as far as possible or preference given to plastic products made with recycled content or renewable resources.
- b) Natural and renewable insulation materials should be preferred over plastic based insulation material.
- c) If required to be used for interiors, flooring, furniture and partitions products made with recyclable plastics should be preferred.

Other options where plastics may be used for appropriate applications, may be:

- 1) *Rice husk plastic wood*– It may be used in door and window frames, furniture and structural supports as it is moisture and termite resistant, highly workable, and meets the requirements of structural timber.
- 2) *Natural fibre composite panels and door shutters* – These are composites of natural fibres in laminate, faced on plastic wood.
- 3) *Fibre-reinforced plastic (FRP)* – These are used to strengthen building components structural members for rehabilitation purposes.

### 9.2.1.7 Metals

Metals are recyclable, reusable, very durable, light-weight and can easily be moulded into any shape and form. Metals have limited reserves and very high embodied energy due to high consumption of energy to extract metals from its ore. All metals and metal alloys can in principle be recycled and reused. Through recycling of steel, copper, zinc and lead from waste, energy consumption can be reduced by substantially. The metal can be added to new processes in varying proportions, depending upon the end product and its quality requirements.

Steel and aluminium are the two maximum used materials in buildings, followed by brass (building hardware), zinc and copper (cladding and electrical cables). Steel is used mainly as reinforcement material in concrete or as structural member in steel buildings. Steel building can be dismantled and reused easily unlike concrete. Steel buildings are more earthquake resistant and preferred in earthquake prone areas rather than concrete/masonry buildings. Steel sheets are used for roofing, walls and accessories. Aluminium is used in applications such as, door and window frames, cladding, and roofing sheets. The following recommendations may be considered from sustainability point of view:

- a) Use salvaged metal sections as far as possible.
- b) Use scrap steel and aluminium for non-structural applications.
- c) Use metals with verified recycled content.

The recycled content of metals varies with the type of furnace used for processing. With electric arc furnace the recycled content can be as high as 90 -100 percent, whereas with BOF (basic oxygen furnace) it is about 30 percent. Where feasible, bolted sections should be preferred instead of welded as it helps in reusing the metal sections later; and the sections used should be light-weight, efficient and well designed.

Iron, aluminium, magnesium and titanium can be considered abundant and relatively benign metals, with high recycle potential, even if the environmental consequences of their extraction and production are quite severe. Steel is easy to recover and recycle. Steel with zinc coating or zinc and aluminium alloy increase strength and life of the structure. Virgin chrome, nickel, copper and zinc, however, should be used very sparingly or not at all as natural resources are limited. Copper, nickel and tin can be reclaimed from alloys in which they are the main component. The use of mercury, cadmium and lead should be highly restricted because of their high toxicity. All metals in the long term should

be kept within closed cycles, in order to their loss during production or during the life cycle of the building.

#### **9.2.1.8 *Bamboo***

As an enduring, versatile renewable resource having low embodied energy, bamboo can contribute to sustainable developments and poverty alleviations. It provides healthier environment by sequestration of carbon.

As a building material, it had been abundantly used in the country for traditional huts and hermitages for long besides as scaffolds. With the understanding of its physical and mechanical properties, it has been recognized as an engineering material with scope of designing and constructing moderate houses and other buildings and structures to sustain among others the lateral forces including earthquake forces, etc. Bamboo can be used as structural material in buildings in accordance with Part 6 'Structural Design, Section 3 Timber and Bamboo, Subsection 3B Bamboo' and Part 7 'Construction Management, Practices and Safety' of the Code. Bamboo can replace reinforced steel in tensile zone in certain applications and within limitations. Bamboo-jute composite panels, bamboo boards, bamboo lathe based partitions, flooring boards are also products which can be used for sustainable constructions.

#### **9.2.1.9 *Mortar***

Mortar is a material used to bind as well as to fill the gaps between the bricks or blocks used in masonry construction. Mortar is a mixture of sand, a binder such as cement or lime, and water and is applied as a paste which then sets and hardens. The options available may be:

- a) *Lime mortar* – Lime mortar is mixture of sand, slaked lime and water. This kind of lime mortar, sets very slowly .The speed of setting of mortar can be increased by using impure limestones in the kiln, or a pozzolanic material such as calcined clay. Bricks bonded with hydraulic lime can usually be re-used. Lime mortar is easily workable and when hardened is less brittle and rigid than cement mortar, minimizing the problems of cracks. Hydraulic lime mortar is porous, permeable and thus moisture regulating. Lime mortar is produced at lower temperatures than cement and therefore requires less energy resulting in 20 percent less CO<sub>2</sub> emission.
- b) *Cement mortar* – Portland cement mortar is a mixture of Portland cement, with sand and water. Cement mortar is stronger and more impermeable than lime mortar and is therefore more commonly used for construction of load bearing masonry walls. However, manufacturing of cement is one of the major causes of the greenhouse gas emission. Such mortars having as large replacement of Portland cement as possible by alternative but effective materials, is desirable. For this, use of Portland pozzolana cement or Portland slag cement in place of Portland cement in the mortar shall be preferred.

- c) *Mud mortar* – Mud mortar is prepared by simply mixing soil with water until it is in a plastic (workable) state. Once applied, a mud mortar sets quite rapidly on drying without the need for curing. The beneficial characteristics of mud mortars including good bond to compatible surfaces and ease of preparation allow them to be used in a range of applications such as cob walls, adobe blocks in wall construction, masonry, monolithic walls, and even in flat roofs. However, it has low tensile strength and is subject to shrinkage that causes large number of micro-cracks in the mortar reducing its bond strength and the strength of the whole structure. In addition, mud mortars are liable to increased erosion and loss in strength, if used in humid or wet conditions. Performance of mud mortars can be improved with various additives such as straw to reduce the shrinkage and cement to increase bond strength (but increases structural cracks which can be compensated for by inserting shrinkage joints).
- d) *Lime sand mortar* – Lime sand mortars are a blend of sand and lime to which cement and water is added on site. Cement helps to give mortar early strength and durability, lime helps to achieve greater strength and elasticity over time, and sand acts as an inexpensive filler.
- e) *Lime pozzolana mortar* – The pozzolana traditionally used in the country is *Surkhi* (made by burning clayey soils in a field kiln). Such mortar may be weaker than Portland cement mortar but has better waterproofing properties and has been widely used in dam construction. The use of reactive rice husk as super pozzolana is also a resource efficient option. Combination of burnt clay and rice husk can also be used as pozzolana. Flyash can also be used in the preparation of lime-pozzolana mortar. Mixture of lime-fly ash-sand with 5 percent addition of calcined gypsum can lead to good quality mortars.

NOTE – There are other technologies and materials available locally which use no cement and use flyash and binding agents. These options may be used if performance parameters are met.

For preparation and use of masonry mortars other than mud mortar, reference may be made to good practices [11(13)] and for mud mortar to good practice [11(14)].

#### **9.2.1.10 Glass – See 9.2.3.1.**

### **9.2.2 Surface Materials**

#### **9.2.2.1 Floor and floor coverings**

Stones, ceramic tiles, vitrified tiles, bamboo, linoleum, terrazzo, metal tiles, recycled or reclaimed wood and floorings with high recycled content may be some eco-friendly materials, if used with due consideration to sustainability. Following are recommendations on use of various floor covering materials which may replace conventional materials:

- a) *Finish concrete flooring* – Concrete floor is highly durable, low in maintenance and can cope with water and chemicals. This flooring can be a resource efficient option where the main slab is finished with topping layer of concrete admixed with colourants and sealers. The finishing layer should be stamped with patterns and

grid lines to prevent cracks and for improved appearance. Water dispersed acrylic sealers having lower VOC may also be used.

- b) *Resilient flooring (bamboo and linoleum flooring)* – Bamboo is a natural, renewable, hard wearing and economical option for flooring. Bamboo flooring can be of solid bamboo (made with only bamboo) or bamboo mat board with or without wood veneers. Linoleum flooring is made with reusable and natural occurring material like cork, linseed oil, wooden flour and pine resin. Both the flooring materials require frequent maintenance and can cause indoor pollution if they are VCT (vinyl composition tile) or polyvinyl tile sheet based (release toxic materials in their production). See accepted standard and good practices [11(15)] for linoleum flooring.
- c) *Terrazzo in-situ flooring and tiles* – These tiles may contain up to 60 percent recycled content (crushed stones) mixed with cement. It is a low embodied energy, inert and highly durable and low maintenance flooring. Adhesive used for tiles laying should be of low VOC, non-toxic in nature. Cement mortars with acrylic additives are the better options for adhesive. Refer accepted standards and good practices [11(16)].
- d) *Ceramic/vitrified tiles* – These are durable, have low maintenance requirement and can have high recycled content (clay mixed with up to 95 percent recycled content like recycled glass and crushed stone and feldspar), and are water resistant and may also be recyclable depending upon the pigments added. Ceramic and vitrified tiles have higher embodied energy as compared to terrazzo tiles as there is firing process involved in their manufacturing. Also, these tiles may have pigments (metal oxides), many of which are environmental pollutants, hence rules for proper disposal need to be followed. Low VOC and non-toxic option for adhesive for laying these tiles should be used. Cement mortar with acrylic additives is most suitable and safer option. See accepted standard [11(17)].
- e) *Wooden flooring* – Timber or reconstituted panel products used for manufacture of wooden flooring shall comply with **9.2.1.5**. For protective coating of these products water dispersed urethanes having low VOC (than solvent based), and not having toxic urea formaldehyde should be used. Use of acid cured varnishes and low VOC adhesive is preferred. Finishing of these materials (laminates, veneer or coatings) shall also be of low VOC.
- f) *Stones* – Limestone, marbles, granites are some common stones that last longer than the manufactured tiles. See **9.2.1.4** for stone properties and sustainable alternative.

### **9.2.2.2 External and internal wall finishes**

Selection of materials for external wall finishing is important as it affects the thermal and acoustic insulation of the building and materials for internal wall have effect on indoor air quality (IAQ). Following are recommendations from sustainability point of view:

- a) *Plaster* – Plaster not only acts as a protective covering over walls and provide finishing, but also plays important role in indoor environmental quality of building. There are several alternatives in plaster available, depending on the surface to be

plastered, climate of the place, elasticity, etc. The usual binders are lime, cement and gypsum or the mixtures of these substances. Fibre, mineral fibre, perlite, hacked straw, or even hair from cow, pig and horse are sometimes added for better binding, elasticity and/or insulation. Pigments, if added are generally metallic oxides, which should be fine grained and calciferous. For external plastering or plastering in rooms such as bathrooms, water proofing agents are sometimes added to plaster. The grain size of sand in plaster shall depend on the surface quality required and layers of plasters to be used. The raw material availability of the different component of plaster is generally good. Lime and gypsum based products have good moisture regulating properties. Waste of lime and cement based plaster, being inert can be used as fill. Pure lime plaster can be ground up and used to improve the soil. Dumping sulphur and gypsum waste can lead to sulphur pollution which can be reduced by adding lime. Features of various plasters having effect on sustainability are as follows:

- 1) *Lime plaster* – It is a very old and sustainable method of plastering which require higher degree of skill for good quality work. It is composed of lime, sand and water and is also suitable for use with clayey soils (lime: soil should be between 1:10 and 1:5). In the making of lime-pozzolana plaster, *Surkhi* (made by grounding waste bricks to fine powder), fly ash or reactive rice husk ash can be used in lime mortar. Lime can also be obtained from fertilizer industry (as an industrial waste). Lime plasters have low VOC and have approximately 25 to 28 percent lower carbon dioxide emissions, have lower embodied energy and can contain 50 to 65 percent post-industrial use recycled content. It has wide applicability in restoration of heritage buildings. It is most suitable for internal use but can also be used externally. However, for external use it should be protected against driving rain and continuous dampness, otherwise it may get damaged due to its high porosity. For external use, lime to sand ratio of 1:3 should be used. Lime plaster helps the walls to retain their moisture regulatory properties.
- 2) *Cement plaster*– This is mostly used as an external plaster and can be used on brick masonry, solid concrete walls, concrete block masonry, stone masonry, etc. For internal plaster, the proportions can be 1:6 (cement: sand), whereas for external use they may vary between 1:3 and 1:4 (depending upon the surface to be plastered and the climatic conditions). For application of cement plaster, reference may be made to good practice [11(18)].
- 3) *Cement-lime plaster* – This plaster is used externally. It is somewhat stronger than lime plaster and more elastic than pure cement plaster. In cement-lime plaster, 30 to 50 percent of the binder is cement. For applications of cement-lime plaster, reference may be made to good practice [11(18)].
- 4) *Gypsum plasters* – It is a dry mixture of gypsum and mineral fillers. Gypsum plastering is mainly for internal use especially as a moisture regulating layer, usually having a mix of one part of gypsum and two parts of sand. This mixture sets in 10 min to 30 min. Lime can be added to make the gypsum



plaster usable for longer time. Gypsum is a natural mineral, has quality to absorb pollutant and can also be easily percent recycled completely. This plaster has good compressive strength, and thermal, acoustic and fire resistant properties. Gypsum can be obtained from either natural resources or it can be obtained as industrial by-product or as a product with recycled content. For materials for plaster, requirements and application, reference may be made to accepted standards and good practices [11(19)].

- 5) *Clay plaster* – Clay plaster is a natural, breathable material which is created by composing rocks and minerals, mixed with sand and water to create a workable mix for plastering. It is bio-degradable, absorbs odours, has good sound and thermal insulation properties, is fire resistant and has good temperature regulation properties. Plastering with clay is a quicker method than with traditional gypsum plastering. Long drying time means that it is workable for longer period. However, it is not as strong as other plasters in shear and compressive strength.
  - 6) *Sulphur plaster* – This can be produced by melting sulphur at temperature from 120 °C to 150 °C. Sand, wood flour or the equivalent can be added. It has waterproofing properties but cannot be used over materials with high lime content.
- b) *Mineral and fibre based sheeting/boards* – There are three main types of mineral based sheeting: cement based, calcium silicate based and gypsum based. Raw materials for all the three are abundant. Apart from the binder, they contain fibrous reinforcement. When they are mounted, the joints should be filled with filling material based on plastic binders, mainly PVAC glue or acrylate glue. Production of these sheets is relatively low in pollution. Calcium silicate and gypsum products are also good moisture regulators. Features of such boards having effect of sustainability are as follows:
- 1) *Fibre cement sheets/boards* – These are suitable for all modern and conventional constructions for both internal and external uses as they have high resistance against moisture, fire and termite. It may contain up to 35 percent fly ash and 5 percent recycled pulp and other recycled content, has a long life span, requires little maintenance and is economical. High embodied energy in its creation is compensated by the use of fly ash and recyclable waste. For requirements for some of these sheets reference may be made to accepted standards [11(20)].
  - 2) *Calcium silicate sheet* – These can be used as both internal and external cladding. The sheeting is produced with up to 92 percent by mass of quartz mixed with lime and cellulose fibre. Vermiculite can be used as aggregate. Calcium silicate products can be crushed and recycled as aggregate in concrete. If it is finely ground it can be used in mortars and plaster. The waste is inert and can be used as fill.
  - 3) *Gypsum plaster board* – These boards are manufactured from 95 percent gypsum with possible addition of fibreglass reinforcement (about 0.1 percent by mass). The substances such as calcium lignosulphate,

ammonium sulphate and an organic retardant may also be added to a total of about 1 percent by mass. Pure gypsum sheeting is not too strong; hence, some lime and a large percentage of wood shavings are added to increase strength. The sheeting products are used mainly for internal cladding, and may be covered by wall papers or thin fibreglass woven sheeting for painting. Pure gypsum plaster board is too weak to be dismantled and re-used but it can be broken and recycled and used as 5-15 percent of raw material. However, since gypsum industry is very centralized, it makes it uneconomical to recycle. See **9.2.2.2** (a) (4) for properties of gypsum plaster. For requirement and use of different gypsum plaster boards and material for their manufacture, reference may be made to accepted standards [11(21)].

- c) *Grit wash* – This finish uses waste stone pieces and aggregates like marbles, granites, stones mixed with cement, etc. This is a permanent finish requiring less maintenance.
- d) *Paints and coating* – Generally paints and coatings contain large quantity of VOC and create pollution indoors as well as outdoors (due to release of volatiles by oxidation of both solvent and water based paints). Water based acrylic paints are better option over solvent based oil paints because of durability and lower toxic release. Paints made from natural raw ingredients such as milk protein, minerals, bee wax, natural wax, lime, chalk, talcum, earth and clay pigments and plant oils and resins, should be preferred as they have little to no smell and low VOCs.
- e) *Timber* – See **9.2.1.5**.
- f) *Stone cladding* – Stones can also be used as external wall finishes. However, stone fixing has to be carefully considered for high seismic zone and high rises.
- g) *Metal composite panels (MCP)* – These are formed by bonding two metal skins to a highly engineered plastic core placed between them, creating a sandwich panel. The bonding process occurs under very precise conditions of temperature, pressure and tension resulting in a metal/plastic composite sheet. MCP is used for cladding of building exteriors, entryways, canopies, soffits and facias. Metal skins may be of aluminum, zinc, copper, stainless steel, and titanium. MCPs can be finished in different colours. MCPs are flexible, durable, light weight and easy to install and maintain, weather proof and flexible with low emissivity and high reflectance. MCP shall be fire resistant, which can be achieved by using a fire resistant core in the sandwich construction.

MCPs having high percentage of recycled content and made out of reused plastic core should be preferred.

- h) *Wallpapers* – Wallpapers are for internal use. Wallpapers like grass cloth wall paper, bamboo wallpaper and jute wallpaper are some eco-friendly biodegradable

wallpapers. The grass cloth wallpaper is hand-made from woven natural grasses and therefore is sustainable and manufactured from renewable resources.

### **9.2.3 *Building Fenestration and Detailing***

#### **9.2.3.1 *Glazing***

Glass is a high embodied energy mineral material. Its usage is in skylights, windows, glazing systems, flooring, infill panels for doors. Glass helps to get in natural daylight to interior spaces and provides views. Glazing, if not chosen and positioned in a building properly, may lead to lot of heat ingress/egress.

Glass shall be selected with high recycled content and shall be so sized as to minimize wastages. Use of glazing in fenestration shall be in accordance with **8.1.3**.

#### **9.2.3.2 *Door and window frames***

Frames made of stone, wood, steel, aluminium, reinforced concrete and UPVC are generally used for building construction. Use of stone frame should be preferred in the area where they are locally available as they provide an economical, durable, and termite proof frame. Likewise precast RCC door/window frames are another durable, economical and termite proof alternative. Wooden frames provide better insulation than metal frames. Metal frame although recommended for its durability, high recyclability, light weight and for larger spans, has high heat conductivity. Metal frames are required to be detailed with thermal break (low conductive material) to reduce their conductivity. Frames of plastic and aluminium can be made of profiles filled with foamed insulation of polyurethane to offset high heat conductivity. Composite products are now being available which use either aluminium with UPVC or timber with aluminium, where timber is the insulating material. Inferior quality timber can be used in that case, as the outer layer of aluminium provides weather protection to the same.

Plastic windows are usually made of unplasticized polyvinyl chloride (UPVC) stabilized by cadmium, lead and tin compounds and added colour pigments. All these products have very limited reserves, and cause high level of pollution during processing.

The manufacture of an aluminium and UPVC door and window frame uses very high energy input than a timber/RCC door/window frames. Both UPVC and aluminium windows can be reused if they are initially installed for easy dismantling. Pure aluminium frames can be recycled. Special precautions should be taken to dispose of wastes which contain cadmium, lead or tin. Considerations given in **9.2.1.6** may be followed.

Defective doors of solid timber can usually be recycled or composted but laminated products should be disposed of with special precautions or recycled in incinerators that filter the fume. Considerations given in **9.2.1.5** may be followed for selection of timber for frames. For requirements of wooden frames including such frames eligible for Certification for Eco-Marking, reference may be made to accepted standard [11(22)].

Depending upon the availability or otherwise of various alternatives and their suitability for sustainable considerations, use of precast reinforced concrete door and window frames may be considered as they are highly durable and also eligible for Eco-marking; for quality requirements of this frame, reference may be made to accepted standard [11(23)].

Sealing of frames should be done in accordance with **8.1.3.2.2**.

#### **9.2.4 Climatic Control Materials**

Climatic changes is the prime factor affecting longevity of the building, maintenance of a safe and eco-friendly environment and durability of building materials. There are several historic buildings which have existed for centuries due to the reason that they were built with durable materials to withstand different climatic conditions of the places in which these were built. These materials can be used for climate responsive designs as well as for reducing the harmful impact on environment. **Climate responsive material and designs have added advantage of low cost, ease of availability, ease of reuse and they require minimum processing.**

##### **9.2.4.1 Thermal insulation materials**

The thermal insulation of walls and roof shall be done in accordance with **8.1.1** and **8.1.2**. Thermal insulation materials are used for making a building resistant to heat ingress and egress. A thermal insulator is a poor conductor of heat and has low thermal conductivity. Thermal resistance, thermal conductivity, thermal transmittance, stability, density of materials, long life, fire resistance, lack of odour, low chemical activity, ability to cope with moisture and good thermal resistance are some factors which have to be considered in selecting materials for thermal insulation. **Insulation Performance is evaluated by R Value. The R-value of insulation material for buildings is a measure of how well it resists heat transfer, and is used to indicate how well insulated a building is. A higher R-value means better insulation and greater resistance to heat gain or loss.**

##### **9.2.4.1.1 Types of thermal insulation materials**

Insulation materials may be divided into organic and non-organic groups (mineral fibres, glass wool, perlites) according to their raw materials. Organic materials can be subdivided into more environmental friendly for example natural materials (cork, cotton and wool) and less environment friendly for example synthetic materials (polyurethane rigid foam and polystyrene). Some thermal insulation material may be reflective and some high in embodied energy, which may get offset by saving in the operational energy of the building over their life span.

- a) *Mineral wool* – Mineral wool products are light and have extremely good thermal insulation values. When used as insulation both glass and rock wool need a barrier of suitable material sheeting, partly to avoid dust and partly because the material cannot regulate moisture as required. Exposure to mineral wool fibres may cause

skin problems, itching, eye damage and respiratory irritation. Raw materials are abundant for the main constituents of glass wool and rock wool. The production of glass wool occurs in relatively closed processes where emissions are little and limited to formaldehyde and dust. Large amounts of phenol, ammonia, formaldehyde and dust are released during the production of rock wool, and large amounts of wastes are produced. For requirements of bonded mineral wool, reference may be made to accepted standard [11(24)].

- 1) *Glass wool* – Made from silica sand, limestone, boron, recycled glass (approximately 70 percent), phenol formaldehyde resin or acrylic resin, it is a lightweight and fire resistant insulation material commonly used for duct and wall insulation. Glass wool is a high embodied energy product as glass is melted at higher temperature to make the fibre. Glass wool is easily recyclable and possesses good acoustic insulation properties.
  - 2) *Rock wool* – It is a light weight high embodied energy and fire resistant product, made from natural rock basalt primarily under high heat. It is denser than glass wool and *R*-value is higher than glass wool. Rock wool may contain 10 percent recycled content in the form of building waste and 15 percent recycled content from waste from industry (slag from the steel production process). For requirements, reference may be made to accepted standard [11(25)].
  - 3) *Cotton wool* – This is a rapidly renewable product made from both natural fibres as well as industrial waste from recycled cotton textiles. Cotton is also a good sound insulator, requires little energy to manufacture as well as is non-toxic. Waste cotton, a high water absorbing material should be protected by moisture/vapour barrier.
  - 4) *Natural wool* – It is made with recyclable and renewable source and is non-toxic and bio-degradable. It does not contain any synthetic fibres but has a disadvantage that it absorbs VOC.
- b) *Cellulose fibres* – These can have very high recycled content and can be made from waste papers (about 90 percent recycled papers) or pulverized pulp and are cost-effective. They can also be made from different types of cellulosic materials like card boards, waste papers, old newspapers, cotton, straw, saw dust and hemp. These fibres have very low embodied energy, but they need to be treated for fire retardance (such as by boric acid). This product may be reused and recycled but should not be incinerated.
- c) *Plastic* – Many plastics have good water-proofing and high thermal insulation properties (when produced as foam). As a sealant, plastic can take many forms such as paint, sheeting, paper, sealing strips and mastics. The materials are foamed up using chlorofluorocarbons and carbon dioxide, and fire retardants and stabilizers are added. It is recommended to use products which do not use CFCs or HCFCs as blowing agents during manufacturing. Depending upon how the materials are built in, polystyrene can emit extra monomers of styrene while polyurethane can release small amounts or unreacted isocyanates and amines.

Ashes from the furnaces and plastic waste which is not recycled needs to be disposed of safely to prevent seepage into the groundwater or soil. Properties of polystyrene are as follows:

- 1) *Extruded polystyrene* – This material has very high *R*-value per unit thickness, good moisture resistance, and high compressive strength and is light in weight. It is commonly used in wall and roof insulation.
  - 2) *Expanded polystyrene* – It is a light weight and has high *R*-value, but it has low compressive strength and is not moisture resistant.
  - 3) *Closed cell flexible elastomeric foams* – These naturally resist ingress of water vapour, help in long term efficiency of the insulation and minimize chances of condensation and increased heat gain over a period of time.
- d) *Autoclaved aerated (cellular) concrete blocks* – See **9.2.1.1(f) (2)**.
- e) *Preformed foam cellular concrete blocks*– See **9.2.1.1(f) (4)**. These have better water resistance.
- f) *Hollow concrete block* – See **9.2.1.1(f) (1)**.
- g) *Reflective Insulation materials* – These comprise highly reflective materials like aluminium foil. It may retard the heat transfer up to 97 percent. It is very effective in warmer climates, requires less area, acts as a vapour barrier also, and is non-toxic. However, it has less compressive strength and requires some backing support.
- h) *Perlite and pumice products* – Perlite is a natural glass of volcanic origin. It is pulverized and expanded in rotating kilns at about 900 °C to 1 200 °C, which increases its volume from five to twenty times. It is used either as loose fill insulation or as aggregates in mortar and light weight concrete blocks. Perlite absorbs water, hence moisture preventive materials like bitumen or silicon are sometimes added. It can be used for thermal insulation of buildings, refrigerating rooms and high temperature insulations.
- j) *Vermiculite products* – Vermiculite is formed through the disintegration of mica, which liberates lime and takes up water. When vermiculite is heated to 800 °C to 1 100 °C, it swells to become a light porous mass which can be used as an independent loose insulation or as an aggregate in a lightweight concrete in the proportion of 6 : 1 (vermiculite to cement). Prefabricated slabs can be made in varying thickness from 15 mm to 100 mm using this material. Vermiculite is useful for high temperature areas and equipment. It easily absorbs large amount of moisture, even more than untreated perlite. As normal wall insulation, it has a tendency to settle, hence needs to be compressed substantially after filling into the wall cavity.

- k) *Saw dust and wood shavings* – They are wastes from timber industry or carpentry, and can be used for thermal insulation in walls or ceilings. Saw dust has hygroscopic property due to which it easily absorbs moisture, and then releases it in air and therefore is moisture regulating. Saw dust and wood shavings are chemically inert, non-toxic. However, they are not fire resistant, and the same can be improved by adding pulverized clay.
- m) *Traditional techniques* – Following vernacular techniques have generally been used effectively for thermal insulation of building in the country:
- 1) *Straw-bale insulation* – Straw bale walls (bales of straw commonly of wheat, rice, rye and oats which are agricultural wastes after harvesting) have good thermal insulation properties. These should be packed tightly for improving fire resistance. Straw bale is biodegradable, low embodied energy, non-toxic, easily available, cost effective and rapidly renewable product. These walls are porous in nature hence exposed walls require protection from rain in the form of plaster (generally lime plaster) and deep eaves/verandas.
  - 2) *Inverted earthen pot insulation* – Shading the roof top with inverted earthen pot is an easy and cost effective method to reduce solar gain. In this method roof is covered by inverted earthen pots, the top of earthen pot can be covered with a layer of earth or lime mortar finish or can be left uncovered. By virtue of air trapped within them they provide good insulation. Earthen pots painted with white paints further reduce the heat load. Pots made with earth are recyclable and locally/regionally available.
  - 3) *Brick bat coba* – This system involves laying mortar with broken brick (which may be waste brick pieces) as aggregates and ground brick with lime or cement as binding matrix. A thick mass of brick bats provide the thermal insulation for roof of the building.
  - 4) *Mud phuska*– For this, good quality earth suitable for brick making not containing excessive clay or sand, free from stones, *Kankar*, vegetable matter and other foreign matter should be used. In this system a layer of puddled mud is mixed with grass straw applied on a sand-bitumen waterproofing layer which is then consolidated and plastered with cow-dung mortar. Tile bricks are laid flat on plastered surface and the joints are grouted with cement mortar. All materials are readily available, economical and non-toxic. Laying of mud *phuska* shall be done in accordance with the good practice [11(26)].
- n) *Broken ceramic mosaic tiles* – Broken ceramic tiles can be used as a cost effective external roof finish to reflect the incident solar radiation. Broken ceramic light-coloured tiles reflect heat off the surface because of high solar reflectivity and effectively utilize the waste ceramic tiles.
- p) *Cavity wall insulation* – Cavity wall consists of two layers of masonry separated by a hollow space that work as a thermal insulation as well as provide better sound insulation **and are advisable to use in hot climate**. Cavity wall made with fly ash

blended cement concrete blocks or blocks with high recycled content or internal wall with under burnt clay bricks makes it more environmental friendly. Hollow space between the two walls can be filled with the insulation materials. Rat trap bond is a cavity wall construction technique with added advantage of economy in brick use (of about 25 percent). However, these walls occupy more floor area.

- q) *Poured in-situ cellular light weight concrete* – This work to be done in accordance with accepted standard [11(32)].
- r) *High SRI Paints* – The recent development has been the use of highly thermal reflective paints for the exposed terrace areas which reflects incident heat and adds to the insulation values.

#### **9.2.4.1.2** *Covering or finishing materials for thermal insulation*

These are used to protect and help to elongate the life and usefulness of the insulation from weather, water vapour condensation, and chemical attack and sometimes even from fire. Additionally, appearance coverings are utilized to provide the desired aesthetics. These may include:

- a) *Weather barriers* – These should be installed on the outer surface of thermal insulation to protect the insulation from the weather such as rain, snow, sleet, dew, wind, solar radiation, atmospheric contamination and mechanical damage. Metals, plastics, paints and coatings and roofing felt are few weather barriers.
- b) *Vapour retarders* – These are materials which retard the passage of moisture or vapour into the insulation. Laminated foil-scrim membranes and metal and plastic sheets are vapour retarders.

#### **9.2.4.2** *Moisture and air regulating materials*

Moisture and air regulation in sustainable building is essential to get better indoor environmental quality as well as to protect building and building components from damage. Insulation and other components aimed at controlling seepage of moisture and air to and from building shall be included in the building envelope design. Common air sealing materials include caulks, expanding foams, weather-stripping of doors and windows, gaskets, door sweeps. Another environment friendly technique is to use high recyclable moisture regulating materials like adobe brick and mud construction.

#### **9.2.4.3** *Water proofing materials*

Water proofing materials resist liquid water passing through, but may allow water vapour to pass through. They can be categorized on the basis of application (cold applied or injection type) or on the basis of their types or state (layer type or fluid type).



- a) *Cement based waterproofing products* – These are suitable for both negative and positive water pressures. They contain no solvent. They are however low on elasticity and prone to cracking.
- b) *Plastic-polymer products* – Plastic-polymers have good water proofing properties and have been successfully used due to their light weight, elasticity and non-porous nature. However, there are major limitations from sustainability point of view in using plastic products (see **9.2.1.6**). Some examples are coal-tar, bitumen, ethylene propylene diene monomer (EPDM), polyurethane and PVC, which are briefly described below:
  - 1) *Polymer modified bitumen* – These are available as hot/cold applied fluid products and as sheet membranes.
  - 2) *Polyurethanes/urethane membranes* – These are typically fluid-applied and remain elastomeric (flexible) throughout their useful life. This group of waterproofing membrane materials is commonly referred to as fluid-applied elastomers.
  - 3) *Thermoplastics (PVC) waterproofing membranes* – These are available in sheet forms and are typically applied with heat-welded seams.
  - 4) *Asphaltic membranes* – These typically consist of emulsified (liquid) asphalt and reinforcing fabric, fibreglass or organic, and are applied in layers.
- c) *Brick bat coba* – It provides waterproofing up to some extent. Brick bats coba may be made cost effective by using waste generated during construction or demolition. It works more efficiently if used in combination with other water proofing material. The disadvantages of using brick bat coba are increase in dead load on slab as well as thickness as compared to other water proofing materials [see also **9.2.4.1.1(m)(3)**].
- d) *Bentonite clay* – Bentonite is sedimentary clay composed of weathered and aged volcanic ash. It has the capacity of quickly absorbing large amounts of water and swelling to many times in volume. When the surroundings dry out again, the clay releases its moisture. It is useful as an absorbent waterproof membrane on foundations and foundation walls made of brick and concrete. It is available in rigid, flexible and granular form.
- e) *Other waterproofing membrane materials* – These may be materials such as butyl rubber, crystalline and cementations products. Besides, there are some eco-friendly organo-silicone products based on nanotechnologies which also work as waterproofing materials.

### **9.3 Construction Phase Material Storage and Handling**

It is essential for construction industry to have proper material handling and storage to provide a continuous flow of materials and components and ensure that materials are available when needed and to avoid wastage. For storage and withdrawal of construction materials from storage places, first in first out policy should be followed. Care has to be taken in storing moisture sensitive construction phase materials like cement, Plaster of Paris (POP), gypsum board, wood and other lignocellulosic materials based products, as

well as steel components/materials which may get corroded in the presence of moisture. Inflammable, volatile materials may need proper segregated storage. There may be some materials or components which require to be so stored/stacked as to avoid undue stress over them and ensure safety of the personnel. For guidance on proper stacking and storage of building materials, a reference may be made to good practices [11(27)].

### **9.3.1 Handling of Materials and Equipment**

Handling materials involves diverse operations of crane, truck and manual handling. The efficient handling and storing of materials is vital considering continuous flow through the workplace, and availability. Improper handling may cause severe damages. The workers should be aware of the potentiality of the injuries and hazards due to unsafe or improper handling. During mechanical shifting of materials, one should avoid overloading the equipment.

To reduce potential accidents associated with workplace equipment, employees need to be trained about the proper use and limitations of the equipment. The operating manuals of major handling equipment, for example, conveyors, cranes, slings and industrial trucks should be referred before using these equipment. Periodic inspection and checking of handling equipment should be carried out by the authorized persons only.

## **10 WATER AND WASTE MANAGEMENT**

### **10.1 General**

**10.1.1** The country has been well endowed with large freshwater reserves. However, with the increasing population, industrial activity and pollution, surface and groundwater resources have been overexploited and severely polluted during the past few decades. As a result, the country is faced with immense water scarcity. Growth of the country's economy is driving increased water usage across sectors. Waste water generation is increasing significantly and in the absence of proper measures for treatment and management, the existing freshwater reserves get polluted. Further, increased urbanization is driving an increase in per capita water consumption in towns and cities. Urbanization is also resulting in change in consumption patterns and increased demand for water-intensive agricultural crops and industrial products.

**10.1.2** Significant liquid and solid waste generation is witnessed and recorded in the urban areas of the country. The municipal solid waste generation ranges from 0.25 to 0.66 kg/person/day with an average of 0.45 kg/person/day. In addition, large quantities of solid and liquid wastes are generated by industries. Unless properly managed, most of the wastes generated may find their way into land and water bodies, emitting gases resulting in bad odour and air pollution as well as increase in the emission of greenhouse gases. This problem can be significantly mitigated through adoption of treatment, recycling and processing before disposal, and adopting waste to energy technologies. It not only reduces the quantity of wastes, but also improves its quality to meet the required

pollution control standards and regulations, besides generating substantial quantity of resources and energy [see also **11.16** (c)].

**10.1.3** Sustainable approach to water and waste management requires planning and design of building functions to integrate issues of water and waste management system at the early stages of project evolution, their management during construction activity and subsequently during occupancy and use of building. At the scale of building complex or at township level, the opportunities for water efficiency and waste management are large particularly in respect of external development and landscaping (see **7.1.3**). The sustainable approach should finally adopt an integrated approach to water supply, water waste and solid waste management aimed to create built facilities with zero anthropogenic waste design solution. Following are the broad aspects for achieving sustainable water and waste management:

- a) *Conceptualization, planning and design stage* – Water is essential to create liveable neighbourhoods and public spaces. The function of a water supply system is to provide water from a source identified through considered selection, treat the same to render it suitable for its intended use, and deliver it to the user at the time and in the quantity prescribed. Major considerations during planning and design include yield and quality of raw water sources; topography, geology, population density of service areas; intended uses of water; and treatment of waste water. Since these considerations may vary from project to project, all water and waste management system solutions are unique.

Planning and design of water and waste management system needs a holistic approach. The system should integrate functions, water supply systems, waste water system (including grey water use), storm water management (including rainwater harvesting) and solid waste management and waste to energy systems. The complexity of holistic design process requires coordinated decision-making process.

- b) *Construction stage*– Objective of construction stage is to create the built facility. The concerns of efficient water use and waste have a potential to be ignored. It is essential to establish systems for water and waste management so that the project teams monitor water consumption, control wastes and disposal in an environmentally appropriate manner. The existing surface and groundwater resources should first be protected and suitability integrated in the building and layout plan. There is a scope for selection of materials and technologies, which are water efficient. Value engineering of material and technology selection should be undertaken so that the solutions are appropriate to the project peculiarities as well as environmental constraints. Construction, including in environmentally sensitive sites, necessitates compliance to legal and statutory requirements for water and waste management.
- c) *Performance during use and corrective action* – Building projects are planned, designed and executed in accordance with the anticipated functional use.

However, it is reasonable to expect some variance during use. Building use is a dynamic process and functional use is constantly evolving during life of a building. Also, engineering system designs are optimum solutions based on assumptions, which can only be validated during actual use. Design of systems should be done within a considered tolerance of functional use. The performance of water consumption should be monitored during use and compared with the benchmarks (industry specific, building specific or established standards) given in the Code and corrective actions undertaken. In this respect, it is important to design systems that facilitate monitoring. Appropriate metering and corrective improvements should be integrated in the system design detailing. It may be desirable to design water system taking functional homogeneity into account and facilitate function specific corrections in response to environmental considerations and opportunities for conservation.

## **10.2 Planning and Design of Water Management System**

### **10.2.1 *Planning and Design of Water Supply System***

Planning and design process begins with use analysis for demand assessment, identification of project constraints and water sourcing. Inputs on these parameters are critical design brief contents. Hot water systems are energy intensive building component. Opportunities for waste recovery, temperature setting and selection of technologies that use clean fuels such as solar water heaters need to be included in the planning and design approach for hot water systems. While the systems may be designed efficiently, the strategies for water efficiency and conservation need to be built into the system design. Finally, system components need to be integrated as part of sustainable planning and design approach. Figure 27 gives a typical scheme showing general components of water management system. This shall also incorporate water requirements for fighting fire.

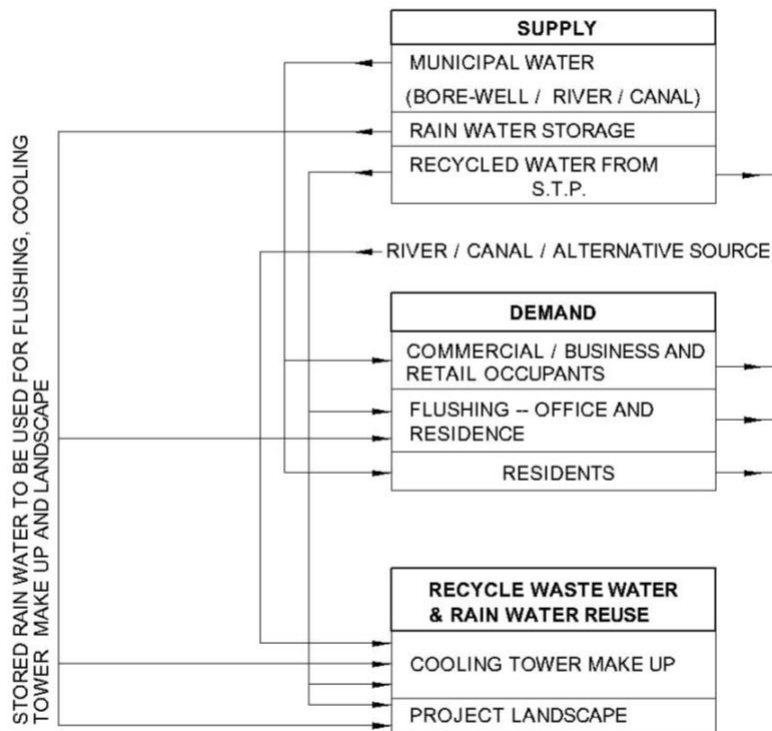

NOTE – In absence and non-viability of having recycled waste water for these purposes/use, river/canal/alternative sources may be considered.

FIG. 27 TYPICAL SCHEME SHOWING GENERAL COMPONENTS OF WATER MANAGEMENT SYSTEM

It is recommended that an overall water balance chart be prepared indicating all supply side resources, infusion of recycled water, and the actual consumption for potable and non-potable and other purposes. This chart should also indicate the extent of recycled water use for different consumption depending on the level of water treatment and reduction in freshwater intake through rainwater harvesting potential of the site.

A reasonably accurate estimate considering a calendar year long demand-supply assessment including demand fluctuations of the amount of water that should be supplied, is needed early in the planning stage of project development. The average daily demand is especially important since it may be used to assess the ability of available sources to meet continuing demands and to size raw water storage facilities that may be required to meet sustained demands during dry periods. Later, during the actual design process, the peak demand is required to properly size pumps and pipelines, estimate pressure losses, and determine water storage requirements so that it may be planned to store sufficient water and cater for daily water demand. Uses of water include agricultural, industrial, household, recreational and environmental activities. Its estimate for fire-safety purposes is also to be addressed in the design stage itself. Almost all of these human uses require freshwater.

### 10.2.1.1 Availability of water

The water availability and the associated features and constraints are as follows:

- a) *Surface water* –Surface water is water in river, lake or freshwater wetland. Surface water is naturally replenished by precipitation and naturally lost through discharge to the oceans, evaporation, evapotranspiration and sub-surface seepage. Although the only natural input to any surface water system is precipitation within its watershed, the total quantity of water in that system at any given time is also dependent on many other factors. These factors include storage capacity in lakes, wetlands and artificial reservoirs, the permeability of the soil beneath these storage bodies, the runoff characteristics of the land in the watershed, the timing of the precipitation and local evaporation rates. All these factors also affect the proportions of water lost.

Human activities can have a large impact on these factors. These often include increase in storage capacity by constructing reservoirs, decrease by reclaiming wetlands and increase in runoff quantities and velocities by paving areas and channelizing stream flow. Also, surface water may be lost (for example, become unusable) through pollution.

The total quantity of water available at any given time is an important consideration. Some users have an intermittent need for water. For example, many farms require large quantities of water in the spring, and very less or no water in the winter. To supply water to such a farm, a surface water system may require a large storage capacity to collect water throughout the year and release it in a short period of time. Other users have a continuous need for water, such as a power plant that requires water for cooling. To supply water to such a power plant, a surface water system needs enough storage capacity to fill in for use later when average stream flow is below the power plant's need. However, over a long term the average rate of precipitation within a watershed is the upper bound for average consumption of natural surface water from that watershed.

Natural surface water can be augmented by importing surface water from another watershed through a canal or pipeline. It can also be artificially augmented from any of the other sources; however in practice the quantities of such water are negligible.

- b) *Under river flow* – Throughout the course of the river, the total volume of water transported downstream will often be a combination of the visible free water flow together with a substantial contribution flowing through sub-surface rocks and gravels that underlie the river and its floodplain called the hyporheic zone. For many rivers in large valleys, this unseen component of flow may greatly exceed the visible flow. The hyporheic zone often forms a dynamic interface between surface water and groundwater, receiving water from the groundwater when aquifers are fully charged and contributing water to groundwater when groundwaters are depleted.

- c) *Groundwater* – Sub-surface water, or groundwater, is freshwater located in the pore space of soil and rocks. It is also water that is flowing within aquifers below the water table. Sometimes it is useful to make a distinction between sub-surface water that is closely associated with surface water and deep sub-surface water in an aquifer.

Sub-surface water can be understood in the same terms as surface water: that is, in terms of inputs, outputs and storage. The critical difference is that due to its slow rate of turnover, sub-surface water storage is generally much larger compared to inputs than it is for surface water. This difference causes a tendency to use sub-surface water unsustainably for a long time. However, over long term the average rate of seepage above a sub-surface water source is the upper bound for average consumption of water from that source.

The natural input to sub-surface water is seepage from surface water. The natural outputs from sub-surface water are springs and seepage to the oceans. If the surface water source is also subject to substantial evaporation, a sub-surface water source may become saline. In coastal areas, use of a sub-surface water source may cause the direction of seepage to ocean to reverse which can also cause soil salinization. People can also cause sub-surface water to become unusable through pollution. The input to a sub-surface water source can be increased by building reservoirs or detention ponds (without lining).

- d) *Desalination* – Desalination is an artificial process by which saline water (generally sea water) is converted to freshwater. The most common desalination processes are distillation and reverse osmosis. Desalination is currently expensive compared to most alternative sources of water. It may be economically viable only for high-valued uses, such as household and industrial uses, in arid areas.
- e) *Rainwater harvesting* – Rainwater harvesting may be employed to augment water availability. See 7.2.1 for details.

#### 10.2.1.2 *Project constraints and source constraints*

Quality aspects of demand depend upon functional requirements, occupancy type, pattern of use, variety of uses involved, occupant use behaviour, cold and hot water quality requirements (temperature, pressure, etc), etc.

Water quality requirements are directly related to intended use. The freshwater is intended mostly for human consumption, whereas treated waste water is intended to be used for non-potable uses. All the water supplied shall meet or exceed appropriate water quality requirements as applicable for its use. Requirements include microbiological, chemical, radiochemical, and aesthetic requirements that are applicable to quality of water for its respective uses.

The quality of available water sources is often a very important factor in water system planning and design. The quality of water for respective uses such as for domestic, flushing, irrigation, processes and construction requirements shall be in accordance with accepted standards and good practice [11(28)].

For estimation of water demand for respective types of occupancy, reference shall be made to Part 9 'Plumbing Services, Section 1 Water Supply' of the Code. Cold and hot water proportion are drawn based on the local climatic condition of the region, type of occupancy and the general use pattern in the local region.

### **10.2.2 Water Sourcing**

Based on the functional assessment of need, availability, environmental concerns and their optimization, the water sourcing is decided. Following are alternative sources of water that are generally suitable for domestic/building water systems:

- a) Direct connection to an existing water system,
- b) Indirect connection to an existing water system (water hauling),
- c) Development of groundwater resources,
- d) Development of surface water resources,
- e) Revamping of traditional water sources, and
- f) Rainwater harvesting.

In majority of cases, in view of operation and maintenance considerations, it may be desirable to connect to an existing water supply system.

During the planning stage of project development, each potential source should be carefully evaluated in light of the water quantity and quality requirements. The final choice of source depends on many factors, such as the following:

- 1) Proximity and capacity of existing systems,
- 2) Necessary institutional arrangements for obtaining water from existing systems,
- 3) Yield and quality of available ground and surface water sources, and
- 4) Level of operation and management activity that is reasonable for the water system being designed.

The source of water is an important factor in deciding which environmental regulations apply, which shall be complied with. For the purpose, the sources may be classified as groundwater, groundwater under the influence of surface water, and surface water. Generally, surface water and groundwater under the influence of surface water, are regulated together.

Source selection should depend upon environmental considerations, reliability, cost (including capital cost and operations and maintenance cost) and water treatment facilities.



### **10.2.3 Hot Water Systems Planning and Design Approach**

Water heating is a thermodynamic process using an energy source to heat water above its ambient/initial temperature. Typical domestic uses of hot water are cooking, cleaning and bathing. In industry, both hot water and water heated to steam have many uses. Appliances for providing a more-or-less constant supply of hot water are variously known as water heaters, boilers, heat exchangers, calorifiers or geysers. In domestic installations, potable water heated for uses other than space heating is known as domestic hot water. The most common energy sources for heating water are fossil fuels namely coal, natural gas, liquefied petroleum gas, oil or sometimes solid fuels. These fuels may be consumed directly or by the use of electricity (which may be derived from any of the above fuels or from renewable sources). Alternative energy such as solar energy, heat pumps and hot water heat recycling may also be used as available, usually in combination with backup systems supplied by gas, oil or electricity. The equipment used should be in accordance with the concerned Indian Standards available.

Alternative hot water systems such as electric, gas fired, oil fired and solar hot water systems; and hot water system using heat recovery are evaluated based on the availability, maintainability and limitation of the fuel feed. Large centralized hot water generation on electrical power should be discouraged and alternative clean and energy efficient fuels with efficient hot water generator should be evaluated in the project having high hot water requirement. All hot water system (equipment and plumbing pipes) shall be insulated with insulation to minimise heat loss.

### **10.2.4 Strategies for Water Efficiency**

Efficient use of water is one of the underlying principles for sustainability in water management. Selection of water efficient products should be considered for both cold and hot water systems. Use of low flow fixtures for faucets, water closets, bath showers, hand-held bidet sprays, dish washers, aerators and clothes washers should be considered. One of the important considerations to ensure performance of low flow products is to design systems with correct pressures.

Low flow fittings should be considered mainly for areas with direct water consumption/human usage such as for wash basin taps, sink taps, and shower head, bath faucet and other faucet taps. Situations where water is filled for other requirements such as bath tub fillers, washing machine and for situations where water is filled, stored, used or situation where quantity of water supply may form the intent for which water is being drawn such as fire-fighting system and swimming pools, need not be provided with water saving features/use. The strategy of water efficiency shall also include low flush and dual flush cistern/flushing mechanism.

Technologies for high efficiency toilets and waterless urinals are emerging solutions but they need to be validated in the realistic use environment. It is important to ensure that the user's functional needs and satisfaction is not compromised. Social attitudes and user habits may need analysis while selecting such products. Dual piping is another strategy

for efficient use of water. Planning and design approach to recycled water use should be integrated with dual piping systems and waste water reuse systems. In such cases, control of contamination in potable supply pipe shall be ensured.

### **10.2.5 Strategies for Water Conservation**

Water conservation strategies aim to conserve the scarce water resource. Storm water is a major opportunity for conservation. Rainwater harvesting and rainwater recharge, and rainwater storage/use have a significant scope for conservation, especially at the neighbourhood level of developments. Rainwater can be harvested by adopting the following means:

- a) Storing rainwater for ready use, in containers above or below ground.
- b) Charging rainwater into the soil (groundwater recharging) to improve the underground water table. This needs to be critically planned as recharge is governed by stratification, groundwater table level and groundwater quality.

While water conservation strategies are most desirable in water-deficient areas, the maintenance of rainwater harvesting system assumes importance, else, they may not perform during raining days. For details reference may be made to **7.2**.

### **10.2.6 Sustainable Design Detailing of Water Supply System Components**

For a system to be sustainable, the aspects of integrated performance, reliability, maintainability, life cycle performance including under adverse conditions and capability to undergo corrections during the use phase of the buildings, shall be considered. Pre-validation of integrated system performance is desirable. It is also desirable to consider implications of procurement, contractually assigned responsibilities and technical support during installation procedures. Quality assurance and quality control systems shall be employed to guide system design and execution.

## **10.3 Planning and Design of Waste Water System**

This involves, quantity and quality assessment study, study of domestic water use-profile and scope of recycled water use, system conceptualization and integration with other water systems; planning for collection, treatment systems (combined and independent sewage and sullage treatment plant), treatment of on-site grey water and reuse. Sludge drying, composting and use for manure should be encouraged with proper hygiene considerations.

### **10.3.1 Treated Waste Water Use for Landscape and Irrigation**

To reduce freshwater consumption for landscape/irrigation, it is suggested to use alternative sources of water, such as grey water, reclaimed water and collected rainwater. Grey water is untreated household waste water from bathroom sinks, showers, bathtubs, and clothes washing machines. Grey water systems pipe carry this used water to a

storage tank for later outdoor watering use. Reclaimed water is waste water that has been treated to levels suitable for non-potable uses. Collected rainwater is rainwater collected in cisterns, barrels or storage tanks.

Appropriate systems to monitor the quality of treated waste water in accordance with the standard practices should be provided while designing and analyzing the building use. Required safeguards should be provided and records of treated waste water parameters should be monitored on regular basis. Quality of treated waste water should be in compliance as required for non-potable and secondary use.

Proper techniques for landscaping and irrigation in respect of selection of appropriate plant species, use of efficient irrigation systems, etc, can result in substantial water saving (*see also 7.1 and 7.3*).

## **10.4 Water and Waste Management During Construction**

### **10.4.1 *Water Use during Construction***

Water from only authorized sources should be used for construction. Use of potable water for construction should be avoided unless required for specific purposes. It is suggested to consider use of treated waste water from appropriate sources with quality of treated waste water parameters confirming the quality required for use in construction activity. Water quality for concreting work shall be in accordance to Part 6 'Structural Design, Section 5 Concrete' of the Code. For sourcing of water, reference should be made to the statutory environmental provisions, if applicable. Inadvertent use of non-potable construction water for drinking purpose shall be prevented by proper distinct systems with appropriate markings. Wastage of construction water in piping network as well as storage tanks shall be prevented. Monitoring of water consumption shall be done by maintaining logs to control wastage and ensure its efficient use. Water efficient construction technologies should be considered along with other implications while deciding on the technology for respective construction activity.

### **10.4.2 *Control and Use of De-watering Output***

De-watering is essential for carrying out construction works below water table. The extent of de-watering is decided on structural considerations. Assigning responsibility within the organization shall ensure control of excessive de-watering. De-watering operations generate enormous amount of water. Organizations should explore to store and use water obtained as a result of de-water either at the site of construction or at another location productively.

### **10.4.3 *Management of Waste Water***

Construction sites may have a constraint of not having a waste-water disposal, hence, the arrangements have to be made within the construction site. It is imperative that the opportunities are identified to reduce the water consumption and re-use treated waste-

water. In the absence of appropriate waste-water disposal facilities, unhygienic and unsightly conditions may prevail which may cause water borne diseases and act as breeding ground for mosquitoes and develops unhealthy environment with bad odour and flies. Wastewater at construction sites may contain residues of construction materials (such as cement, sand, bentonite slurry, etc), oils and domestic waste. It should be possible to treat water, specially containing residues of construction materials and re-use the same in construction. However, disposal of other forms of wastewater should be planned in suitable manner at site after appropriate treatment.

**10.4.4 Waste Management during Construction – See 12.7.**

### **10.5 Process Water Requirement and Effluent Treatment**

Certain processes, such as pharmaceuticals, hospitals, industrial processes, etc, need water quality specific to their needs. Water for such processes is to be provided in accordance with industry standards applicable to the respective industries as well as the applicable statutory environmental provisions. Therefore, planning and design of water supply schemes for such processes shall adhere to the concerned regulations and standards.

Effluent treatment of some special processes is a cause of concern. The impact of treatment of water for supply as well as process effluent shall be assessed through environmental impact assessment (EIA). Environmental management plans (EMP) should be developed to mitigate the adverse environmental impacts. In such situations, it is desirable to establish proper environmental management system (EMS) to ensure compliance to the norms through defined managerial responsibility. For such special process facilities, proper water and effluent quality testing laboratory shall be established and records maintained to control compliance parameters.

### **10.6 Planning and Design of Solid Waste Management System**

Solid waste generated in buildings, if not managed properly may result in unhygienic conditions, spread of foul smell, unsightly conditions and hazards such as fire within the buildings, and hindrance in productive use of building. The solid waste has also bearing on the functional planning of buildings. Collection and movement of solid waste often overlaps with building circulation and, hence can cause interference with the use that may be prohibited in occupancies such as hospitals and hotels. Thus, the interventions during planning and design are critical for solid waste management.

The cumulative effect of improper solid waste management in buildings and its indiscriminate dumping in landfill sites, is an environmental problem of immense proportions. While reduction of solid waste is aimed during building use, as a part of solid waste management it, should be considered to utilize the considerable scope of using solid waste as a resource for waste recycled products and energy. For this, solid wastes recycle facilities should be considered for building complexes. The aim should be to reduce the burden on municipal waste disposal facilities and thereby, reduce the need for

transportation of wastes. Solid waste processing may include sorting out various materials and compacting for effective onward transport to re-cycling plants.

#### **10.6.1** *Documentation of Nature of Waste and Quantification*

For proper planning and design of solid waste management, study of various functional areas shall be carried out. The study should include identification of solid waste that may be generated during use, their characteristics and the anticipated quantities. It may be desirable to study similar projects and take cognizance of their experiences while undertaking such identification.

It may also be desirable to study the socio-cultural context affecting behavioural aspects of users to anticipate extent of their participation in solid waste management process and appreciation of systems implemented. In planning solid waste management system from sustainability point of view, the role, responsibilities and response of users should be considered. The context of users, characteristics of waste and expected quantities shall be documented for making strategic decisions.

#### **10.6.2** *Identification of Strategies for Solid Waste Management*

Considering the solid waste characteristics, expected quantity, socio-cultural context of users and possible technological solutions, strategic planning of solid waste management shall be developed. Technological and managerial alternatives shall be explored and compared. Reference shall be made to the statutory provisions governing building use and the environment. While developing strategies, the following aspects shall be considered:

- a) Solid waste minimization;
- b) Space requirement for collection sorting, movement for sorting and for disposal, including on-site pre-processing and off-site transport in accordance with legal provisions;
- c) Effectiveness of possible alternatives;
- d) Environmental sensitivity for solid waste processing and constraints of off-site disposal;
- e) Organizational constraints of building occupants to participate and involve in management of solid waste; and
- f) Economic considerations of technology and their reliability.

The strategic approach to solid waste management shall be documented as a report that shall form a basis of planning and engineering services design.

#### **10.6.3** *Solid Waste System Planning*

Documented strategic approach should lead to planning of the system as the preliminary design begins to evolve. Design configuration shall consider solid waste management also as one of the functions of the building. Planning and design shall include appropriate physical space requirements for,

- a) provision for collection at suitable locations for solid waste to facilitate the occupancy functions;
- b) need for ventilation, washing, isolation and provision for persons performing duties of waste collection;
- c) provision of appropriate containers for wastes;
- d) circulation planning for solid waste from individual collection locations to central facility (for example, waste chutes, physical movement through service corridors, etc);
- e) segregation space with necessary illumination, ventilation, washing and other provisions for performing segregation duties at appropriate location(s);
- f) treatment facility within the building or building complex for compacting for recycling and disposal (for transport to city level facility), composting for biodegradable waste, re-cycled materials, and heat recovery during disposal through thermal chambers; and
- g) composting and manure generation systems in buildings, clusters, neighbourhoods, districts and city levels.

Composting and manure generation at all levels opens up channels to capture substantial part of biodegradable waste and increases green activity like gardening and vegetable growing. The system can reduce, recycle, reuse and regenerate as per sustainability concept. Adequate protection shall be provided to segregate waste area to permit restricted access to only authorised personal. Access to birds and animal should be strictly avoided. The solid waste disposal system should try to use the combustible but non-recyclable items like dry plant parts, wooden wastes, fabric waste, etc, for waste-to-energy systems at district level on wards. Using combustible garbage items for energy generation will reduce volume of garbage to be disposed, transportation along with requirement of land fill sites. Energy generation will reduce the carbon foot print of the area/zone and hence the sustainability of the building.

A schematic plan for solid waste management shall be developed and coordinated with the building plan. Schematic plan shall also indicate technologies employed in the process of solid waste management after due consideration to alternatives, cost implications to the project; statutory approvals that may be needed; specifications of civil and engineering works needed to be executed, contractual conditions for executing agencies; etc. Documented plan shall be the basis for preparing detailed designs.

#### **10.6.4 Design Detailing of Solid Waste System Elements**

Design of solid waste system shall coincide with detailed architectural and engineering design. While physical space requirements are necessary for the architectural design, design calculations for engineering services requires inputs from various elements of waste management. Design detailing should be adequate to ensure information needed for vendor selection and tender action.

System design detailing shall ensure that the components are compatible with each other. For instance, the design of segregation facility shall consider aggregate space requirement arising out of various collection locations. Similarly, the quality of finishes should be compatible with the nature of waste and the processes needed.

From sustainability considerations, it is desirable that the representative group and other stakeholders review the proposed solid waste management system, including technical and managerial component, so that the performance is assessed from multiple standpoints. See also Part 9 'Plumbing Services, Section 3 Solid Waste Management' of the Code.

#### **10.6.5 Provisions for Waste(s) Requiring Special Management**

Wastes generated in special occupancies and processes need safe handling and disposal in accordance with industry practices, and statutory and environmental laws. Buildings are required to make special provisions, physical spaces and measures to collect, segregate, transfer and dispose of the waste. Management system should be established for disposal of such special wastes. Management systems should define delegation of responsibilities, prerequisite competencies, procedures, protection for personnel performing waste management duties and procedures for emergencies and disaster management. Issues related to wastes requiring special management shall be taken care of as follows:

- a) *Biomedical hospital waste management* – Hospital wastes include human parts, infectious materials, shrapnel (needles, surgical blades, etc) and radioactive materials. Each of the waste types shall be collected and segregated at designated locations as per the norms applicable, with adequate precautions for safety, disinfection and containment. The circulation route for waste shall be segregated from other hospital circulations. Location for further processing of waste for final disposal shall be defined at the master planning stage. Special care shall be taken for ventilation exhaust so that the same does not mix with air intakes in hospital ventilation system. The hospital waste shall be treated using appropriate technologies like incineration, autoclaving, microwave or hydroclave and also as per the statutory laws and procedures.
- b) *Management of radioactive waste* – Disposal of radioactive waste shall be carried out strictly in accordance with the Board of Radiation and Isotope Technology (BRIT)/Atomic Energy Regulatory Board (AERB) regulations/guidelines. In such cases, proper records shall be maintained as required by the regulatory authority concerned.
- c) *Management of toxic and chemical waste* – Toxic chemical wastes shall be disposed of according to the relevant regulations, standards and best industry practices. Under no circumstances, these should be disposed into sewerage. Specific arrangements shall be provided for management of emergencies such as control of spread of toxic fumes and emergency health care to the exposed populations.

- d) *Management of inflammable and combustible wastes* – Combustible and inflammable waste is a potential source for fire hazards in buildings. Collection, segregation and handling of such wastes shall not be carried out in vicinity of any source of ignition. Adequate provisions for spread of smoke and fire-resisting enclosures shall be provided at locations for collection and segregation. Necessary fire protection measures, such as portable extinguishers, fire hydrants and sprinklers should be provided considering fire risk, damage potential and statutory provisions. Provisions under explosives act shall be followed for storage and disposal, as applicable.
- e) *Management of electronic waste* – These shall be taken care of in accordance with the applicable act, rules and regulations relating to the management and handling of e-waste.

## **10.7 Integrated Approach to Water Supply, Water Waste and Solid Waste Management**

An integrated approach towards water supply, waste water and solid waste management should be adopted with a view to meeting the objectives as given in **10.1** to **10.6** in respect of these.

**10.8** The construction and demolition waste management shall be done in accordance with **12.7**.

## **11 BUILDING SERVICES OPTIMIZATION**

### **11.1 General**

Optimization of electro-mechanical services is one of the important aspects towards achieving a sustainable building. Reduction in heating, cooling and lighting loads through climate-responsive designs and conservation practices can enhance the energy efficiency of a building. In addition, an integrated project delivery (IPD) approach results in a well-designed, cost effective solution wherein all building systems and components can in coherence facilitate overall functionality as well as required environmental performance. The passive design features and proper initial planning helps in reduced energy demand and, therefore, the same should be carefully analysed prior to actual sizing of equipment where provided.

### **11.2 Concept Development**

In addition to achieving the optimum energy performance, the building should also provide the desirable thermal and visual comfort to its occupants. Incorporating solar passive techniques in a building optimizes building performance by minimizing the use of artificial energy and thereby minimizing load on conventional systems for heating, cooling, ventilation, lighting, etc.



Solar passive techniques that can be adopted in different climate zones of India are,

- a) landscaping (to reduce heat island effect);
- b) optimum building orientation;
- c) arrangement and shape of buildings;
- d) effective surface to volume ratio;
- e) location and size of openings on building facade and other elevation;
- f) glazing type and performance; and
- g) shading devices on windows and judicious selection of building materials.

Prior to developing the design drawings, the design team shall carry out a thorough review of the fundamental assumptions, owner's brief and available resources on site, in an integrated manner, addressing the key target issues such as the following:

- 1) *Building orientation* – Building orientation affects many aspects ranging from energy performance to visual simulation of the building. Building location and its exposure to solar direct radiation affect the HVAC design, day-lighting strategies and the overall energy demand.
- 2) *Building envelope* – Building envelope provides a starting point for determining heat transfer coefficients for external walls/ceiling/roof and glazing (see 8 for details).
- 3) *Harvest site energy* – Project shall explore the use of natural resources such as daylight, variations in ambient temperature (economizer cycles) to reduce cooling/heating demand and utilize solar/wind energy. For large projects, the master planning team should explore district level solutions and identify potential site integrated opportunities.
- 4) *Design assumptions and internal load assessment* – Energy demand reduction may be accomplished by carefully analysing the initial design assumptions and by reducing internal heating and/or cooling loads and interior lighting improvement. It can be achieved through multiple design strategies such as reducing the overall building footprint, reviewing the indoor temperature design criteria to allow for a wider acceptable band, on-demand operation of utilities (using sensors to link the operation to an established criterion), climate responsive envelope, etc. In case of air-conditioned building, the project team may also consider a review of indoor design temperature (which is consistent with adaptive thermal comfort model) as every degree shift closer to outdoor design temperature can help in optimizing the equipment sizing. In addition, the thermostat set point temperature can be kept closer to seasonal average outdoor temperature during regular operation to building energy consumption.
- 5) *Maximize efficiency* – Energy consumptions should be optimized to avoid over-sizing of equipment rating. It may be achieved by analysing the estimated monthly and annual energy consumption profiles of the building and compare the same with building peak loads. Computer based design tools may be used to identify feasible energy conservation measures for a building.

### 11.3 Natural and Mechanical Ventilation Strategies

The term natural ventilation is used to describe air movement caused by naturally produced pressure differences due to wind and the stack effect. Natural ventilation is achieved by infiltration and/or by allowing air to flow in and out of a building through doors, windows, openings, louvers and *Jalis*. Typically, preferred mode of ventilation in non-air conditioned spaces is by natural draft or convection. A thorough assessment of natural versus mechanical ventilation strategy should be performed to minimize the need for artificial cooling by lowering the space temperatures (of attics) as well as eliminate/minimize the need for mechanical blowers. For this, validation through computer simulation may be helpful. Following are some of the important aspects which may be considered for the purpose:

- a) *Stack effect* – Convective air currents may be induced in a building by exploiting temperature difference between a space and the environment adjacent to it as the lighter warm air rises to be replaced by cooler air. This phenomenon may be especially useful for ventilation in tall buildings, vertical passages such as stairwells, elevators, and shafts. This helps in reducing the fan power energy demand.
- b) *Wind-induced pressure differences* – Wind pressure on a building depends on wind direction, speed, shape of the building and location of its openings. The spatial cooling techniques may be explored through windows/openings to induce airflow from the windward side and outflow on the leeward side. This is especially suited for tall buildings.
- c) *Night purging* – Night purging takes advantage of the diurnal variation in temperatures to lower the cooling demand of the space. In regions, where a significant difference exists between day and night temperatures, this technique is useful for dissipating heat by flushing the indoor space through ambient cool air.
- d) *Wind towers* – Use of wind towers may be explored in hot and dry climates for cooling. The function of this tower is to catch cooler breeze that prevail at a higher level above the ground and direct it into the interior of the buildings. Wind towers operate in many ways depending on the time of day and wind availability.

### 11.4 Passive Heating Techniques

Passive heating is the spontaneous warming effect resulting from the absorption of solar radiation wherein solar energy is exploited to induce heat flow from the affected surface to indoor air, as well as promote heat storage within the building structure. In the climatic zones requiring indoor space heating, it may be explored to use the following strategies:

- a) *Direct gain method* – Controlled sun may be permitted into the habitable spaces through an opening to directly heat the floor, walls or other internal components and objects, which, in turn, heat the air within the room. Some examples of building materials that enable direct solar gain by acting as thermal storage mass are concrete, bricks, stone and water. The high thermal mass is usually located in the internal or external walls, floors or other built-in structures that receive sun directly.

- b) *Indirect gain* – A thermal storage wall may be placed between the glazing and habitable space which prevents solar radiation from directly entering the living space. The solar energy incident on wall is absorbed by the wall and then indirectly transmitted to the habitable space over a longer time.
- c) *Trombe wall* – It is a thick solid wall with vents at its lower and upper ends. This wall may be placed directly behind the glazing with an air gap in between. The vents act as inlets of warm air into the room and as outlets for flushing out cool air from the room.
- d) *Solar chimneys* – This system is a kind of modified trombe wall that is incorporated into the roof. A solar chimney is essentially a collector panel with minimum thermal inertia on the south facade of the building. It absorbs incident solar radiation and heats up the air inside the space.
- e) *Sunspaces/Solaria* – It is an integration of direct gain and thermal storage concepts. Solar radiation admitted into the sunspace heats up the air, which by convection and conduction through the mass wall reaches the habitable space. It essentially consists of a greenhouse constructed on the south side of the building with a thick mass wall linking the two.

### 11.5 Passive Cooling Techniques

Passive cooling systems rely on natural heat sinks to remove excess heat energy from a building. They derive cooling directly from evaporation, convection and radiation without using electrical energy. All strategies rely on diurnal changes in temperature and relative humidity. The applicability of each system depends upon the prevailing climatic conditions.

The building envelope can be designed to effectively exchange heat with the surrounding ambient air. In order to have an appreciable net heat flux between two bodies, the temperature difference should be significant (typically at least 7 °C). Some of the techniques are as follows:

- a) *Nocturnal cooling* – In this technique, night sky cooling may be very effectively used to dissipate the heat stored in building envelope so that it is regenerated to store the day heat gain. Such buildings will require high thermal mass and application is ideally suited for day use buildings such as offices.
- b) *Roof pond with movable insulation* – A water body on the roof may provide cooling where during summers it is covered with insulation with a surface finish of low absorptivity. During the day time, this minimizes the solar radiation impact on the roof, as the water in the pond holds the heat gain and further increases the time lag. During the night, insulation is removed and the heat stored in the day time is exchanged with the night sky. In winter, the operation of the movable insulation is reversed to allow heat gain in daytime and reduce heat loss during the night. All such provisions shall however be without prejudice to the need of compliance to the requirement of structure safety as prescribed in this Code.

- c) *Courtyards* – Due to incident solar radiation in courtyards, the air gets warmer and rises. Cool air from ground level flows through louvered openings of rooms thereby inducing airflow.

### 11.6 Pre-cooling of Ventilation Air

To conform to the IAQ requirements, it is necessary to introduce outside air for ventilation of conditioned spaces. This enables reduction in internal air-contaminants, as well as dilutes odour from occupants. The introduction of hot and humid air leads to significant increase in cooling/heating load and, therefore, strategies, as follows, may be considered to minimize the energy demand:

- a) *Demand controlled ventilation* – Carbon dioxide or air quality sensors may be used to check the level of pollutants in the occupied space and provide the indication to building management system to control the opening of outside air dampers thereby effectively providing ventilation on demand.
- b) *Heat recovery* – Pre-cooling of hot/cold outdoor air can be achieved by recovering energy from exhaust streams of a building (toilet/pantry/atrium) through either heat recovery wheel, run around coils, cross plate heat exchangers or heat pipes. This helps in lowering the installed capacity of cooling/heating equipment.
- c) *Economizer cycles* – In certain climates, air and/or water side economizer cycles may be used to take advantage of lower ambient air temperatures. Outside air load may be reduced by pre-treating the air and possibly combining strategies like earth air tunnel and adiabatic cooling.

### 11.7 Low Energy Mechanical Cooling Techniques

It is desirable to explore possibility of using low energy cooling/heating techniques for indoor space as an alternate for compressor driven energy intensive conventional air-conditioning systems. Passive systems in combination with mechanical systems may also be suitably hybridized to offer systems that have significant lower energy consumption in comparison to conventional HVAC systems. The following alternative technologies may be considered for implementations to comply with the comfort criterion:

- a) *Evaporative cooling* – It is suited for hot climates with low humidity. The cooling of air is achieved by simple evaporation of water in air. In high humid climates, evaporative cooling may have little thermal comfort benefit beyond the increased ventilation and air movement it provides. Various types of evaporative coolers are as follows:
  - 1) *Direct (single stage) evaporative cooling (open circuit)* – It lowers the temperature of air by using latent heat of evaporation thereby changing water to vapour state.
  - 2) *Indirect evaporative cooling (closed circuit)* – It is similar to direct evaporative cooling, but uses a heat exchanger. In addition, in indirect evaporative cooling, the cooled moist air does not come in direct contact with the conditioned

- environment. Efficiency of these systems is low as compared to direct evaporative cooler.
- 3) *Two-stage evaporative cooling or indirect-direct system* – It does not produce humidity levels as high as that by traditional single-stage evaporative coolers, but operate at a lower efficiency. Two stage evaporative coolers combine indirect with direct evaporative cooling.
  - 4) *Passive (or natural) downdraft evaporative cooling (PDEC) system* – It is a low energy passive system. PDEC system does not need the blower and require only pump for re-circulating water. Some designs may even eliminate the re-circulation pump and utilize the pressure in the supply water line to periodically surge water over the pads thereby eliminating the requirement for any electrical energy input.
- b) *Desiccant dehumidification/cooling systems* – Desiccant dehumidification/ cooling technology provides a tool for controlling humidity levels for conditioned air spaces.
  - c) *Geothermal heating and cooling* – Geothermal exchange loop use the constant temperature of the earth as the exchange medium instead of the outside air temperature. As the ground is warmer than ambient air during winters and cooler than ambient air during summers, geothermal exchange loop harnesses this phenomenon by exchanging heat with the earth through a ground to water/air heat exchanger. Thus it helps in meeting indoor heating/cooling demand and also hot water generation for small scale buildings like homes and commercial establishments. Geothermal exchange loop can be classified as closed looped system and open loop system. The pipes can be installed in three ways, namely, vertically, horizontally and in a pond or lake, depending upon the availability of land area and soil type at the chosen site.
  - d) *Earth air tunnel system* – As earth temperature remains constant throughout the year at a depth of 4 m to 5 m, an earth air tunnel (EAT) is created by burying a pipe at this depth. Ambient air, thus sucked from one end is passed through EAT and depending on the ambient temperature, air gets cooled in summer and heated up in winter. This cooled/heated air is then supplied to the various areas in the building for meeting space cooling/heating demand and can provide recommended thermal comfort to the building occupants.
  - e) *Radiant cooling or thermally active building systems* – These systems work on the principle of thermal storage of energy (heating/cooling) within the building structure components such as slabs, false ceiling, walls, etc. Further the building components radiate the heat/coolness to the building interiors thereby off-setting the heating or cooling loads. These systems specially work best in climates with high diurnal variations. These systems can be integrated with the HVAC system or can operate independently.

## 11.8 HVAC System

The following may be considered with regard to planning, design and installation of HVAC system:

- a) *Equipment sizing* – As the air conditioning system account for nearly 50-60 percent of annual electricity bill for a conditioned building, prior to equipment selection, it is important to optimally size the cooling and heating equipment of the building. As the internal loads may not peak simultaneously at any given time, a suitable diversity factor may be considered for sizing the equipment. Multiple smaller machines, chiller with multiple compressor or variable frequency drive (VFD) on chiller may be explored for ensuring operation at highest efficiency point in spite of variation in demand.
- b) *Unitary/split equipment* – The unitary products like window air conditioners and split units are ideally suited for standalone smaller applications like houses and shops. However, the IAQ and energy efficiency need a special attention. These shall conform to relevant Indian Standards.
- c) *Variable refrigerant flow systems* – These are the systems for middle size commercial establishments like shops, small hotels, nursing homes, restaurants, large residences, bank, education institutes, small office, etc and can provide a superior performance over conventional unitary equipment/package units. However, the IAQ, redundancy and long refrigerant pipe lengths required, need a special attention.
- d) *Central plants* – These are ideally suited for all medium and large scale projects that require air-conditioning wherein the chilled water is transported to remote air terminal units for heat transfer. The water chilling machines (chillers) are categorized with respect to type of compressor and heat transfer mechanism. Their selection calls for a careful review in terms of anticipated variation in load, part load efficiency, redundancy, etc. The benefits of central plants include highest efficiency, reduced maintenance costs and overall lower total installed capacity (due to overall diversity) in comparison to other options.
- e) *Water chilling machines (chillers)* – Chillers may be used either singularly or in groups and in either air-cooled or water-cooled options. As a guideline, air-cooled chillers are recommended when water is either in scarce supply and/or expensive or in case the ambient conditions are favourable. Water-cooled chillers are more energy efficient than the air-cooled chillers but do require a cooling tower which demands a supply of suitably treated water. Cooling Tower may be provided with side stream filtration system to conserve water that is wasted away during blow down. They have a longer operational life and are often selected for larger capacity applications. It is worthwhile to look at other saving strategies like heat recovery (heat machine/heat pumps/de-superheater/double bundle condensers/condenser heat recovery/heat recover in AHUs), possibility of hybrid cooling options or closed

cell cooling towers to reduce energy consumption. The use of recycled water from a sewage/effluent treatment plant for cooling tower make-up is desirable.

There are two recognized methodologies to determine chiller efficiency namely coefficient of performance (COP) and integrated part load value (IPLV). This offers a mathematical way to rate and compare single chillers but is not suitable for multi-chiller configurations. With energy modelling, multi-chiller configurations may be simulated with greater accuracy. Early use of recognized modelling software in the design process may help in addressing common design shortcomings such as, the tendency to over-size chiller installations.

Parameters that need to be optimized while designing a chiller-water plant include flow rates and temperatures, pumping options, plant configuration and control methods. For each specific consideration, the design professional should understand the owner’s need, objectives and implement the chiller plant options to best satisfy them.

It is also worthwhile to look at other energy saving strategies like heat recovery (heat machine/de-superheater), low flow applications (higher  $\Delta T$ ) on chiller and condenser, low approach cooling towers, series counter flow configuration, use of variable frequency drives, advanced controls, water economizers, lower fouling factors, higher chilled water temperature, etc, for reducing the energy demand. In addition, use of VFD in compressor may also be explored in case it offers improved part load efficiency.

- f) *Refrigerants* – Refrigerants are classified into two classes based on their toxicity, namely class A having lower chronic toxicity and class B having higher chronic toxicity. They are classified into four classes based on their flammability, namely, Class 1 (no flame propagation), Class 2L (lower flammability), Class 2 (flammable) and Class 3 (higher flammability).

Refrigerants shall be designated and classified for safety in accordance with the accepted standard [11(33)].

1) *Matrix Diagram of Safety Group Classification System*

The toxicity and flammability classifications for refrigerants as above yield eight safety groups, namely, A1, A2L, A2, A3, B1, B2L, B2 and B3. These safety groups are represented by the matrix shown below:

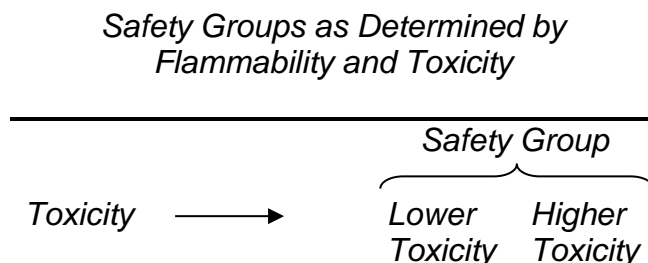

*Flammability* ↓

Higher Flammability	A3	B3
Flammable	A2	B2
Lower flammability	A2L	B2L
No flame propagation	A1	B1

- 2) While selecting refrigerants, manufacturers and designers shall adopt balanced approach considering environmental impact and human health. The key criteria that shall be considered are as follows:
- i) *Ozone depletion potential (ODP)*- ODP of the refrigerant should preferably be zero and shall be as permitted under *The Ozone Depleting Substances (Regulation and Control) Amendment Rules, 2014* as amended from time to time (see Note);
  - ii) *Global warming potential (GWP)*- GWP of the refrigerant should preferably be as low to reduce green-house gas (GHG) emissions, which is in line with the ongoing discussion for phase-down of production and consumption of hydrofluorocarbons (HFCs);
  - iii) Refrigerant with zero ODP and low GWP should be adopted for balance approach considering overall environmental impact;
  - iv) *Flammability* - *The refrigerant* should preferably be non-flammable/having flammability as low as possible, and suitable risk mitigation process/infrastructure (sensors, ventilation, etc) should be opted to mitigate the risk of flammability, if any in line with the accepted standards;
  - v) *Toxicity* – The refrigerant should have toxicity as low as possible, and suitable risk mitigation strategies/infrastructure (sensors, ventilation, etc) should be opted to handle toxicity, if any in line with the accepted standards; and
  - vi) The refrigerant should also support other key performance parameters, including energy efficiency, low emissions, chemical and thermal stability and material compatibility.

NOTE – The production and consumption of ozone depleting substances (ODS) including HCFCs, for example, HCFC-22 and HVFC-123 is being phased out by 2030. The import of refrigeration and air conditioning equipment containing HCFCs has already been banned from 10 July 2015, and the manufacturing of all such equipment with HCFC will be banned in the country from 01 January 2025 in accordance with *The Ozone Depleting Substances (Regulation and Control) Amendment Rules, 2014*.

For ODP, GWP and safety group (flammability and toxicity) of different refrigerants, reference shall be made to Table 14. As there are ongoing developments with respect to refrigerants with HCFC Phase-out Management Plan (HPMP) and HFC phase down proposals, latest regulations applicable at the time of selection of equipment/systems with various possible refrigerants shall be followed. As research is going on for alternative refrigerants to various HCFC/HFC/HFO refrigerants, it is recommended that project teams should make



a conscious effort to select equipment/systems with refrigerant with high energy efficiency, least negative impacts on health, safety and environment as per the latest developments.

**Table 14 ODP and GWP Values (100 Year Values) and Safety Group of Different Refrigerant Types**  
[Clause 11.8 (f)]

SI No.	Refrigerant		ODP	GWP	Safety Group {see accepted standard [11(33)]}
	Refrigerant Number	Composition Designating Prefix			
(1)	(2)	(3)	(4)	(5)	(6)
<b>i) Hydrochlorofluorocarbons (HCFC):</b>					
a)	R-22	HCFC	0.055	1 810	A1
b)	R-123	HCFC	0.02	77	B1
<b>ii) Hydrofluorocarbons (HFC) and their Blends:</b>					
a)	R-32	HFC	0	677	A2L
b)	R-134a	HFC	0	1 300	A1
c)	R-245fa	HFC	0	858	B1
d)	R-404A	HFC	0	3 922	A1
e)	R-407C	HFC	0	1 774	A1
f)	R-407F	HFC	0	1 825	A1
g)	R-410A	HFC	0	1 182	A1
h)	R-507A	HFC	0	3 985	A1
j)	R-448A	HFC	0	1 386	A1
<b>iii) Hydrofluoroolefins (HFO):</b>					
a)	R-1233zd(E)	HFO	~0	1	A1
b)	R-1234ze(E)	HFO	0	0.97	A2L
c)	R-1234yf	HFO	0	0.31	A2L
d)	R-1336mzz(Z)	HFO	0	2.0	A1
e)	R-514A	HFO	0	1.75	B1
<b>iv) Hydrofluoroolefins (HFO)/Hydrofluorocarbons (HFC) Blends:</b>					
a)	R-452A	HFO and HFC blend	0	2 141	A1
b)	R-452B	HFO and HFC blend	0	675	A2L
c)	R-513A	HFO and HFC blend	0	573	A1
<b>v) Natural Refrigerants:</b>					
xiii)	R-718 (Water)	-	0	0	A1
xiv)	R-744 (Carbon dioxide)	-	0	1	A1
xv)	R-717 (Ammonia)	-	0	0	B2L
xvi)	R-290 (Propane)	HC	0	3.3	A3

g) *Chilled water pumping systems* – In a central plant, the pumping systems contribute to second largest energy consumption source and it should be carefully analyzed for selection for highest efficiency point and required head only. It is recommended to install variable frequency drives for all applications. There are following two types of chilled water pumping system options:

- 1) *Primary-secondary (decoupled) system* – In this system, flow rate through each chiller remains constant and yet accommodates a reduction in pumping energy, since the system water flow rate varies with the load.
- 2) *Primary only variable flow (PVF) system* – In this system, flow varies through evaporator. It helps in saving on initial as well as operating costs/energy. The control strategy/priorities of a PVF system are significantly different from that of a primary-secondary system.

h) *Thermal energy storage (TES)* – TES is a technique ideally suited for utilizing advantage of differential power tariff and power rationing during peak load hours. This becomes a tool for use by the designer as conventionally peak load may be considered as refrigeration load for selecting equipment capacity; thus, in such case most part of day refrigeration machine operates at part loads or kept idle. To overcome this shortcoming, concept of thermal energy storage may be evaluated to store the energy during the time when load is less than installed capacity and releases the energy when the load is more.

Thermal storage systems may be suitable for situations wherein, due to water shortage the usage of water cooled chillers are limited. The air-cooled chillers may run during nights when the ambient temperatures are lower. Also, the technique may help reduce the size of the refrigeration equipment, installed electrical sub-station equipment and power back up requirement. Recommended to evaluate the option of placing ice/chilled water storage tanks in parallel/series arrangement.

j) *Vapour absorption system* – Alternate sources of energy particularly waste steam/heat may be used for refrigeration. One such system uses water as the refrigerant and lithium bromide as the absorber. It has less moving parts and hence results in lower power consumption. Vapour absorption system may also utilize waste heat from the diesel/gas generating sets/bio-waste using heat recovery boilers or heated water from the solar panels to produce cooling in buildings.

Vapour absorption machines may also be considered in co-generation systems.

k) *Air handling units (AHU)* – Choice of air handling units with supply and return/exhaust air fans may help in energy saving. During free cooling conditions when the ambient temperature is comfortable, the supply fan draws all outside air, whereas the return/exhaust fan exhausts the air from the conditioned area. The air handling unit with VFD may be considered so as to meet the varied air quantities for various seasons. This can work in tandem with a variable frequency drive.

The air handling units work in sequence with heat recovery wheel with which the fresh air drawn may be cooled by return air resulting in energy saving while maintaining the IAQ levels which requires higher outside air. Toilet exhaust fans may be connected with an infrared sensor/timer or such other means which facilitates operation only during occupancy.

- m) *Server rooms/data centre* – Facilities such as server rooms and data centre that require round the clock operation and high energy demand are beyond the purview of this Part. However, as smaller server and hub rooms are part of every building that has multiple computers, for such installations use of dual fluid precision units may be considered. When the chiller is in operation the unit is running in chilled water mode and shifts to direct expansion (DX) mode when the chiller is not functional. When the chilled water temperature is maintained higher, it can run on both chilled water and refrigerant mode so as to meet the duty conditions. The blowers may be of variable volume type or with electronically commutated (EC) motors to meet varying duty conditions. Where DX system is used, its unit should have variable speed compressor to best efficiency.
- n) *Fans and blowers* – Proper selection of a fan for a given application requires consideration of the following factors:
- 1) Required air flow (volume);
  - 2) System pressure drop at required flow;
  - 3) Operating point;
  - 4) Type of installation namely, ducted or free flow;
  - 5) Air flow configuration, for example direction of inlet and outlet flow;
  - 6) Nature of air to be handled namely, clean, contaminated or hot; and
  - 7) Space constraints.

It is recommended to select high efficiency fans and couple them with equally efficient motors (preferably high efficiency IE2/IE3 type as per accepted standard [11(34)]. Use of EC motors can also be a viable option for lower rating fans. Other factors such as type of belts (V or flat), airflow (axial/centrifugal/mixed mode), fan types (backward/forward/plug) and use of guide vanes, may be considered appropriately.

- p) *Air distribution* – The design of an air distribution system should take into consideration the factors of occupant variables and space conditions so that occupants' heat loss is maintained at a comfortable rate. Occupant variables include activity level, metabolic rate and clothing levels. Space conditions are influenced by dry bulb and radiant temperatures, relative humidity and air velocity. Various types of air distribution methodologies that may be adopted on a project are:
- 1) *Mixing air systems* –To improve the efficiency of such mixing air systems, a careful analysis of the energy savings accrued due to improved COP such as the increase in fan power should be carried out for effective implementation.

Most mixing air systems tend to be designed using a constant volume flow in the occupied zone. A good strategy for optimizing energy usage should be to examine the feasibility of incorporating a pressure independent, variable air volume system. Such systems can constantly monitor the air flow needs in any occupied zone and continuously modulate the air flow to the occupied zone.

- 2) *Variable air volume systems* – Cabins and conference areas which have partial usage may be provided with variable air volume units so that they may be operated based on the usage which further results in energy saving. Variable air volume units coupled with motion sensors enables closure of the units to the minimum levels to enhance energy efficiency.

Open areas may also be provided with variable air volume units for various zones so that the zones may be operated based on the usage. They may be actuated by a motion sensor so that the VAV will close to the minimum position in the un-occupied areas. Variable air volume unit further facilitates change of temperature set points during various seasons. Zones located in the building periphery which have the direct solar exposure should be equipped with variable air volume units.

- 3) *Displacement Systems* – In the case of displacement systems, while evaluating the primary air flow, complete mixing is not assumed. Only direct heat infiltration into the occupied space from the entire fabric load is considered for the room sensible heat evaluation. All fabric loads from walls and glazing above the occupied zone, the loads from the ceiling, lighting, etc, should be accounted for, for determining the return air heat gain. This results in significantly lower primary air requirement, leading to smaller fan and fan motor sizes. In addition, due to the higher primary air temperature, the COP of the refrigeration system may be significantly improved.

The ventilation efficiency of the displacement system is generally about twenty percent higher as compared to a mixing air system. This permits the use of lesser volumes of outside air for ventilation. As the primary air is admitted directly into the occupied zone, it shall be done at very low air speeds to avoid uncomfortable drafts. This results in low outlet velocity, low noise levels and pressure drops leading to quieter operation, improved thermal comfort, increased energy savings and improved IAQ.

- 4) *Under floor air distribution systems* – A well designed system requires less energy and is more flexible in providing and maintaining building services than traditional overhead systems. Low operational static pressures in the under floor air supply plenum may help to reduce central fan energy use. In such system, the thermal exchange with surroundings is reduced leading to better efficiency. For improved thermal comfort and maximized energy savings, it is also possible to provide under floor VAV terminal units. A ducted system facilitates the use of under floor VAV Units, particularly in perimeter zones or

- in special zones that are subject to load variations. It is desirable to insulate the under-floor to prevent thermal gain, especially if the floor below is at elevated temperatures, and also to prevent condensation on the ceiling slab below.
- 5) *Chilled beam and slabs systems* – Chilled beams and slabs are increasingly finding acceptance for energy efficient, comfortable, quiet operation in a robust system with very few moving parts and low maintenance needs. The system benefits from the increased density and energy carrying capacity of water, hence are more energy efficient than forced air systems.
- q) *Ducting* – The ductwork should be appropriately sized and balancing dampers need to be installed to reduce velocity losses. Ducts with larger cross sectional areas have much lower resistance and can reduce fan energy significantly. Duct having cross-sectional shapes such as round or oval can further reduce losses. Lower air speeds in duct reduce energy needs and noise. Ducts should be insulated and sealed but indoor air quality issues should also be considered. Factory made ducts with good workmanship may result in the lower leakage losses.
- r) *Variable speed drives* – Variable frequency drives (VFDs) are used for energy saving. These drives may be used on condenser water circulation pump (to modify the flow rate), cooling tower fans (to modulate the speed of fan during low ambient). Chillers, primary and secondary water circulation pumps set by sensing the temperature and pressure differential in the chilled water lines. Two way motorized valves in the air handling units may be actuated by a thermostat which varies the flow according to the loads resulting in pressure changes which may be sensed and used for changing the speed of the pump sets.

These drives should be used on,

- 1) condenser water circulation pump to change the flow during low load or low condenser water to optimize the plant room efficiency;
- 2) cooling tower fan to change the speed of fan during low ambient to optimize the plant room efficiency;
- 3) water cooled chillers with VFD unload more energy efficiently on part load, and; and
- 4) primary and secondary chilled water circulation pumps.

Variable speed drives are used for the air-handling units. Variable air volume units regulate the airflow for various zones based on the occupancy and temperature by a variable air volume unit, which gives a pressure signal for the VFD to change the speed of the air handling unit.

A demand controlled ventilation system uses a variable speed drive operating based on the opening and closure of the fresh air dampers controlled by the carbon dioxide sensors. A typical basement exhaust system may use a variable

speed drive controlled by carbon monoxide sensors centrifugal/screw chillers with variable speed drives.

Projects in composite climate with 24 h working schedules may incorporate free cooling systems.

- s) *Controls* – Usage of accurate/sensitive controls may save power by 10 to 20 percent. Building control system plays an important part in the operation of a building and determines whether many of the sustainable design aspects included in the original plan actually function as intended. The main objective is to improve the quality and supply of information on the air-conditioning system and to thereby reduce the operating costs. The system can establish basis which may be used as bench mark for energy efficient operation subsequently. Use of intelligent control at HVAC plant room level may be considered for efficient communication and operation of all HVAC plant room components.

### 11.9 Electrical System

Efforts should be made to select electrical installations and systems which are energy efficient, while complying with the Indian Standards for the same which provide apart from efficiency, the various other important requirements including relating to performance and safety.

The requirements for energy efficient design of electrical installations in buildings are classified under the following four categories:

- a) Minimizing losses in the power distribution system,
- b) Reduction of losses and energy wastage in the utilization of electrical power,
- c) Reduction of losses due to the associated power quality problems,
- d) Appropriate metering and energy monitoring facilities, and
- e) Reduction in losses due to usage of inefficient/old motor, replacing motors with IE2/IE3 motors as per accepted standard [11(34)].

The active energy efficiency measures include making use of energy saving equipment, low energy lighting, efficient motors, low loss transformers, efficient appliances, suitable power carrying devices and optimized electrical distribution. These active measures along with high efficiency standby emergency generating plants using diesel, natural gas, alternate fuel, etc coupled with high efficiency uninterruptible power supply (UPS) systems contribute towards sustainable development.

Passive features include good practices like simple switching off (to turn off a device when not in use), paying attention to vampire electric loads (associated with electronic appliances like computers), etc.

Some of the recommended design criteria that may be adopted are as follows:

- 1) The transformer selection may be done in accordance with minimum efficiency performance standard (MEPS).
- 2) Higher voltage distribution systems should be employed for high-rise buildings to suit the load centres at various locations.
- 3) The locations of distribution transformers and main LV switch boards should preferably be sited at their load centres.
- 4) To reduce energy losses in the conductors of cable and bus-bar trunking, their appropriate selection should be done based on voltage drop calculations.
- 5) Reduction of energy losses in the conductors of cables and bus-bar trunking may be kept in mind in the choice of conductor cross-section.
- 6) Use of bus ducts/rising mains (stacked configuration) in place of multiple runs of cables and use of dual-bus design with bus coupler is recommended for better fault current withstanding capacity, avoidance of fire hazard, and ensuring higher reliability with low energy loss in the main power distribution system.
- 7) The loss of every main circuit connecting the distribution transformer and the main incoming circuit breaker of a LV switchboard should be minimized.
- 8) The effective current-carrying capacity of neutral conductors should have ratings not less than those for the corresponding phase conductors.
- 9) The maximum loss in every feeder circuit/sub-main circuit should not exceed 1.5 percent of the total active power transmitted along the circuit conductors at rated circuit current.
- 10) The maximum loss for every single-phase or three-phase final circuit/sub-main circuit over 32A should not exceed 1.0 percent of the total active power transmitted along the circuit conductors at rated circuit current.
- 11) Any motor control centre (MCC) or motor for air conditioning installations, having an output power of 5 kW or greater, with or without variable speed drives, should also be equipped, if necessary, with appropriate power factor correction or harmonic filtering devices to improve the power factor to a minimum of 0.85 at motor and restrict the total harmonic distortion (THD). This may be achieved through use of capacitor banks.
- 12) All electrically driven equipment and motors forming part of a vertical transportation system should preferably comply with the energy efficiency requirements for lift and escalator installations.
- 13) Every motor having an output power of 5 kW or greater may be sized by not more than 125 percent of the anticipated maximum system load unless the load characteristic requires especially high starting torque or frequent starting.
- 14) A variable speed drive (VSD) shall be employed for motor in a variable flow application.
- 15) Motor users should insist on appropriate rewinding practices for any rewound motors.
- 16) Fix type capacitor should be used in capacitor bank to compensate inductive load of transformer.

- 17) The total power factor for any circuit should not be less than 0.85.
- 18) The power factor correction device should preferably be installed at the source motor control centre or distribution board just upstream of the circuit in question.
- 19) Office equipment and electrical appliances should have desired energy efficiency levels complying with relevant Indian Standards.
- 20) Consumers should be encouraged to select and purchase office machinery/equipment, for example personal computers, monitors, printers, photocopiers, facsimile machines, etc, complete with power management/energy saving feature.
- 21) Consumers should be encouraged to select energy efficient electrical appliances such as refrigerators, room coolers, washing machines, etc, complying with relevant Indian Standards.
- 22) Designers are encouraged to incorporate into their design all available latest demand side management (DSM) programmes in order to reduce the maximum demand and the electrical energy consumption in buildings.
- 23) All single-phase loads, especially those with non-linear characteristics, in an electrical installation with a three-phase supply should be evenly and reasonably distributed among the phases.
- 24) A system approach to measure and verify energy savings in the electrical distribution installations in buildings (especially high rise and commercial ones) should be adopted.
- 25) Wherever conventional fossil fuel based captive generation systems are deployed scoping for heat recovery systems, including tri-generation, may be explored.
- 26) To achieve peak demand avoidance programmable logic controller (PLC) controlled automatic electrical distribution systems should be opted for.
- 27) Consumers should be encouraged to use IE2/IE3 motors in line with accepted standard [11(34)] and replace old inefficient motors with the mentioned standard. They should be encouraged to replace the motors rewound more than 4 times.
- 28) Air handling units should use energy efficient motors.

## **11.10 Lighting**

Lighting has a significant impact on building loads and energy usage. The lighting design should focus on providing high quality visual environment with an emphasis on energy efficiency. With efficient lighting technologies and moderated interior illuminance, it is possible to design high quality lighting at connected power level that are much lower than that in a conventional building. Renewable energy sources should be emphasized for lighting in the outdoor having access to ample sunlight.

### **11.10.1 Daylighting and Controls**

The optimal use of daylight shall be made to reduce the load of the electric lighting system by dimming or switching off luminaires when natural light provides ample illuminance for



the task performed in the space. Daylight harvesting has a significant energy saving potential if it is integrated with the building design after comprehensive understanding of site, building orientation, weather conditions, materials and system design. Design for daylighting shall be done in accordance with Part 8 'Building Services, Section 1 Lighting and Natural Ventilation' of the Code. It is recommended to explore use of automatic light controls like those based on occupancy, timer, and dimmer.

### **11.10.2 Artificial Lighting**

Lamps, luminaries, ballasts and the controlling systems should be monitored for achieving energy efficiency through artificial lighting. Factors that play crucial role in designing an energy efficient lighting system are:

- a) Reflectance,
- b) Design of interior spaces,
- c) Efficiency of lighting systems,
- d) Task lighting,
- e) Controlling systems, and
- f) Monitoring and maintenance.

Reference may also be made to the National Lighting Code.

## **11.11 Lifts, Escalators and Moving Walks**

### **11.11.1 Elevators**

With the growing influx of urban dwellers and rising sea levels, developers are constructing high rise buildings, creating the need for incorporating vertical transport in the infrastructure. Installing elevators and escalators makes mobility convenient, especially for people with disabilities. These vertical conveyances are the marvels of engineering, shuttling passengers and freight, up and down hundreds of stories. While the traditional rope and pulley systems have existed for hundreds of years, many companies have now begun to explore a wide and somewhat outlandish array of alternatives due to increasing concerns about the environment. An elevator inside a typical skyscraper might weigh around 30,000 Kgs and hoisting all that mass requires tremendous amount of energy.

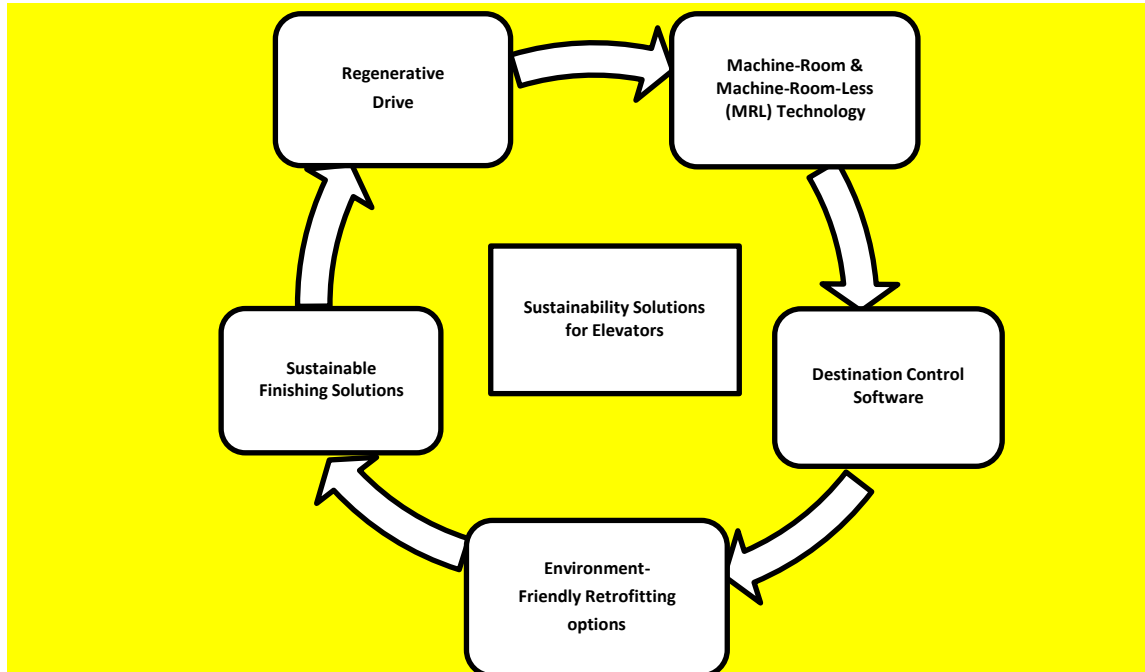

**Fig. 28 Sustainability Solutions for Elevators**

Considering half of the world's population living in cities, the energy demand is already huge and is expected to increase significantly. Therefore, efficient vertical transportation can become a pressing challenge. For this purpose, various new technologies have been introduced to reduce energy usage of buildings and contribute to the effort of cities in lowering their energy consumption. One of the most sustainable solutions that can result in efficient vertical transport are green elevators (see also Fig. 28).

The eco-friendly elevators operate with much less energy and require relatively less building space for installation, and thus play a major role in the growth of green buildings. Here are some of the green strategies adopted in elevators to lower energy consumption and make them sustainable.

#### **11.11.1.1 Regenerative Drives**

Of all the recent upgrades, regenerative drive technology has been one of the significant innovations in the latest generation of energy efficient elevators. Advantages of regenerative drives and measures to be taken for dissipating regenerated energy are given in 8.4.3 of Part 8 'Building Services, Section 5A Lifts' of the Code.

#### **11.11.1.2 Machine-Room-Less (MRL) Technology compared to hydraulic elevators**

Manufacturers redesigned motors and all other equipment housed in a traditional machine room to fit into the hoist way, making some space-saving improvements to eliminate the need to build a separate machine room. MRL technology enables less heat dissipation and energy consumption than the larger versions previously used. The door

drive motors can enter a standby mode or efficiently recover from the removal of power when not in use and support variable door-open and close times. Thus, the factored energy usage supports the overall control strategy. The power feeders for MRL are significantly reduced to a more compact design, eliminating the cost and environmental concerns associated with hydraulic cylinders. The MRL elevators utilize gearless traction type machines that results in superior performance as they operate at faster speeds and increase the perception of quality in comparison to conventional hydraulic elevators.

#### ***11.11.1.3 Destination Control Software***

As buildings are getting taller, there is a growing need to optimize lift operations to reduce the time to destination. The efficient elevator destination control system allows authorized users to enter the designated elevator only. Unlike conventional elevator control system that only registers the desired travel direction, the Destination Control Software (DCS) incorporates the desired destination floors and number of waiting passengers to improve elevator convenience. The significantly improved system operation results in increased efficiency for building owners, enhanced comfort, reduced journey time for passengers, improved security and peace of mind for residents. Prior information about the number of travelers and their destination floors through destination software results in short transits and fewer intermediate stops. Since skyscrapers have multiple floors, the DCS organizes groups of passengers traveling to a few specific floors in one trip rather than stopping at multiple floors for various individuals. The energy saving due to reduced number of elevator trips is a positive change along with the reduced user-wait-time and increase in handling capacity by up to 30%.

#### ***11.11.1.4 Environment Friendly Retrofitting Options***

Replacing all the incandescent light fixtures in old elevator units with LED lamps is one of the simplest ways to reduce energy consumption. LEDs use only 4% of the energy when compared to traditional bulbs. Besides overhead car lighting, even buttons and floor lights can be replaced with LEDs which reduces cooling load and saves energy. Moreover, substituting DC controllers with energy-efficient AC controllers can further help to minimize heat generation. Also, traction and hydraulic elevators use hazardous lubricants that may accidentally leach into the ground water supply. These black lubricants can be replaced with eco-friendly solutions such as minerals, vegetables and non-petroleum based synthetic oils.

#### ***11.11.1.5 Sustainable Finishing Solutions***

Replacing interior finishes with low volatile organic compounds (VOCs) and other sustainable finishes can improve the indoor air quality significantly. Some materials that are typically used in the elevators can start off-gassing (release of chemicals into atmosphere via evaporation) within a few months of installation that can result in harmful breathing atmosphere and lead to allergic reactions, headaches, and migraines. So, it is best to install low-VOC coatings, sealants, and adhesives to ensure enhanced indoor air quality. Bamboo flooring, linoleum rather than vinyl composite tiles (VCT), recycled and

cradle-to-cradle (C2C) carpets and wall coverings are some of the sustainable material possibilities derived from renewable resources and recycled products.

#### **11.11.1.6 Remote Monitoring and Maintenance**

Many green elevators come equipped with remote monitoring systems that enable real-time monitoring of elevator performance. By proactively identifying issues, such as malfunctions or component wear, technicians can perform timely maintenance, reducing downtime and increasing elevator efficiency.

#### **11.11.1.7 Sustainability and Life of Elevators**

From sustainability point of view, the design life of an elevator should ideally be equal to that of the building where it is provided. This of course, presumes proper use of the elevator, its diligent maintenance, replacement of components (whose life expectancy may be less than that of the building), and other critical upgrades to enhance safety/performance as necessary. Since an elevator is a system of several components/machines/sub-assemblies/sub-systems working in a coordinated manner, the life expectancy of each of them could be different. On the other hand, there are components which could last much longer than the expected life of the building, e.g. guide rails, buffers, counterweight, steel items of the car and car-sling, doors, etc.

Thus, the above approach, as against the practice of replacing complete elevators after a few years, contributes to 'responsible consumption and production' and "making cities sustainable by having safe and affordable housing" the sustainable development goals.

#### **11.11.1.8 Escalators/Moving Walks**

VVVF drive system shall be used enabling different modes of operation such as rated speed and reduced speed from energy saving point of view.

Manufacturing processes such as chemical etching in stainless steel for obtaining deep grooves in comb plate and landing plate shall be avoided. Instead, it is recommended that comb plate and landing plate be made from grooved aluminum extrusion profiles, or punched stainless steel cover may be used.

Electrical power supply backup from UPS should be restricted to comb light, direction/traffic light, and step gap light only. Further, it is recommended to provide the back-up supply from the centralized UPS system of the building infrastructure to the extent possible. This will avoid generation of hazardous waste from the batteries of stand-alone escalator UPS.

Use of IE2 motors as per the accepted standard [11(34)] and helical gears can improve installation efficiency.

The planning, design and installation of lifts, escalators and moving walks shall be done in accordance to the Part 8 'Building Services, Section 5 Installation of Lifts, Escalators and Moving Walks' of the Code.

To minimize the environmental impact, the materials used for manufacture of lifts, escalators and moving walks should be recyclable, shall not have a potential for depleting ozone layer, shall not be hazardous, and shall be easily disposable at the end of life cycle. As power consumption during utilization phase has the maximum environmental impact, lifts and escalators to be installed shall be energy efficient.

In case of high rise buildings with multiple lifts having peak traffic demand, to increase the efficiency, the destination control system wherein passengers key in their destination before entering the elevator, which optimizes the number of trips made by the lifts, may be installed. The controller groups the people such that the stops are minimized and travel time reduced.

Electrical traction lifts should be preferred over hydraulic lifts. Use of high efficiency motors such as Permanent Magnet Synchronous Motors, or Induction motors having minimum efficiency class equivalent to IE2 as per accepted standard [11(34)] is recommended. The brake liner material should be environment friendly.

It is also recommended to provide lifts with regenerative drives. The efficiency of the drive in both motoring and generating mode should not be less than 0.8. LED lights should be preferred for illumination.

The planning, design and installation of lifts and escalators shall be done in accordance to the Part 8 'Building Services, Section 5 Installation of Lifts, Escalators and Moving Walks' of the Code.

### **11.12 Good Installation Practices**

For installation of equipment and other installations, good installation practices with stringent quality control measures should be followed which also results in easy maintenance and energy saving, subsequently.

### **11.13 Commissioning and Handing Over**

Commissioning is a systematic process to ensure that the installed systems perform according to the design intent and the owner's operational needs. A commissioning plan should be created early in the design phase. The readings should be logged and tabulated properly. The operation and maintenance staff shall be adequately trained by qualified personnel so that the staff has all the information and skill needed to optimally operate and maintain the systems. Operation and maintenance manuals with as-built drawings should be obtained from the contracting agency/agencies.

### **11.14 Operation and Maintenance**

The operation and preventive maintenance schedule should be diligently complied with. Operation should be specially focussed, from sustainability point of view, in areas which

can result energy saving. Such savings shall be aimed at without compromising the design intent.

### 11.15 Ongoing Performance

Regular maintenance and cleaning, periodic calibration, monitoring emissions and leaks, purge operation, record keeping, proper refrigerant levels, etc, help in continued peak performance of operation.

### 11.16 Renewable Energy

All efforts should be made to utilize in the building, the renewable energy available in various forms. Following aspects may be considered for the purpose:

- a) *Solar energy utilization* – Solar energy may be utilized in building through the following applications:
  - 1) *Solar water heating systems* – Hot water requirement in buildings may be met through use of various types of solar water heating systems. Major types of water heating systems are:
    - i) Flat plate collector: Single glazed, double glazed;
    - ii) Evacuated tube collectors; and
    - iii) Water heating with solar concentrators.

Considering the possibility of overcast conditions, or maintenance of collector, etc, the solar water heating system should be fitted with auxiliary heating system using conventional sources of energy such as electricity or gas. Application of auxiliary heating should be determined in such a way to avoid heating of excess amount of water. For example, if the heating is provided in a tank, it keeps the entire amount of water at the set point temperature, irrespective of the requirement/usage, resulting in wastage of energy.

In case of buildings where roof area is not sufficient to cover entire requirement of solar water heating, especially in case of high rise buildings, solar concentrators may be used for focusing solar energy over smaller area.

Decision about single glazed, double glazed, evacuated tube, concentrating type, etc, shall be done as per the local site conditions, solar radiation, ambient temperature, wind velocity, shading of neighbouring buildings and other similar features.

Capacity of such systems should be determined as per the average requirement instead of peak requirement, as the later increases the investment involved and reduces the financial payback period.

- 2) *Solar steam systems for cooking, laundry, etc* – Steam can be generated on the roof top of buildings through use of solar concentrators. Steam generated through such concentrators can be used to meet requirement of steam in buildings such as for cooking and laundry, and to meet the energy demand for other applications such as for heating/preheating of air and disinfection/sterilization of instruments. Specifications of such systems shall be determined according to availability of solar radiation, size and concentration ratio of the concentrator, ambient temperature, and steam storage for operation during off-sunshine hours. Wherever such systems are used/installed, attempts should also be made to recover condensate or warm water after its application.
- 3) *Solar assisted refrigeration/air conditioning systems* – It should be also attempted to utilize solar energy to operate vapour absorption or vapour adsorption based refrigeration/air-conditioning systems. Similar to solar water heating systems, such systems may also be designed with auxiliary heat supply provisions so that they may also operate during overcast days.
- 4) *Solar photovoltaic systems* – Solar photovoltaic (PV) systems are direct energy conversion systems that convert solar radiation into electric energy. Roof of buildings as well as other exposed areas such as of parking shade, can be installed with solar PV system. Major considerations while designing a building integrated PV system are:
  - a) Sufficient spacing between consecutive rows of modules as per the sun-path diagram;
  - b) Inclination of modules to match requirements as per latitude;
  - c) Periodic cleaning of dust from the cover of modules;
  - d) Matching of specifications of PV modules, array, power conditioning unit (PCU)/inverter, battery storage and wiring; and
  - e) Checking of operating point of PCU/inverter, depth of discharge of batteries.

Components of solar PV systems and factors of performance are as follows:

- i) *PV modules* – These contain solar cells. Efficiency of cells and module should be as high as possible. Currently, cells having 16 percent efficiency are commonly used and suggested.
- ii) *Charge controller/inverter/PCU* – It is part of PV system that matches the output of PV modules with acceptable form of electricity by battery bank or load or grid. Since considerable power

loss may take place in this unit, efficiency of inverter/PCU should be more than 90 percent at full load and not less than 85 percent at 25 percent load.

- iii) *Battery bank* – It is where energy can be stored in batteries for use during off-sunshine hours. When operating in stand-alone mode, usually additional one day energy storage capacity is provided in the battery bank. Location and type of batteries should be such that they do not affect indoor air quality. If kept indoor, the space should be sufficiently ventilated with fresh air with no recirculation of air.
  
- b) *Wind energy utilization* – If sufficient wind velocity exists at the site, it should be attempted to make use of available wind velocity through installing wind turbine for power generation. Usually wind velocity increases with height, hence wind turbines may be installed on the roof of high rise buildings or between two buildings causing Venturi effect due to their shapes, with due care towards structural safety considerations. Hourly wind data of whole year at the site should be the basis of machine selection, and not just wind velocity during few days of the year.

Annual power output from the turbine should be more than power output equivalent to full load output for 20 percent of the whole year. However, exact number in this regard shall be governed by the cost of wind turbine, cost of electricity and other case specific variables.

The visual disturbance caused by the rotating wind turbine, acoustic disturbance to neighbouring area and to occupants of buildings should be considered while selecting machine and its location.

At some locations where wind and solar radiation both are available, and especially when wind is available during the time when there is no or less solar radiation, hybrid wind-solar PV systems can also be considered. Wind energy systems may also be operated in hybrid mode with other sources of electricity such as diesel generating (DG) sets to ensure availability of power throughout the year.

- c) *Waste utilization* – It should be attempted to make full utilization of all wastes, especially waste heat and bio-degradable solid waste.
  - 1) *Waste heat utilization* – Waste heat available from different sources such as exhaust gases and cooling water of electricity generators, or any other process going on in the building that discharges solid, liquid or gaseous hot waste, may be utilized directly through heat recovery methods for heating applications such as space heating, service hot water, etc. Alternatively, the waste heat available can also be utilized for operating vapour absorption or vapour adsorption refrigeration/air conditioning systems.



- 2) *Solid waste utilization* – Bio-degradable solid waste generated within the building, such as kitchen waste, human excreta, branches and leaves of trees, grass cuttings should be utilized through anaerobic digestion process to produce combustible gas. This gas may be utilized to replace some fuel requirement in the building. Manure is a by-product of such bio-gas digester that may be used to improve the economics of utilizing solid waste. Other alternatives of anaerobic digestion, such as briquetting for direct combustion, gasification may also be used as per properties and availability of solid waste.
- d) *Bio-fuels* – The term bio-diesel or bio-fuels is usually referred to liquid fuels that are not obtained from fossil based sources of energy such as crude oil, but are obtained from plant species.

In case of buildings where open space is available, attempts should be made to grow such plants and use their oil to substitute some of the conventional fuel. For example, DG sets may use a blend of bio-diesel and diesel or may even operate on 100 percent bio-diesel.

Similarly, other possibilities of obtaining combustible fuel, such as from vegetable waste oil of restaurants and hotels should also be explored and utilized, wherever possible.

- e) *Hydropower* – The flow of tides of an ocean or a stream is harvested to produce hydropower. As the water is released from the upper reservoir to the lower reservoir it generates power using the hydro-kinetic energy of the water flow through a generator. The ability to use hydropower is limited on an individual building scale. On rare occasions, buildings can take advantage of streams to generate hydropower on site.
- f) *Other renewable energy sources* – Depending upon climatic location and site specific features, possibility of exploiting other renewable energy sources, such as, geothermal heating and cooling systems should also be considered.

## 12 CONSTRUCTIONAL PRACTICES

The framework for sustainable construction practices includes the following issues:

- a) Pre-construction pre-requisites;
- b) Planning for sustainable construction;
- c) Preparation of sustainable construction management plan;
- d) Planning, monitoring and control of environmental descriptors;
- e) Sustainable work execution procedures;
- f) Effective use of water;
- g) Construction waste management ;
- h) Post-construction closeout;

- j) Construction methodology for heritage buildings; and
- k) Alternative use, de-construction, dismantling, demolition.

## 12.1 Pre-construction Pre-requisites

Sustainable construction bears upon developing the design proposal, which is efficient in terms of functional performance as well as detailed out to ensure that the material resources and construction technologies are used efficiently during construction stage. Frequent changes to the design during construction stage often lead to wastage and other resources, rework and redundant handling and construction processes. Construction practices to execute design proposals, which inherently cause higher wastages and do not facilitate efficient planning, should be avoided. The pre-construction stage proposal development should incorporate certain pre-requisites that lead to sustainable construction practices (*see also 12.4*).

### 12.1.1 Architectural and Structural Design

Architectural design should be detailed out so that use of materials and technologies may be planned in advance. Design detailing should facilitate planning of procurement of materials in sizes, volumes and lots, such that the wastage during construction is least. It is desirable that the design is consistent with the available material sizes, shapes and volumes. Design should, therefore coordinate to incorporate quality and quantity aspects from the point of view of construction.

Design detailing should facilitate procurement process. Storage of materials at site for unduly long period may adversely affect its quality and short supply may lead to interruptions in interfacing activities. Thus, the efficient procurement process ensures optimum procurement.

Structural design is critical in ensuring optimum use of materials. Inadequate rigour in design analysis can lead to over-sizing of structural members, while uncertain quality assurance and control may render structural members unsuitable due to permanent construction defects.

It may be desirable to develop building designs through digital models so that the dimensional coordination and interfacing between architectural, structural and engineering services is ensured with an aim to avoid improper execution during construction stage. Application of 'modular coordination' is desirable in mass repetitive construction works especially using mechanized or industrialized construction techniques.

Drawings generated as 'good for construction drawings' shall be reviewed for coordination across various disciplines before their release for construction. Coordination between architectural drawings, structural drawings and engineering services (mechanical, electrical, plumbing) drawings, etc, shall be assessed in plans and sectional details. It may be desirable to undertake three-dimensional clash analysis using

appropriate information technology tools and software. Therefore, all efforts should be made at design stage to ensure that the time and resources are not wasted during construction stage work.

#### **12.1.2 *Inclusion of Sustainable Construction Needs in Feasibility Report***

Feasibility report directs planning, design and execution of a project. It acts as a reference boundary for the project within which the project is viable. It details out the manner in which objectives of the project are achieved. Project requirements shall be accomplished within the planned resources. In light of the significance of feasibility report, it is essential that the sustainability objectives, both in terms of operational phase of the project as well as the construction phase, should be highlighted. As a result of that, the resources, technical procedures and benchmarks may be established for execution to be viable within the overall sustainability parameters of the project.

Specifically, benchmarks for the energy consumption, water utilization, waste generation, reuse of waste generated during construction and operation phase should be established in the feasibility report for sustainable construction.

#### **12.1.3 *Construction Methodology***

For sustainable construction practice, it is essential that the physical execution of works should only be undertaken when the construction methodology is established, and reviewed for its reliability under the risk environment that may prevail under specific conditions of the project. Construction methodology details out process of execution, its work flow, deployment of various resources, planning for eventualities and contingency measures. In absence of an established sustainable construction methodology, the efficacy of work procedures may not be ensured.

It is desirable to evolve construction methodology on digital models so the physical developments at site may be simulated under working conditions. Information tools that identify inter-disciplinary clashes are identified. In many a cases, it may be necessary to plan in a predetermined manner for the structural considerations, failing which the stability may be jeopardized. It is essential for construction works that involve a fair amount of pre-fabrication, especially off-site, so that the fabrication is compatible and the installation procedures are fail-safe during the installation as well until the stage when structure is capable to endure itself independently.

#### **12.1.4 *Mitigation of Impacts Due to Materials and Technologies Deployed***

Construction materials and technologies used at site may impact the environment, especially during processing of materials, such as cutting, mixing, fabrication, etc causing noise, dust and sometimes release of fumes. Such materials and technologies need to be identified and procedures planned to mitigate impacts.

#### **12.1.5 *Deployment of Plants, Equipment and Machineries***

Selection of efficient plants, equipment and machineries and their proper scheduling of operation are key considerations for sustainable deployment. While selection, it is essential to ensure that plants, equipment and machineries have their performance ensured not in isolation but also when considered in relation to the supporting plants, equipment and machineries. For example, the selection of excavator of a certain capacity is linked to the availability to earth transportation out of site and the clear working space available for the excavator and the transportation vehicles. Having selected an optimum set of plants, equipment and machineries, it is essential that their operation is scheduled such that their combined performance is maximized. Failure to deploy plants, equipment and machineries in an efficient and effective manner may result in undesirable loss of fuel, and noise and air pollution.

#### **12.1.6 Procurement Policy**

In order to ensure sustainable construction, the organizations involved should have a resolve and commitment to procure processes, services, works and supplies that help in achieving the objective of sustainability. Since sustainability is project and context specific, the policy should entail requirements in respect of sustainability pertinent to the project.

#### **12.1.7 Contractual Obligations towards Sustainable Construction**

Contracts determine obligations of individuals and organizations. In this respect, the contracts shall make it obligatory on the part of the supplier (materials, equipment or services) to follow sustainable practices and processes. The scope of such obligations shall include the relevant issues described under **12**. Contractually binding obligations ensure system-wide responsibilities so that necessary mitigation resources may be budgeted within the project scope.

#### **12.1.8 Assignment of Responsibility for Sustainability Practices During Construction**

The responsibility for sustainability practices during construction shall be clearly assigned, also explicitly assigning liabilities that may accrue on account of lapses. This strengthens the responsibility delegation and also act as deterrent for slackness while discharging duties. Liabilities may include contingencies for risks known as well as management reserves towards unknown risks.

### **12.2 Planning for Construction**

Pre-construction pre-requisites are important inputs to the planning for construction in a sustainable manner. Planning processes describe the approach towards the construction. A proper planning, considering peculiarities of project, helps ensure successful execution. The planned processes towards sustainable construction may be far more effective than spontaneous actions taken without comprehensive planning at early stages. Also, cost

for mitigations and possible alternative strategies for mitigation may be better analyzed for arriving at managerial decisions.

### **12.2.1** *Identification of Sustainability Issues During Construction*

The procedure to identify sustainability issues during construction should include the areas of analysis given in **12.2.1.1** to **12.2.1.5** and other applicable concerns in respect of project scope and context of site and environment.

#### **12.2.1.1** *Construction methods review and impact on sustainability*

Design details determine the construction procedures. It is desirable to prepare a construction methodology and review the same from the point of view of its impact on the suitability to achieve quality, control of wastages, safety, resource optimization, energy conservation, water use, site contamination and pollution.

#### **12.2.1.2** *Consideration to environmental impact assessment*

Environmental Impact Assessment (EIA) report systematically identifies the risks and impacts and recommends mitigation measures. Framework of EIA is defined in accordance with the statutory requirements and, hence, it is essential to consider the impacts so identified. Construction methodology and processes shall take cognizance of EIA report and environmental management plan (EMP).

#### **12.2.1.3** *Considerations to social impact assessment*

Construction activities have significant impact on the socio-cultural interests of the populations surrounding the project sites. Continuance of human activities, especially related to their economic sustenance, livelihood and socio-cultural aspects, need special sensitivity. Dealing with social impacts during construction stage need managerial decisions to provide privileges to the affected populations and undertake actions to contribute towards deployment of social infrastructure. Such initiatives should be planned for.

#### **12.2.1.4** *Prevention and management of construction accidents*

Accidents shall be prevented during construction stage. Construction teams shall analyze potential hazards and plan for their prevention and management. Accidents may endanger life of workers and population in and around the sites, cause disruptions to work and lead to loss of material and other resources. Efforts in prevention of accidents is often insignificant as compared to the problems in facing consequences. Deep excavation, scaffolds, shuttering and hoisting operations are known to be prone to accidents at sites. In addition to the accidents that may be caused due to the activities on site, there may be environmental conditions that may cause accidents during construction works since works may not have attained the stage of adequate stability and endurance to counter the impinging environmental conditions. Accidents due to floods, landslides, cyclones,

high winds and earthquakes may need special attention requiring proper disaster preparedness (see also 12.11).

#### **12.2.1.5** *Identification of training needs and workforce training*

Sustainable construction practices require specific processes to be followed in respect of planning, monitoring and control. Involvement of workforce at all levels need training to deal with sustainability issues during construction. Project management functional responsibilities shall include identification of processes, competencies of persons involved in discharge of such duties, assessment of performance and conduct training programme. The effectiveness of training programme shall be assessed through performance appraisal system and corrections made as needed. Training need assessment frequency should be determined based on the type of work and the human resource competencies.

### **12.3 Preparation of Construction Management Plan**

Having identified sustainable issues specific to the project, a comprehensive planning needs to be documented in a management plan. The management plan documents the approach to site management, project management processes, systems for management, site organization, data inputs to determine effectiveness of management systems and site planning.

#### **12.3.1** *Establishment of Construction Project Management Processes*

Objectives of sustainable construction can only be realized through effective project management processes. Time, cost, quality, scope, risk, procurement, human resource, health and safety are some of the basic project management processes that shall be elaborated. Reference should be made to good practices [11(29)] for detailing out construction project management processes.

#### **12.3.2** *Establishment of Management Systems*

Management systems define organizational commitment, organizational structure, resource allocation, relevant critical planned processes, procedures for monitoring and control to ensure continual improvement. The approach of management systems is preventive with an objective to achieve excellence in terms of absence of non-conforming works. Management systems approach sustains on documented voluntary initiatives, due monitoring thereof, and the same way be considered. Reference should be made to appropriate Indian Standards for developing and complying the above systems.

#### **12.3.3** *Establishing Site Organization Structure*

Establishing site organization structure, considering management systems and involvement of other agencies in construction, is very critical. Interfaces across various agencies involved in construction need clarity for effective coordinated decisions which

can lead to prevention of wastage of resources, reworks, rejections, delays and such other non-conformities detrimental to quality of work and delay in execution.

#### **12.3.4** *Establishing Energy Consumption Data Collection, Analysis, Documentation System and Creating Benchmarks*

Monitoring of performance of management systems and processes of execution need establishment of indicators so that specific improvements may be achieved. In this respect, energy consumption monitoring is fundamental. At construction sites, electricity and diesel are primary sources of energy and their consumption shall be monitored so as to improve methods and the operation of equipment is energy efficient. Data collected should be analyzed with respect to processes of significance in terms of consumption and pollution. Database so generated can also be used for establishing project specific, organization specific or process specific benchmarks for future reference. Appropriate documentation of fuel consumption logs, energy metering and execution processes shall be planned and assigned organizational responsibility. Site management decisions shall take cognizance of energy consumption data.

#### **12.3.5** *Overall Construction Site Planning*

Improper site planning is often reason for redundant material handling, processes involving unnecessarily long lead, wastage during multiple handling, inefficient deployment of equipment, etc. Circulation and movement of workers and visitors can be reason for unsafe working conditions. Following issues, therefore, need specific attention while undertaking site planning:

- a) Layout of roads and services;
- b) Deployment of plants, equipment and machineries;
- c) Location of temporary structures, fabrication area and storage areas;
- d) Work area demarcation and safe surrounding;
- e) Emergency plan and medical facility;
- f) Control of site dereliction;
- g) Prevention and management of top soil; and
- h) Storage of chemicals, fuels and explosives.

#### **12.3.6** *Location of Infrastructure for Labourers*

Labour is at the bottom of the organizational structure of construction practices. Project organizations may tend to ignore the interests of labour and tend to be indifferent to their needs. Indifferent and ignored labour, on the other hand, can cause inherent inefficiencies in the system and lead to unreliable performance. Infrastructure for labour needs to be planned and budgeted suitably considering the following:

- a) Compliance to labour laws including *Building and Other Construction Workers (Regulation of Employment and Conditions of Service) Act, 1996*;
- b) Policy and location of labour camps;

- c) Policy for deployment of labour from local communities;
- d) Labour movement;
- e) Social infrastructure for labour;
- f) Health, hygiene, amenities and waste disposal; and
- g) Training need assessment, training infrastructure and effectiveness monitoring.

### **12.3.7 *Setting Up of Health and Hygiene Infrastructure***

Health and hygiene infrastructure is needed for the construction site as well and the labour infrastructure, especially if labour camps are off site. In addition to the construction project specific injury and emergency treatment facilities, facilities shall be provided for conducting periodic health check-ups for the workers so that the effects of construction activities on the health are monitored. Medical facilities shall be established with suitable expert physicians and paramedics, availability of appropriate medicine supplies, diagnostic facilities and organized record keeping.

As a part of hygiene infrastructure, potable water supply, waste water disposal and solid waste disposal (non-construction) are planned in a proper manner. In order to determine the standards, the needs of vulnerable groups, such as children, shall be considered.

### **12.3.8 *Location of Facilities for Hazardous Materials***

In special cases, the facilities for storage of hazardous materials may be provided very carefully. There may be a case for locating such facilities off-site. Specific statutory guidelines in respect of such requirements shall be referred to. The facilities and the handling procedures shall be well established.

## **12.4 Planning, Monitoring and Control of Environmental Descriptors**

Environmental impact assessment (EIA) undertakes characterization of the existing status of the land, water, air, biological and socio-economic environment in the project area and its surroundings. It seeks to identify potential environmental impacts of the project, and formulation of an effective environmental management plan (EMP) to prevent, control and mitigate the adverse environmental impacts, and ensuring the compliance with the environmental legislations. Thus, the scope for planning, monitoring and control of environmental descriptors during construction phase is identified and described in the EIA and EMP. Construction agencies shall develop further and detail out their respective compliance requirements accordingly.

Depending on the nature of project, construction agencies shall be required to establish infrastructure and procedures for soil monitoring, water quality monitoring, ambient air quality monitoring, noise monitoring, tree counting and traffic survey, with a view to having required controls thereon.

### **12.4.1 *Soil Monitoring***



Soil samples from representative locations in the site and study area shall be collected and analysed for important relevant physical and chemical parameters. Soil monitoring should be carried out in at least three locations including one at the project site.

#### **12.4.2** *Water Quality Monitoring*

Water quality monitoring shall be conducted at representative locations in the study area for surface and groundwater. Samples shall to be collected and analysed for important relevant physical, chemical and bacteriological parameters. Water quality monitoring locations should include at least three surface water (if exists in the study area) and three groundwater locations.

#### **12.4.3** *Ambient Air Quality Monitoring*

Depending upon the project size, location and the type of activities involved, ambient air quality in respect of suspended particulate matter (SPM), respirable particulate matter (RPM), SO<sub>2</sub>, NO<sub>x</sub>, and CO, shall be monitored at representative locations in the site and study area at a frequency of twice a week at each location adopting a 24 hourly schedule (8 hourly for CO). The monitoring locations shall be located on the basis of predominant wind directions, land use pattern and height of the proposed stacks. At least one station shall be located at the maximum pollution deposition area due to the proposed stacks of generators. The number of air quality monitoring locations should be at least five including one at the project site.

#### **12.4.4** *Noise Monitoring*

Ambient noise level monitoring shall be carried out at representative locations in the site and study area over a period of 24 h to obtain hourly equivalent continuous noise ( $L_{eq}$ ) levels as well as day and night time  $L_{eq}$  to compare with the standards. Noise monitoring should be carried out for at least six locations including one at the project site, one at the boundary of the project site and one at the nearest residential/sensitive area.

#### **12.4.5** *Tree Counting*

Survey shall be conducted to assess existing trees in the project site in respect of numbers, species girth size, plan for re-plantation or making good for trees being lost to be finalized.

#### **12.4.6** *Traffic Survey*

Traffic survey for continuous 24 h has to be carried out to measure number and type of vehicles passing on the existing main roads giving access to the project.

### **12.5 Work Execution Procedures**

Work execution procedures should be described in a manner so that there is least wastage, rework and repair and acceptable performance is achieved. In this respect, the reference to relevant Indian Standards for materials; quality assurance verification; material handling, storage, and protection; work procedures including working on materials/fabrication, placing/installation; inspection and testing procedures of completed works; and protection after completion of work, need to be specifically addressed. In addition to these considerations, the relevant works should be given specific attention as given below:

- a) *Excavation and sub-structure works* – Issues related to noise and vibrations during excavation, piling, rock cutting, etc; control of damages to surroundings; prevention of collapse; and, control of excessive dewatering and sustainable use of de-watered water need to be analyzed, risks identified and methodologies detailed out prior to undertaking such works.
- b) *Concrete work procedures* – Soundness and stability of formwork and other enabling structures; suitability of concrete mix to the prevailing environmental conditions; avoidance to undesirable cutting, etc for laying services and embedded items; providing requisite cover to the reinforcements; proper curing; and, allowance of setting time are essential for meeting the expected performance of concrete works. In general, for concrete works, good practices [11(30)] shall be followed.
- c) *Steel, aluminium and other metal works* – Noise control during cutting, welding, hammering and fabrication operations; prevention of waste; reuse of cut sections (for example cut reinforcement bars reused in other locations depending on requirement); collection and disposal of scrap; fire and injury prevention during working; prevention of collapse due to unstable installation operations; and safety of workmen are critical aspects that need special mention in procedures.
- d) *Masonry works* – Wastage during on-site handling of materials; execution in proper plumb, plane and alignment to avoid wastage of finishing material for making up for making up for the defects; and, filling up of joints to attain requisite *U* and *R* value characteristics need particular attention.
- e) *Surface finishing and furnishing* – Preparation of finishing base; environmental conditions during and after finishing/furnishing works; and, application procedure for surface undulations are essential considerations to realize desirable surface characteristics as well as service life of finishes and furnishings.
- f) *Handling and use of chemicals* – Working conforming to the prescribed procedures; protection against spillage and human body contact; supply and use log describing quantities and authorized person(s); and, prevention of reaction which are explosive, exothermic causing fire or release of toxic fumes

or creating corrosive reactions to the surrounding works, should be specifically identified and planned.

- g) *Handling and use of oils and gases* – Avoidance of fire by preventing conditions leading to ignition; spillage polluting the works and sites; use of appropriate containers for storage and handling; and contingency procedures for limiting damage due to spillage and neutralizing the effects should be specifically highlighted in procedures.

## **12.6 Effective Use of Water – See 10.4.**

## **12.7 Construction Waste Management**

**12.7.1** Construction and demolition activities generate large quantities of solid waste. Diversion to landfill sites is one of the major issues in handling of construction waste. Increase in waste generation and improper land filling with construction wastes have major impacts like waste of land resources, affecting water bodies, groundwater pollution, etc. Construction organizations shall systematically pre-empt and identify wastes that may be generated and plan to re-use, re-cycle and handle wastes in an appropriate manner. Monitoring of waste and its disposal through an established procedure also create opportunities to prevent wastages in construction processes and lead to conservation of resources.

By proper disposal, waste materials which are likely to be dumped in landfills can be converted into value added products. Some construction waste materials can be diverted for re-use, whereas others can be recycled into another usable material. Many construction waste materials can either be used onsite or sent to other nearest sites/industries for reuse/recycle/reconversion into useful products.

One of the important approaches to reduce waste and effect waste utilization is to evolve design details such as optimizing use of materials and employing technologies aiding in the same. Durable materials and high performance technologies need lesser maintenance and deliver better service life. Proper construction waste planning is, therefore, recommended before starting the construction or demolition which involves identification, segregation, proper storage, reuse/recycling and finally the proper disposal of remnant waste materials.

### **12.7.2 *Identification, Segregation and Storage of Wastes***

It is very difficult and costly to reuse or recycle the waste materials which is in mixed form and not segregated at right time during the construction. Storing of segregated waste in labelled containers/bins, and monitoring of stored waste bins periodically by the trained/skilled personnel may prevent wastage. Waste should be stored within the site and such area should be chosen, where further shifting is not required.

### **12.7.3 *Reuse and Recycling***

Reuse and recycling not only reduces the land filling load but is also economical and an eco-friendly step in construction. Reuse increases the life of building materials. It is desirable to locate nearby recycling units for construction waste recycling to reduce the cost as well as adverse environmental impact.

Brick bats and concrete, especially from piling works, have a potential to be used as sub-grade works for paving, etc. Excavated earth and boulders may often be reused at site or used elsewhere through the network of specialist agencies. However, topsoil should be isolated, preserved and reused at the same site or at another location where there is a demand for fertile topsoil for landscaping. Wastes, such as metal and plastics, should be disposed of for re-cycling. Other wastes, such as cellulosic materials, timber, etc, which are biodegradable, should be disposed of at authorized designated locations.

#### **12.7.4 Handling and Disposal of Waste**

All construction wastes shall be stored or handled in such a way so as to avoid unnecessary decay or deterioration. Bio-degradable waste during construction shall be collected separately and treated with bio-methanation, organic waste compactors, etc, or subjected to composting.

Construction waste is generally inert in nature (does not contain chemical or biochemical pollution), but proper training is required to handle the construction waste because improper handling may cause accidental damage to the handling person. The person segregating the construction waste should be properly equipped for safety aspects. Spillage of construction waste during transportation should be prevented. There are different sustainable techniques of waste disposal available and should be practiced.

**12.7.5** Every waste resulting from construction, remodeling, repair and demolition of any civil structure of individual or organization shall be managed in accordance with *Construction and Demolition Waste Management Rules, 2016*.

### **12.8 Post-construction Closeout**

Project closeout is a very significant stage from the sustainability considerations. While project management closeout should ensure that the contractual obligations are complied with, the consequences of construction activities should also be appropriately determined. At this stage, the obligations of the project, in terms of physical delivery of works as enshrined in the briefing documents as well as environmental commitments towards sustainability, shall be ensured.

#### **12.8.1 Disposal of Structures and Infrastructure for Construction**

Building and other structures and other infrastructures may need to be demolished/reconstructed partly or completely. These, including their mechanical, electrical, plumbing installations, etc, should be disposed of in a manner so as to facilitate

re-use of materials, components, installations, etc, by the same organization at another construction site or their re-cycle. In case the materials do not have reclaim value, possibility should be explored for their use as backfill materials; otherwise offsite disposal may be resorted to in an appropriate and authorized manner.

### **12.8.2** *Closure of Tube Wells*

Abandoned tube wells are a risk to life. These shall be closed properly. In may also be explored to reuse the same as a part of water harvesting system.

### **12.8.3** *Restoration of Dereliction Caused to Site*

While controlled site dereliction is a good construction practice, the site should be restored deploying appropriate methods. Project budget should include apportionment of resources towards restoration. Such restoration activities may continue for a long time even after physical completion of project, and hence, the commitment towards such efforts is essential. It shall be ensured that the areas, which are under restoration, are well protected during this period.

### **12.8.4** *Re-use of Top Soil*

Re-use of top soil as a resource is an important sustainability consideration. In case the construction site does not leave adequate space for storage of top soil, it is important to identify another location in vicinity for proper storage until it can be reused at the same site or in case it is found not possible to use in the same site, it is taken to other nearby site for use as top soil. Value of top soil should not be compared in financial terms but rather as a scarce natural resource.

## **12.9 Heritage Buildings and New Construction**

Heritage buildings should be given special attention during construction of a new building, especially if it is situated in close vicinity, complying with the requirements of proper architectural controls in accordance with **18** of Part 2 'Administration' of the Code. The following may also be considered while planning and executing such works:

- a) Heritage contents, their characteristics and other building elements that need to be undertaken as scope of work.
- b) Construction techniques including diversion of utility services.
- c) Competence and experience of execution agency to handle such works involving the use of traditional materials and technologies.
- d) Approval of structural and chemical investigation and local understanding, of the heritage structure if it has merit of cultural significance.
- e) Project management processes especially pertaining to time, cost, procurement and risk assessment, risk management and risk preparedness strategy, using the sequences appropriate to traditional works.

- f) Scheduling of activities including review processes and inspections by designated competent persons.
- g) Planning for enabling works and safety such as scaffolds, protection measures for other adjoining works.
- h) Site management including circulation diversions.
- j) Contingencies for unexpected damages to works and unforeseen structural behaviour.
- k) Prevention of fire, flooding and other such emergencies and disasters during works.

### **12.10 Alternate Use, Deconstruction, Dismantling and Demolition**

Built facilities are created to facilitate certain functions. Due to changes in functional use over a period, deterioration in physical condition of building elements, etc, the productivity may decline below threshold. As a result such buildings may be rendered unsuitable in spite of previous renovations. In such situations, effort should be made to re-use of facilities with renovations or remodel for alternate use retaining most of the building and its facilities. Effort may be made to evolve a flexible design so as to make it suitable to varied functional uses.

If design configuration and residual service life is not consistent with functional requirements and particularly considering the safety of the building, the built facility should be de-constructed so as to retrieve as many buildings assemblies/materials/ installations for reuse and recycle, as possible. While working on design details, it shall be ensured that the design should facilitate deconstruction. During the process of de-construction, least damage should be caused to the assemblies, materials and installations. In case of complex structure, such operations shall be undertaken under expert supervision and with proper enabling works.

If built facilities were not designed to facilitate deconstruction, the dismantling should be resorted to in such a manner as to maximize retrieval of materials. Demolition operations shall be planned considering safety of workers; and avoiding damage to adjoining properties; noise, vibrations and air pollution; disruption to continuance of activities in the vicinity; etc. The demolition shall be carried out in accordance with good practices [11(31)].

### **12.11 Disaster Risk Mitigation during Construction**

Sustainable construction practices shall address risks during construction stage from natural and man-made disasters. Natural disasters such as earthquakes, landslides, cyclones, flooding, etc, shall be considered during construction planning and adequately taken into consideration in risk mitigation through the construction methods statement, generally developed by the construction project management team and/or construction agency. Reference shall also be made to Part 6 'Structural Design' of the Code for technical measures for natural disaster mitigation.

In addition to the natural disasters, the risk mitigation against man-made disasters shall also be carried out. Deep excavations causing cave-in due to the lack of proper protection, earth saturation caused due to leaking city sewers/water mains are common man-made disasters. Similarly, fire collapse of structural slabs leading to progressive collapse of slabs below, hoisting of space frames, trusses and concrete segments and operations involving coordinated lifting/hoisting using multiple cranes are some typical situations that may turn disasters. Such operations and processes should have 'fail-safe' detailing as also back-up plan to deal with disasters. Necessary resource deployment shall be part of such disaster planning.

Reference shall also be made to Part 7 'Construction Management, Practices and Safety' of the Code for safety during various construction operations.

### **13 COMMISSIONING, OPERATION, MAINTENANCE AND BUILDING PERFORMANCE TRACKING**

#### **13.1 General**

While the guidelines covered for commissioning and handing over, operation and maintenance and building performance tracking are applicable to majority of building occupancy types, many of these are particularly suited to buildings with high energy consumption such as large office buildings, hospitals, hotels, retail malls, etc.

#### **13.2 Commissioning and Handover**

Commissioning of building services typically includes natural ventilation, renewable energy systems, metering installation, plumbing, lifts and HVAC systems commissioning, etc. Commissioning stage should record the consumption of energy (such as power consumed by fan motors) and water used by plumbing and other systems that will help in reviewing and improving the systems for efficient operation. The commissioning stage helps in identifying any remaining site activities and the training activities that need to be coordinated. It helps in bringing to attention various common problems encountered such as key pieces of hardware are missing, not installed, or defective; installation of sensors, scanners, and other monitoring devices in the wrong locations; and improper coding of the sequence of controls for equipment. These and other problems should be identified and corrected during the commissioning process. Required resources should be allocated to commission the systems after they are installed to ensure that they work as intended. A complete and thorough commissioning of the building shall be done to ensure that the systems will work as intended.

##### **13.2.1 Commissioning Process**

Typically, the first step in the commissioning process should involve formation of a commissioning team that comprises the owner, users, occupants, operation and maintenance (O&M) staff, and design professionals. The next step is the preparation of the project requirements, which should address building systems such as lighting, air-conditioning, water systems, etc, as well as the design intent and the functional specifications for the key building systems. The project design document should include

a commissioning plan. Prior to the handover stage, the commissioning team should verify the installation of the systems, conduct functional performance testing, training of the O&M personnel, etc. A post occupancy commissioning report shall be provided to the owner and/or relevant authorities once the necessary tests have been conducted and the areas that need correction have been rectified.

### **13.2.2 Handover**

During the handover stage, records of meter readings for the different building systems, and other data should be provided to the asset management team. A simple guide for occupants will help the team understand the working of the systems in the building.

## **13.3 Operation and Maintenance**

O&M programmes that focus on improving energy efficiency of building systems can help save energy without a significant capital investment. From small to large sites, these savings can represent significant savings each year, and can be achieved with minimal cash outlays.

Building maintenance is a wide subject covering not only maintenance of building services but also the maintenance of all other aspects including the structure itself. Effective operation and maintenance is one of the most cost effective methods for ensuring reliability, safety and efficiency of a building. Inadequate maintenance of energy-using systems is one of the major causes of energy waste. Energy losses from steam, air and water leaks, uninsulated lines, maladjusted or inoperable controls and from poor maintenance are often considerable. Also, inadequate maintenance of systems that consume water, including plumbing, HVAC and landscaping systems (as applicable), can result in excessive usage of water. Good maintenance practices result in substantial savings in consumption of energy and water, and should be considered as a resource.

Traditionally, O&M is carried out on a reactive basis, where maintenance is only provided when equipment or systems fail. On the contrary, a preventative maintenance programme, that prescribes regular checks of equipment at scheduled intervals, helps to improve system performance and extend its useful life. Predictive maintenance programmes go a step further where rather than following a set schedule of maintenance, checks are used to predict when equipment may be in need of maintenance prior to it experiencing any damage. Such predictions are based on analysis of known factors, for example 'stressors' that can impact the performance of the system. The O&M plan should be complemented by a review of the building operation with one year after the majority of the building area has been occupied. The design and construction/installation teams should also review the O&M manual with the asset management team.

### **13.3.1 Requisites of an O&M Program**

A competent O&M program requires the participation of staff from operations, maintenance, engineering, training and administration. The successful implementation of an O&M programme requires cooperation, dedication, and participation at all levels



including among managers, practitioners, and other technical staff. The O&M plan should be a living document, that is, it is amended as the other requirements change. The intention should be to update O&M document periodically as new procedures and technologies are developed and employed. A web-based version can also be implemented for incorporating updates as frequently as possible.

Revisions to the O&M programme should be considered throughout the assessment process while considering all potential energy savings, and also when capital-intensive projects are being evaluated. Changes to O&M procedures and practices should be considered beyond the scope of repair and regular maintenance. Auditors who conduct performance review of the facility should take a holistic approach, and should consider,

- a) how the activities that are undertaken within the building can be used to optimize energy efficiency in existing operations, and
- b) how the newly implemented measures can improve the performance of the building.

Activities related to O&M should be included in the implementation plan; responsibilities should be designated to individuals; and time lines should be outlined for completing these activities. Training of the staff and awareness programmes should be developed to ensure that there is full compliance among staff for the new procedures to ensure effective implementation of the energy efficiency programme. The O&M plan should refer to the manufacturer's recommendations on equipment operation and maintenance. O&M actions and activities should only be carried out by trained personnel.

#### **13.4 Building Performance Tracking (Measurement and Verification)**

Subsequent to the commissioning and handover stage, regular monitoring of the performance shall be carried out which will provide information on whether the set environmental performance and targets have been met or not. As part of the measurement and verification (M&V) process, an ongoing monitoring of the energy and water systems should be carried out. This will ensure ongoing accountability of energy and water consumption during the life of building. Some of the main attributes of a building performance tracking (measurement and verification) system include the following:

- a) Monitoring of technical and energy performance during first three to five years of occupancy, to ensure that the performance targets during the operation of the building are in line with the expected performance parameters. Energy metering may be provided for the following applications:
  - 1) Lighting (interior and exterior);
  - 2) Air conditioning (heating/cooling);
  - 3) Hot water systems;
  - 4) Renewable energy systems;
  - 5) Energy meters for pumping of municipal water, grey water and irrigation water; and

- 6) Miscellaneous equipment such as elevators, computers escalators, etc.
  - b) Conducting an occupant survey annually for the first three years of the building. This will help in obtaining feedback from the users regarding the effectiveness of the designed systems, as well as identifying possible areas of improvement. These surveys will also provide information about any enhancements or modifications.

Monitoring the performance of plumbing, sanitation and irrigation systems in terms of the water consumed when the building is in operation is an important aspect of the performance tracking system. Metering the water consumed by these systems will help in determining whether the water consumption by the building is in an efficient manner or not. Similarly, measuring and tracking the discharge of water by the building, whether it is storm water, sewage, or otherwise, will provide information on whether the re-use of water is taking place efficiently or not (see **10** for design of water efficient systems).

An energy management and control system (EMCS) is one method of tracking the performance of the energy consumed by the different building systems. EMCS systems typically consist of electronic devices with microprocessors and communication capabilities and utilize widespread use of powerful, low-cost microprocessors and standard cabling communication protocols. EMCS provides a building operator, manager or engineer with basic background information and recommended functions, capabilities, and best practices that will enable the control systems to be fully optimized, resulting in improved quality of life of building occupants and users and more reliable and energy efficient facilities.

#### **13.4.1** *Functions and Capabilities of an EMCS*

An EMCS may be known as building automation system (BAS), building management system (BMS), energy management system (EMS), and facility management system (FMS). In this Part of the Code, the EMCS referred comprises the sensors, transmitters, data acquisition and data processing performed at the user (building) level as well as data and control systems that are more global to full campus control schemes. EMCS may also have a global supervisory controller to perform high-level tasks (for example, resetting temperature set-points based on building conditions and scheduling on/off times). The hardware generally consists of a distributed computer environment with smart controllers strategically located throughout the system (buildings and base-wide network). Several network terminals or computers can be attached to these networks to provide a man-machine interface (MMI).

Depending on its capabilities, EMCS can perform a wide variety of functions. At a minimum, the EMCS has a sensor(s) to measure control variable(s) (for example, temperature and flow rates), a controller with the capability to perform logical operations and produce control outputs, and a controlled device(s) that accepts the control signals and perform actions (for example, move dampers and valves).

### 13.5 Operator Skills and Training

Performance problems result from errors in installation and operation of complex building heating/cooling and other systems. Without the right skill sets and proper training, building operators and managers may not be able to manage the facility optimally even with the most advanced building management systems. One of the key ways to enhance building operations and maintenance performance and thereby achieving the efficiency goals of buildings/facilities is handling by well trained building operators and managers. To operate buildings efficiently, in addition to a good controls infrastructure, the following may be desirable:

- a) Increasing the skill level of operators and maintenance personnel; this can be accomplished by providing the building operators with frequent proper training and incentives for performing well.
- b) Providing adequate engineering supervision of work by technicians to ensure that knowledge of fundamental processes is properly applied for operation and maintenance actions.
- c) Providing operators with system performance feedback; this can be achieved by providing easy-to-use system diagnostic information to correct problems and to understand the cost impacts of improper operations.
- d) Providing incentives for achieving efficiency goals.
- e) Educating everyone who influences the decisions relating to planning, budget, design, and procurement of energy, water and related systems.

### 13.6 Control-System Maintenance

Maintenance of the control system is critical in ensuring its performance after installation and commissioning. Many factors can cause degradation of the control systems performance post-commissioning such as:

- a) Overrides of automatic control by operations staff, a frequent problem, generally driven by customer complaints;
- b) Drift or failure of sensors;
- c) Failure of actuators;
- d) Corroded or failed wires and their connections;
- e) Improper changes to control schedules (sometimes temporary changes become permanent changes by oversight); and
- f) Degradation or failure of controlled devices.

These problems can be prevented by good operation and maintenance practices, such as a reporting system for all overrides, periodic re-commissioning of the control system, and maintenance of the control system and the physical components it actuates. Automated fault detection and diagnostic tools, alarms, plots of trend data, and maintenance tracking systems may be used to help in identifying performance degradation, faults and the need for maintenance and for compliance of recommendations of these tools and taking action, by the maintenance personnel.

It is recommended that the control system specifications include requirements for maintenance documents and a maintenance plan. The facility should also consider contracting for maintenance support, if it is not provided in-house. In procuring maintenance support, the organization should ensure that the maintenance contract requires maintenance of all systems in a manner that ensures continuous, or nearly continuous proper operation of all controls and controlled devices. This requires frequent, periodic inspection, testing, and evaluation of systems and equipment followed by the correction of any defects found. System inspection, testing and evaluation can be automated *via* continuous monitoring tools.

**ANNEX A**  
(Clause 8.1)

**DESIGN STRATEGIES AS PER CLIMATE ZONES FOR VARIOUS SEASONS**

**A-1 SUMMER PERIOD**

<i>Design Strategy</i>	<i>Hot Dry Climate</i>	<i>Warm Humid Climate</i>	<i>Moderate Climate</i>	<i>Composite Climate</i>	<i>Cold Climate</i>
(1)	(2)	(3)	(4)	(5)	(6)
Reduction in the ingress of heat during the day (by insulation, thermal mass, buffer spaces, orientation, shading, etc)	√	√	√	√	√
Introduction of naturally (through use of courtyard, wind towers, properly positioned windows, etc) or mechanically pre-cooled air, into the building with adequate air-flow during the day	√	√ (substantive increase recommended)	-	√	√
Adequacy of airflow of naturally (through the use of courtyard, wind towers, properly positioned windows, etc) or mechanically pre-cooled air during the night	√	√ (substantive increase recommended)	√(naturally only)	√	√
Reduction of the temperature variation within the building during the day/night, in comparison to temperature variation in the ambient temperature	√	-	-	√	√
Adequacy air changes, as required by the activities within building, and the density of the occupancy	√	√ (substantive increase recommended)	√	√	√

**A-2 WINTER PERIOD**

<i>Design Strategy</i>	<i>Hot Dry Climate</i>	<i>Warm Humid Climate</i>	<i>Moderate Climate</i>	<i>Composite Climate</i>	<i>Cold Climate</i>
(1)	(2)	(3)	(4)	(5)	(6)
Reduction in the ingress of cold into the building during the day, as well as during the night (by insulation, buffer spaces, orientation, weather stripping, etc)	√	√	-	√	√ (substantive reduction recommended)
Reduction in the air changes, without compromising with the	√	-	√	-	

minimum requirements for the activities, as well as for the density of the occupancy					√(substantive reduction recommended)
Reduction in the egress of heat from within the building spaces during the day as well as during the night	√	-	-	√	√(substantive reduction recommended)
Adequacy of natural ventilation/air changes in all spaces, as per requirement of maintaining indoor air quality	-	√	-	√	-
Marginal reduction in the ingress of cold into the building during the day as well as during the night	-	-	√	-	-

**A-3 MONSOON PERIOD**

<i>Design Strategy</i>	<i>Hot Dry Climate</i>	<i>Warm Humid Climate</i>	<i>Moderate Climate</i>	<i>Composite Climate</i>	<i>Cold Climate</i>
(1)	(2)	(3)	(4)	(5)	(6)
Reduction in the ingress of heat from outside into the building (by insulation, thermal mass, buffer spaces, orientation, shading, etc)	√	√	√	√	√
Substantive increase in the airflow/velocity/air changes during the day as well as the night	√	√	√	√	√
Reduction of humidity within the building throughout the day and night (using dehumidifiers, desiccant cooling, etc)	√	√	√	√	√
Substantive increase in the natural ventilations in all spaces	-	√	-	-	-

**ANNEX B**  
[Clauses 8.2(a), C-1 and D-1]

**PRESCRIPTIVE METHOD FOR ENVELOPE OPTIMIZATION**

**B-1 ROOFS**

Roofs shall comply with either the maximum assembly  $U$ -value or the minimum insulation  $R$ -value in Table 15.  $R$ -value is for the insulation alone and does not include building materials or air films. The roof insulation shall not be located on a suspended ceiling with removable ceiling panels.

Cool roofs with slopes less than  $20^\circ$  shall have an initial solar reflectance of not less than 0.70 and an initial emittance not less than 0.75.

**Table 15 Roof Assembly  $U$ -Value and Insulation  $R$ -Value Requirements**  
(Clause B-1)

SI No.	Climate Zone	24 h Use Buildings		Daytime use buildings	
		Hospitals, Hotels, Call Centres, etc		Other Building Types	
		Maximum $U$ -Value of the Overall Assembly	Minimum $R$ -Value of Insulation Alone	Maximum $U$ -Value of the Overall Assembly	Minimum $R$ -Value of Insulation Alone
		W/m <sup>2</sup> C	m <sup>2</sup> C/W	W/m <sup>2</sup> C	m <sup>2</sup> C/W
(1)	(2)	(3)	(4)	(5)	(6)
i)	Composite	U-0.261	R-3.5	U-0.409	R-2.1
ii)	Hot and dry	U-0.261	R-3.5	U-0.409	R-2.1
iii)	Warm and humid	U-0.261	R-3.5	U-0.409	R-2.1
iv)	Moderate	U-0.409	R-2.1	U-0.409	R-2.1
v)	Cold	U-0.261	R-3.5	U-0.409	R-2.1

**B-2 OPAQUE WALLS**

Opaque walls shall comply with either the maximum assembly  $U$ -Value or the minimum insulation  $R$ -Value in Table 16.  $R$ -Value is for the insulation alone and does not include building materials or air films.

**Table 16 Opaque Wall Assembly  $U$ -Value and Insulation  $R$ -Value Requirements**  
(Clause B-2)

SI No.	Climate Zone	24 h Use Buildings Hospitals, Hotels, Call Centres, etc		Daytime Use Buildings Other Building Types	
		Maximum <i>U</i> -Value of the Overall Assembly W/m <sup>2</sup> C	Minimum <i>R</i> -Value of Insulation Alone m <sup>2</sup> C/W	Maximum <i>U</i> -Value of the Overall Assembly W/m <sup>2</sup> C	Minimum <i>R</i> -Value of Insulation Alone m <sup>2</sup> C/W
(1)	(2)	(3)	(4)	(5)	(6)
i)	Composite	U-0.440	R-2.10	U-0.440	R-2.10
ii)	Hot and dry	U-0.440	R-2.10	U-0.440	R-2.10
iii)	Warm and humid	U-0.440	R-2.10	U-0.440	R-2.10
iv)	Moderate	U-0.431	R-1.80	U-0.397	R-2.00
v)	Cold	U-0.369	R-2.20	U-0.352	R-2.35

### B-3 VERTICAL FENESTRATION

Vertical fenestration shall comply with the maximum area weighted *U*-Value and maximum area weighted SHGC requirements of Table 17. Vertical fenestration area is limited to a maximum of 60 percent of the gross wall area for the prescriptive requirement.

**Table 17 Vertical Fenestration *U*-Value and SHGC Requirements**  
(Clause B-3)

SI No.	Climate	Maximum <i>U</i> -Value W/m <sup>2</sup> C	Maximum SHGC	
			WWR ≤ 40 percent	40 percent < WWR ≤ 60 percent
(1)	(2)	(3)	(4)	(5)
i)	Composite	3.30	0.25	0.20
ii)	Hot and dry	3.30	0.25	0.20
iii)	Warm and humid	3.30	0.25	0.20
iv)	Moderate	6.90	0.40	0.30
v)	Cold	3.30	0.51	0.51

Alternative overhangs and/or side fins may be applied in determining the SHGC for the proposed design. An adjusted SHGC, accounting for overhangs and/or side fins is calculated by multiplying the SHGC of the unshaded fenestration product times a



multiplication ( $M$ ) factor. If this exception is applied, a separate  $M$  factor shall be determined from Table 5 for each orientation and unique shading condition.

Vertical fenestration areas located more than 2.2 m above the level of the floor are exempt from the SHGC requirement in Table 17, if the following conditions are complied with:

- a) The total effective aperture for the elevation is less than 0.25, including all fenestration areas greater than 1.0 m above the floor level; and
- b) An interior light shelf is provided at the bottom of this fenestration area, with an interior projection factor (PF) not less than:
  - 1) 1.0 for *EW*, *SE*, *SW*, *NE*, and *NW* orientations;
  - 2) 0.5 for *S* orientation; and
  - 3) 0.35 for *N* orientation when latitude is less than 23°.

### **B-3.1 Minimum Visible Transmission (VLT) of Glazing for Vertical Fenestration**

To permit the use of available day lighting in place of electric lighting, glazing products used in offices, banks, libraries, classrooms with predominant daytime usage, shall have the minimum VLT, defined as function of WWR, where effective aperture is greater than 0.1, equal to or greater than the minimum VLT requirements of Table 18. Table 18 also indicates recommended VLT ranges for daylight applications in such spaces.

**Table 18 Minimum Visual Light Transmission Light Transmission Requirements**

(Clause B-3.1)

<b>SI No.</b>	<b>Window Wall Ratio</b>	<b>Minimum VLT</b>
(1)	(2)	(3)
i)	0 - 0.3	0.27
ii)	0.31 - 0.4	0.20
iii)	0.41 - 0.5	0.16
iv)	0.51 - 0.6	0.13
v)	0.61 - 0.7	0.11

### **B-4 SKYLIGHT**

Skylights shall comply with the maximum  $U$ -value and a maximum SHGC requirement of Table 19. Skylight area is limited to a minimum of 5 percent of the gross roof area for the prescriptive requirement.

**Table 19 Skylight  $U$ -Value and SHGC requirements**  
(Clause B-4)

SI No.	Climate	Maximum $U$ value ( $W/m^2\text{°C}$ )		Maximum SHGC	
		With Curb	Without Curb	0 - 2 Percent SRR	2.1 - 5 Percent SRR
(1)	(2)	(3)	(4)	(5)	(6)
i)	Composite	11.24	7.71	0.40	0.25
ii)	Hot and dry	11.24	7.71	0.40	0.25
iii)	Warm and humid	11.24	7.71	0.40	0.25
iv)	Moderate	11.24	7.71	0.61	0.4
v)	Cold	11.24	7.71	0.61	0.4

**ANNEX C**  
[Clause 8.2(b)]

**TRADE-OFF METHOD FOR ENVELOPE OPTIMIZATION**

**C-1** The building envelope complies with the Code, if the building envelope performance factor (EPF) of the proposed design is less than the standard design, where the standard design exactly complies with the criteria in Annex B. The envelope performance factor shall be calculated using the following equations:

$$EPF_{Total} = EPF_{Roof} + EPF_{Wall} + EPF_{Fenest}$$

where

$$EPF_{Roof} = c_{Roof} \sum_{s=1}^n U_s A_s$$

$$EPF_{Wall} = c_{Wall, Mass} \sum_{s=1}^n U_s A_s + c_{Wall, Other} \sum_{w=1}^n U_s A_s$$

$$EPF_{Fenest} = c_{1Fenest, North} \sum_{w=1}^n SHGC_w M_w A_w + c_{2Fenest, North} \sum_{w=1}^n U_w A_w + c_{1Fenest, NonNorth} \sum_{w=1}^n SHGC_w M_w A_w + c_{2Fenest, NonNorth} \sum_{w=1}^n U_w A_w + c_{1Fenest, Skylight} \sum_{s=1}^n SHGC_s A_s + c_{2Fenest, Skylight} \sum_{s=1}^n U_s A_s$$

and

$EPF_{Wall}$ , $EPF_{Fenest}$ and $EPF_{Roof}$	= envelope performance factor for walls, fenestration and roofs respectively;
$A_s$ , $A_w$	= area of a specific envelope component referenced by the subscript 's' or for windows reference by the subscript 'w';
$SHGC_w$ , $SHGC_s$	= solar heat gain coefficient for windows and skylights;
$M_w$	= multiplier for the $SHGC_w$ that depends on the projection factor of an overhang or side fin as given in Table 5;
$U_s$	= $U$ -value for the envelope component referenced by the subscript 's';
$c_{Roof}$ ; $c_{Wall, mass}$ ; $c_{Wall, Other}$ ; $c_{Fenest, North}$ ; $c_{Fenest, Non North}$ ; $c_{Fenest, Skylight}$	= coefficients for the roof, wall, window and skylight class of construction. Values of $c$ are taken from Table 20 to Table 24 for each class of construction.

**Table 20 Envelope Performance Factor Coefficients – Composite Climate**  
(Clause C-1)

SI No.	Building Component	Daytime Occupancy		24 h Occupancy	
		U-Value W/m <sup>2</sup> K	SHGC	U-Value W/m <sup>2</sup> K	SHGC
(1)	(2)	(3)	(4)	(5)	(6)
i)	Mass walls	6.01	–	13.85	–
ii)	Curtain walls, other walls	15.72	–	20.48	–
iii)	Roofs	11.93	–	24.67	–
iv)	North windows	- 1.75	40.65	- 4.56	58.15
v)	Non-north windows	- 1.25	54.51	0.68	86.57
vi)	Skylights	- 96.35	311.71	- 294.66	918.77

**Table 21 Envelope Performance Factor Coefficients – Hot Dry Climate**  
(Clause C-1)

SI No.	Building Component	Daytime Occupancy		24 h Occupancy	
		U-Value W/m <sup>2</sup> K	SHGC	U-Value W/m <sup>2</sup> K	SHGC
(1)	(2)	(3)	(4)	(5)	(6)
i)	Mass walls	5.48	–	15.01	–
ii)	Curtain walls, other walls	6.38	–	22.06	–
iii)	Roofs	11.14	–	25.98	–
iv)	North windows	- 2.40	36.57	- 1.49	56.09
v)	Non-north windows	- 1.86	46.79	1.187	81.79
vi)	Skylights	- 96.27	309.33	- 295.81	923.01

**Table 22 Envelope Performance Factor Coefficient – Warm Humid Climate**  
(Clause C-1)

SI No.	Building Component	Daytime Occupancy		24 h Occupancy	
		U-Value W/m <sup>2</sup> K	SHGC	U-Value W/m <sup>2</sup> K	SHGC
(1)	(2)	(3)	(4)	(5)	(6)
i)	Mass walls	6.42	–	9.60	–
ii)	Curtain walls, other walls	14.77	–	19.71	–

iii)	Roofs	9.86	–	14.11	–
iv)	North windows	-1.58	34.95	- 7.29	64.19
v)	Non-north windows	- 1.00	43.09	- 6.48	76.83
vi)	Skylights	- 96.11	305.45	- 295.45	893.55

**Table 23 Envelope Performance Factor Coefficient – Temperate Climate**  
(Clause C-1)

SI No.	Building Component	Daytime Occupancy		24 h Occupancy	
		U-Value W/m <sup>2</sup> K	SHGC	U-Value W/m <sup>2</sup> K	SHGC
(1)	(2)	(3)	(4)	(5)	(6)
i)	Mass walls	2.017	–	3.11	–
ii)	Curtain walls, other walls	2.72	–	4.11	–
iii)	Roofs	5.46	–	5.86	–
iv)	North windows	- 3.10	29.66	- 11.95	62.14
v)	Non-north windows	- 2.98	34.86	- 11.62	68.45
vi)	Skylights	- 96.21	298.82	- 294.12	876.70

**Table 24 Envelope Performance Factor Coefficient – Cold Climate**  
(Clause C-1)

SI No.	Building Component	Daytime Occupancy		24 h Occupancy	
		U-Value W/m <sup>2</sup> K	SHGC	U-Value W/m <sup>2</sup> K	SHGC
(1)	(2)	(3)	(4)	(5)	(6)
i)	Mass walls	5.19	-	5.19	-
ii)	Curtain walls, other walls	6.76	-	6.76	-
iii)	Roofs	5.69	-	5.67	-
iv)	North windows	1.55	9.13	1.55	9.13
v)	Non-north windows	- 1.13	16.32	- 1.13	16.32
vi)	Skylights	- 93.44	283.18	- 93.44	283.18

**ANNEX D**  
[Clause 8.2(c)]

**WHOLE BUILDING ANALYSIS METHOD FOR ENVELOPE OPTIMIZATION**

**D-1** A building complies with the whole building performance requirement when the estimated annual energy use of the proposed design is less than the standard design, even though it may not comply with the specific requirements of the prescriptive requirements given in Annex B. Annual energy use for the purposes of the whole building performance method shall be calculated, in kilowatt-hours (kWh), of electricity use per year.

**D-2 SIMULATION GENERAL REQUIREMENTS**

A simulation program may be used for the analysis of energy consumption in buildings to model the following:

- b) Energy flows on an hourly basis for all 8 760 h in the year;
- c) Hourly variations in occupancy, lighting power, miscellaneous equipment power, thermostat set points and HVAC system operation, defined separately for each day of the week and holidays;
- d) Thermal mass effects;
- e) Ten or more thermal zones;
- f) Part-load and temperature dependent performance of heating and cooling equipment;
- g) Airside and waterside economizers with integrated control; and
- h) All the standard design characteristics specified in this chapter.

The simulation program shall use hourly values of climatic data, such as temperature and humidity from representative climatic data, for the city in which the proposed building is to be located. For cities or urban regions with several climatic data entries, and for locations where weather data are not available, the designer shall select available weather data that best represent the climate at the construction site.

The proposed design and standard design shall be calculated using the following:

- 1) Same simulation program;
- 2) Same weather data; and
- 3) Same building operation assumptions (thermostat set points, schedules, internal gains, occupant loads, etc).

**D-3 CALCULATING THE ENERGY CONSUMPTION OF THE PROPOSED DESIGN AND THE STANDARD DESIGN**

The simulation model for calculating the proposed design and the standard design shall be developed in accordance with the requirements in Table 25. The HVAC system type

and related performance parameters for the standard design shall be determined from Table 26 and the following rules:

- a) All HVAC and service water heating equipment in the standard design shall be modelled at the minimum efficiency levels, both part load and full load.
- b) Where efficiency ratings, such as energy efficiency ratio (EER) and coefficient of performance (COP), include fan energy, the descriptor shall be broken down into its components so that supply fan energy can be modelled separately.
- c) Minimum outdoor air ventilation rates shall be the same for both the standard design and the proposed design.
- d) The equipment capacities for the standard design shall be sized proportionally to the capacities in the proposed design based on sizing runs; that is, the ratio between the capacities used in the annual simulations and the capacities determined by the sizing runs shall be the same for both the proposed design and standard design. Unmet load hours for the proposed design shall not differ from unmet load hours for the standard design by more than 50 h.

Components and parameters not listed in Table 26 or otherwise specifically addressed in this Part of the Code shall be identical to those in the proposed design. Where there are specific requirements in this Part of the Code the component efficiency in the standard design shall be adjusted to the lowest efficiency level allowed by the requirement for that component type.

**Table 25 Modelling Requirements for Calculating Proposed and Standard Design**  
(Clause D-3)

SI No. (1)	Case (2)	Proposed Building (3)	Standard Design (4)
i)	Design model	<p>a) The simulation model of the proposed design shall be consistent with the design documents, including proper accounting of fenestration and opaque envelope types and area; interior lighting power and controls; HVAC system types, sizes, and controls; and service water heating systems and controls</p> <p>b) When the whole building performance method is applied to buildings in which energy-related features have not yet been designed (for example, a lighting system), those yet-to-be-designed features shall be described in the</p>	The standard design shall be developed by modifying the proposed design as described in this table. Except as specifically instructed in this table, all building systems and equipment shall be modelled identically in the standard design and proposed design

SI No. (1)	Case (2)	Proposed Building (3)	Standard Design (4)
		proposed design so that they minimally comply with applicable mandatory and prescriptive requirements	
ii)	Space classification	use The building type or space type classifications shall be chosen in accordance with this code. More than one building type category may be used in a building if it is a mixed-use facility	Same as proposed design
iii)	Schedules	The schedules shall be typical of the proposed building type as determined by the designer	Same as proposed design
iv)	Building envelope	All components of the building envelope in the proposed design shall be modelled as shown on architectural drawings or as installed for existing building envelopes	The standard design shall have identical conditioned floor area and identical exterior dimensions and orientations as the proposed design, except as noted in (a) to (d)
		<i>Exceptions:</i> The following building elements are permitted to differ from architectural drawings:	
		a) Any envelope assembly that covers less than 5 percent of the total area of that assembly type (for example, exterior walls) need not be separately described. If not separately described, the area of an envelope assembly shall be added to the area of the adjacent assembly of that same type	a) <i>Orientation</i> – The baseline building performance shall be generated by simulating the building with its actual orientation and again after rotating the entire building 90°, 180°, 270°, then averaging the results. The building shall be modelled so that it does not shade itself
		b) Exterior surfaces whose azimuth orientation and tilt differ by no more than 45° and are otherwise the same may be described as either a single surface or by using multipliers	b) Opaque assemblies such as roof, floors, doors, and walls shall be modelled as having the same heat capacity as the proposed design but with the minimum <i>U value</i> required in <b>B-1</b> and <b>B-2</b>
		c) For exterior roofs other than roofs with ventilated attics, the reflectance and emittance of the roof surface shall be modelled	c) <i>Fenestration</i> — Fenestration areas shall equal that in the proposed design or 40 percent of gross above grade wall area, whichever is smaller, and shall be distributed uniformly in horizontal bands across the four orientations. No shading projections are to be modelled; fenestration shall be assumed to be flush with the exterior wall or roof. Manually operated fenestration shading devices such as blinds or shades
		d) Manually operated fenestration shading devices such as blinds or shades shall not be modelled. Permanent shading devices such	



SI No. (1)	Case (2)	Proposed Building (3)	Standard Design (4)
		as fins, overhangs, and light shelves shall be modelled	shall not be modelled. Fenestration <i>U value</i> shall be the minimum required for the climate, and the solar heat gain coefficient shall be the maximum allowed for the climate and orientation
			d) <i>Roof albedo</i> – All roof surfaces shall be modelled with a reflectivity of 0.30
v)	Lighting	<p>Lighting power in the proposed design shall be determined as follows:</p> <p>a) Where a complete lighting system exists, the actual lighting power shall be used in the model</p> <p>b) Where a lighting system has been designed, lighting power shall be determined</p> <p>c) Where no lighting exists or is specified, lighting power shall be determined for the appropriate building type</p> <p>d) Lighting system power shall include all lighting system components shown or provided for on plans (including lamps, ballasts, task fixtures, and furniture-mounted fixtures)</p>	<p>Lighting power in the standard design shall be determined using the same categorization procedure (building area or space function) and categories as the proposed design, with the lighting power to be set equal to the maximum allowed for the corresponding method and category in either Table 26 or Table 27. Power for fixtures not included in the lighting power density calculation shall be modelled identically in the proposed design and standard design</p>
vi)	HVAC system	<p>The HVAC system type and all related performance parameters, such as equipment capacities and efficiencies, in the proposed design shall be determined as follows:</p> <p>a) Where a complete HVAC system exists, the model shall reflect the actual system type using actual component capacities and efficiencies</p> <p>b) Where an HVAC system has been designed, the HVAC model shall be consistent with design documents. Mechanical equipment efficiencies shall be adjusted from actual design conditions to the standard rating</p>	<p>The HVAC system type and related performance parameters for the standard design shall be determined from Table 28. Equipment performance shall meet the requirements of this Code and the relevant Indian Standards</p>

SI No. (1)	Case (2)	Proposed Building (3)	Standard Design (4)
		conditions, if required by the simulation model	
		c) Where no heating system exists or no heating system has been specified, the heating system shall be modelled as electric resistance. The system characteristics shall be identical to the system modelled in the standard design	
		d) Where no cooling system exists or no cooling system has been specified, the cooling system shall be modelled as an air-cooled single zone system, one unit per thermal block. The system characteristics shall be identical to the system modelled in the standard design	
vii)	Service hot water	The service hot water system type and all related performance parameters, such as equipment capacities and efficiencies, in the proposed design shall be determined as follows:	The water heating system shall be of the same type of the proposed design  For residential facilities, hotels and hospitals the standard design shall have a solar system capable of meeting 20 percent of the design load
		a) Where a complete service hot water system exists, the model shall reflect the actual system type using actual component capacities and efficiencies	Systems shall meet the prescribed efficiency requirements of equipment, pipe insulation and incorporate heat traps in accordance with the relevant applicable Indian Standards
		b) Where a service hot water system has been designed, the service hot water model shall be consistent with design documents	
		c) Where no service hot water system exists or is specified, no service hot water heating shall be modelled	
viii)	Miscellaneous load	Receptacle, motor, and process loads shall be modelled and estimated based on the building type or space type category	Receptacle, motor and process loads shall be modelled the same as the proposed design. The water heating system shall be of the same type of the proposed design
		These loads shall be included in simulations of the building and shall be included when calculating the	

SI No. (1)	Case (2)	Proposed Building (3)	Standard Design (4)
		standard design and proposed design. All end-use load components within and associated with the building shall be modelled, unless specifically excluded, but not limited to, exhaust fans, parking garage ventilation fans, exterior building lighting, swimming pool heaters and pumps, elevators and escalators, refrigeration equipment, and cooking equipment	
ix)	Modelling limitations to the simulation Program	<p>If the simulation program cannot model a component or system included in the proposed design, one of the following methods shall be used with the approval of the authority having jurisdiction:</p> <p>a) Ignore the component if the energy impact on the trade-offs being considered is not significant</p> <p>b) Model the component substituting a thermodynamically similar component model</p> <p>c) Model the HVAC system components or systems using the standard design's HVAC system in accordance with SI No. (vi)</p> <p>Whichever method is selected, the component shall be modelled identically for both the proposed design and standard design models</p>	Same as the proposed case

NOTE – The energy simulation results shall be reported for the proposed building and standard design and the percentage savings in annual energy consumption achieved each for interior lighting, exterior lighting, HVAC, domestic hot water and other/miscellaneous equipment consuming substantial energy. The total energy savings for all equipment, that is, total building load shall also be reported.

**Table 26 Interior Lighting Power - Building Area Method**  
(Table 25)

SI No. (1)	Building Area Type (2)	LPD W/m <sup>2</sup> (3)

i)	Automotive facility	9.7
ii)	Convention center	12.9
iii)	Court house	12.9
iv)	Dining: bar/lounge/leisure	14.0
v)	Dining: cafeteria/fast food	15.1
vi)	Dining: family	17.2
vii)	Dormitory	10.8
viii)	Exercise center	10.8
ix)	Gymnasium	11.8
x)	Healthcare-clinic	10.8
xi)	Hospital/health care	12.9
xii)	Hotel	10.8
xiii)	Library	14.0
xiv)	Manufacturing facility	14.0
xv)	Motel	10.8
xvi)	Motion picture theater	12.9
xvii)	Multifamily	7.5
xviii)	Museum	11.8
xix)	Office	10.8
xx)	Parking garage	3.2
xxi)	Penitentiary	10.8
xxii)	Performing arts theater	17.2
xxiii)	Police/fire station	10.8
xxiv)	Post office	11.8
xxv)	Religious building	14.0
xxvi)	Retail	16.1
xxvii)	School/university	12.9
xxviii)	Sports arena	11.8
xxix)	Town hall	11.8
xxx)	Transportation	10.8
xxx)	Warehouse	8.6
xxxii)	Workshop	15.1

NOTE – In cases where both a general building area type and a specific building area type are listed, the specific building area type shall apply.

**Table 27 Interior Lighting Power – Space Function Method**  
(Table 25)

SI No. (1)	Building Area Type (2)	LPD (W/m <sup>2</sup> ) (3)
i)	Office-enclosed	11.8
ii)	Office-open plan	11.8
iii)	Conference/meeting/multipurpose	14.0
iv)	Classroom/lecture/training	15.1
v)	Lobby	14.0

vi)	For hotel	11.8
vii)	For performing arts theater	35.5
viii)	For motion picture theater	11.8
ix)	Audience/seating area	9.7
x)	For gymnasium	4.3
xi)	For exercise center	3.2
xii)	For convention center	7.5
xiii)	For religious buildings	18.3
xiv)	For sports arena	4.3
xv)	For performing arts theater	28.0
xvi)	For motion picture theater	12.9
xvii)	For transportation	5.4
xviii)	Atrium-first three floors	6.5
xix)	Atrium-each additional floor	2.2
xx)	Lounge/recreation	12.9
xxi)	For hospital	8.6
xxii)	Dining area	9.7
xxiii)	For hotel	14.0
xxiv)	For motel	12.9
xxv)	For bar lounge/leisure dining	15.1
xxvi)	For family dining	22.6
xxvii)	Food preparation	12.9
xxviii)	Laboratory	15.1
xxix)	Restrooms	9.7
xxx)	Dressing/locker/fitting room	6.5
xxxi)	Corridor/transition	5.4
xxxii)	For hospital	10.8
xxxiii)	For manufacturing facility	5.4
xxxiv)	Stairs-active	6.5
xxxv)	Active storage	8.6
xxxvi)	For hospital	9.7
xxxvii)	Inactive storage	3.2
xxxviii)	For museum	8.6
xxxix)	Electrical/mechanical	16.1
xl)	Workshop	20.5
xli)	Sleeping quarters	3.2
xlII)	Convention centre - exhibit space	14.0
xlIII)	Library	
	a) Card file & cataloguing	11.8
	b) Stacks	18.3
	c) Reading area	12.9
xliv)	Hospital	
	a) Emergency	29.1
	b) Recovery	8.6
		10.8

	c) Nurse station	16.1
	d) Exam treatment	12.9
	e) Pharmacy	7.5
	f) Patient room	23.7
	g) Operating room	6.5
	h) Nursery	15.1
	j) Medical supply	9.7
	k) Physical therapy	4.3
	m) Radiology	6.5
	n) Laundry - washing	
xliv)	Automotive - service repair	7.5
xlvi)	Manufacturing	
	a) Low bay (<8m ceiling)	12.9
	b) High bay (>8m ceiling)	18.3
	c) Detailed manufacturing	22.6
	d) Equipment room	12.9
	e) Control room	5.4
xlvii)	Hotel/motel guest rooms	11.8
xlviii)	Dormitory - living quarters	11.8
xlix)	Museum	
	a) General exhibition	10.8
	b) Restoration	18.3
	c) Bank office - banking activity area	16.1
l)	Religions buildings	
	a) Worship-pulpit, choir	25.8
	b) Fellowship hall	9.7
li)	Retail	
	a) Sales area	18.3
	b) Mall concourse	18.3
lii)	Sports arena	
	a) Ring sports area	29.1
	b) Court sports area	24.8
	c) Indoor field area	15.1
liii)	Warehouse	
	a) Fine material storage	15.1
	b) Medium/bulky material storage	9.7
	c) Parking garage - garage area	2.2
liv)	Transportation	
	a) Airport - concourse	6.5

b) Air/train/bus - baggage area	10.8
c) Terminal - ticket counter	16.1

**Table 28 HVAC Systems Map**  
(Clause D-3)

SI No.	Parameter	Residential	Non Residential		
		More than 3 Stories	Less than 3 floors or less than 7 500 m <sup>2</sup>	4 or 5 floors or less than 7 500 m <sup>2</sup> or 5 floors or less and 7 500 – 15 000 m <sup>2</sup>	More than 5 floors or more than 15 000 m <sup>2</sup>
(1)	(2)	(3)	(4)	(5)	(6)
i)	System Type	Packaged terminal air conditioner	Packaged rooftop air conditioner	Central cooling plant with constant volume AHU for each zone	Central cooling plant with constant volume AHU for each zone
ii)	Fan control	Constant volume	Constant volume	Constant volume air handler for each zone	Variable volume air handler
iii)	Cooling type	Direct expansion	Direct expansion	Chilled water	Chilled water
iv)	Heating type	Electric resistance	Electric resistance	Electric resistance	Electric resistance

NOTE – If the proposed building has an air cooled chiller/system then the budget building shall have Air cooled chiller otherwise the budget case shall have water cooled centrifugal chillers.

**ANNEX E**  
*(Foreword)*

**DATA COLLECTION TEMPLATE FOR EMBODIED ENERGY AND CARBON OF  
INDIAN CONSTRUCTION MATERIALS**

**E-1** A standardized data collection template has been developed to ensure consistency in the embodied energy and carbon data collection process. The template was informed by the data quality goals and indicators, which would, in turn, ensure good data quality. The data collection template shall collect information pertaining to the first three lifecycle stages, namely – A1, concerning Raw Material extraction; A2, concerning Raw Material transportation between the extraction site and manufacturing plant; and A3, concerning material manufacturing. Additionally, the data collection template shall collect metadata concerning the data collection process, such as its temporal and spatial specificity, details about the manufacturing plant etc.

The Contributor should wish to keep the below-mentioned instructions in mind while collecting data and filling it out in the data collection template.

- a) The Contributor should create an MS Excel file, titling it 'Emb\_Energy\_Carbon\_Indian\_Material\_Contributor\_name\_ddmmmyyy.xlsx,' and fill out the data. The file could contain six sheets. The first sheet would contain the Contributor's details, such as their background, email address, affiliation, and information about the publication of contributed data; it could be titled 'Contributor Details.' The second sheet would contain metadata about the material and the data collection campaign; it could be titled 'Metadata.' The third sheet would encompass information related to the raw material extraction or A1 lifecycle stage; it could be titled 'A1.' The fourth sheet would contain information related to the transportation between the extraction and manufacturing plant site or the A2 lifecycle stage; it could be titled 'A2.' The fifth sheet would contain information about the material manufacturing or A3 lifecycle stage; it could be titled 'A3.' The sixth sheet will only be filled if the Contributor has aggregated A1-A3 Embodied Energy or Carbon value; it could be titled 'A1-A3.'
- b) The column headers mentioned in table 29, 30, and table 32 to Table encompass all the data the Contributor should need to collect. These tables mention a description of the column headers, elaborating on what needs to be collected, and a data entry type which dictates the format in which data will be entered/accepted. Here, an 'alphanumeric' and 'numeric' data entry type indicates that the data should be manually typed out; it could contain both text and numbers. On the other hand, the select from below mentioned predefined options data entry type



indicates that the contributor would need to select one or more options from the mentioned list.

- c) The column headers mentioned in table 29 are the column headers for the contributor's details sheet.
- d) The column headers mentioned in table 30 and table 32 are the column headers for the metadata sheet.
- e) The column headers mentioned in table 33 to table 36 are the column headers for the 'A1' sheet. The column headers mentioned in table 37 to table 40 are the column headers for the 'A2' sheet. The column headers mentioned in table 41 to table 44 are the column headers for the 'A3' sheet. If the contributor does have the relevant information on the individual lifecycle stages, then they can enter the per kg embodied energy and carbon value in [CA<sub>1-3</sub>] and [HA<sub>1-3</sub>] in table 45.
- f) In case the contributor does not have information on the individual lifecycle stages and only has a composite A1-A3 embodied energy or carbon value, then such data can be entered in the 'A1-A3' sheet. The column headers mentioned in table 45 are the column headers for the 'A1-A3' sheet.
- g) Please note that across this document, finished construction material refers to a finished material used for building construction, such as cement, steel, aggregate, etc. Furthermore, Raw Materials or feedstock material refers to the raw material needed to manufacture the finished construction material.
- h) Notably, all the fuel, embodied energy, and carbon data across table 33 through table 44 are being reported in reference to the mentioned specific quantity of the finished construction material and/or raw material. However, the per kg embodied energy and carbon impacts can be calculated and only be mentioned in [CA<sub>1-3</sub>] and [HA<sub>1-3</sub>] in table 45.
- j) All numeric data entries are to be rounded off up to two decimal places. The units in which embodied energy and carbon are expressed should be consistent across all lifecycle stages. For instance, declaring embodied carbon in terms of kg CO<sub>2</sub> for A1 and in terms of kg CO<sub>2e</sub> in A2 is unacceptable.
- k) Essentially, the contributor should feel free to contribute as much data for as many lifecycle stages as available; all data would be acceptable. For example, it would be acceptable if the contributor shared data related to only one of the lifecycle stages, and it would be acceptable if they shared data related to any two or all three of the lifecycle stages.
- m) The contributor is encouraged to provide documentation of the entire extraction, transportation, and manufacturing processes. It would be beneficial if they could describe data collection methods or the statistical protocol to assess the validity of measured sources.
- n) \* denotes mandatory data fields; + denotes separate, new rows for each new entry.

**Table 29 Contributor's Details**

*(Clause E-1)*

Column Headers	Contributor Background*	Contributor Affiliation*	Contributor Email Address*	Has the data been published in a peer-reviewed article?*	Corresponding Author	Publication Title	Publication Link
	[A]	[B]	[C]	[D]	[E]	[F]	[G]
Description	Refers to the contributor's background or line of work.	Refers to the contributor's affiliation	Refers to the contributor's email address.	If the data has been published in a peer-reviewed article, report, or EPD, please select Yes, else No.	If the data has been published, then the name of the corresponding author should be entered here.	If the data has been published, then the publication title should be entered here.	If the data has been published, then the publication link should be entered here.
Data Entry Type:	Select from the below-mentioned 'predefined options' <input type="checkbox"/> Researcher/ PhD Scholar <input type="checkbox"/> Material manufacturer <input type="checkbox"/> EPD or LCA consultant <input type="checkbox"/> Govt. official <input type="checkbox"/> Other**  If the Contributor's background does not match the options, they should select 'Other' and proceed to type out their background.	Alphanumeric  Enter the organization the Contributor is affiliated with.	Alphanumeric  Enter an operational email address where the Contributor can be reached.	Select from the below-mentioned 'predefined options' <input type="checkbox"/> Yes <input type="checkbox"/> No	Alphanumeric  Enter the name of the corresponding author here.	Alphanumeric  Enter the publication title here.	Alphanumeric  Enter the publication link here.
Note — [D] – Please note that if [D] is marked as 'No,' then [E], [F], and [G] will remain empty/ blank. On the other hand, if [D] is marked as 'Yes' and the publication mentions an organization as the author, the same can be entered in [E]. Also, if [D] is marked as 'Yes' and the article/report is in the process of getting published, [G] should be left blank.							

**Table 30 Construction Material Details**  
(Clause E-1)

<b>Column Headers</b>	<b>Final Construction Material*</b>	<b>Type/ Category*</b>	<b>Brand*</b>	<b>Product Name*</b>	<b>Material Specifications*</b>
	<b>[H]</b>	<b>[I]</b>	<b>[J]</b>	<b>[K]</b>	<b>[L<sub>01</sub> – L<sub>100</sub>]</b>
<b>Description</b>	Refers to the material for which data is being collected.	This field refers to the further classification of the material based on its specifications/ raw material variation/ purpose etc.	Refers to the manufacturer/ brand of the material.	Refers to the name of the product as mentioned on the catalogue/ package.	Refers to the material specifications.
<b>Data Entry Type</b>	Select from the below mentioned 'predefined options' mentioned in <b>Error! Reference source not found.1**</b>  If the material is not covered in the options, the Contributor should proceed to type it out.	Select from the 'predefined options' mentioned in <b>Error! Reference source not found.1**</b>  If the type is not covered in the options, the Contributor should proceed to type it out.	Alphanumeric  Enter the manufacturer/ brand name here.	Alphanumeric  Enter the product name here.	Alphanumeric  The material specifications corresponding to the relevant materials are mentioned in <b>Error! Reference source not found.1</b>
<p><b>NOTE — [J] – Please note that for all materials except sand, the material manufacturer or brand, and not the material supplier, should be entered in [J]. Materials like sand and aggregate are recognized by the river and quarry from where they are mined; the contributor is encouraged to mention the name of the respective river basin and quarry in [J] along with the manufacturer/Supplier.</b></p>					

**Table 11 Finished Construction Materials, Their Types, and Specifications**  
(Clause E-1)

Finished Construction Material	Type/Category		Material Specifications
Cement	Ordinary Portland cement (OPC) Portland pozzolana cement (PPC) Rapid-hardening cement Extra-rapid-hardening cement Quick-setting cement Low heat cement Sulphate resisting cement Blast furnace slag cement	High-alumina cement White cement Coloured cement Air-entraining cement Expansive cement Hydrographic cement Portland -limestone cement (PLC) Limestone calcined clay cement (LC3)	Raw material proportion [L <sub>01</sub> ] Density (kg/m <sup>3</sup> ) [L <sub>02</sub> ] 28-Day compressive strength (N/m <sup>2</sup> ) [L <sub>03</sub> ]
Sand	Natural (river) sand M-Sand Concrete Sand	Pit Sand (coarse sand) M-Sand	Density (kg/m ) [L <sub>02</sub> ] Specific gravity [L <sub>04</sub> ] Zone [L <sub>05</sub> ]
Aggregate	Smaller than 10 mm between 10 and 20 mm	between 20 and 40 mm	Density (kg/m <sup>3</sup> ) [L <sub>02</sub> ] Specific gravity [L <sub>04</sub> ]
Steel (Rebar)	Mild steel bar Carbon steel bar Stainless steel bar	Thermo-mechanically treated (TMT) bar Cold rolled steel bar Twisted steel bar	Diameter (mm) [L <sub>06</sub> ] Grade [L <sub>07</sub> ] Yield Strength (N/m <sup>2</sup> ) [L <sub>08</sub> ] Tensile Strength (N/m <sup>2</sup> ) [L <sub>09</sub> ]
Structural Steel	Carbon steel High-strength low-alloy steel	Forged steel Quenched and tempered alloy steel	Grade [L <sub>07</sub> ] Yield strength (N/m <sup>2</sup> ) [L <sub>08</sub> ] Tensile strength (N/m <sup>2</sup> ) [L <sub>09</sub> ]
Bricks/Blocks	Burnt clay bricks Flyash bricks Autoclaved aerated concrete (AAC) blocks	Rammed earth blocks Laterite blocks Compressed stabilized earth (CSEB) blocks	Dimensions – L*B (m <sup>2</sup> ) [L <sub>10</sub> ] Thickness (mm) [L <sub>11</sub> ] Density (kg/m <sup>3</sup> ) [L <sub>02</sub> ]

Finished Construction Material	Type/Category		Material Specifications
			Compressive strength (N/m <sup>2</sup> ) [L <sub>03</sub> ] U-Value (W/m <sup>2</sup> ·K) [L <sub>12</sub> ]
Paint	Oil paint. Emulsion paint. Enamel paint. Bituminous paint.	Aluminium paint. Anti-Corrosive paint. Synthetic rubber paint. Cement paint	Coverage (m <sup>2</sup> ) [L <sub>13</sub> ]
Tiles	Ceramic tile Porcelain tile Marble tile	Cement tile Granite tile	Dimensions – L*B (m <sup>2</sup> ) [L <sub>10</sub> ] Thickness (mm) [L <sub>11</sub> ]

**Table 32 Metadata**  
(Clause E-1)

Column Headers	Data Type*	Data Aggregation Level*	Data Review by Third Party	Data Collection Beginning*	Data Collection Ending*	Data Availability Level*	Final Construction Material Qty.	Final Construction Material Unit	Final Construction Material Qty. (kg)
	[M]	[N]	[O]	[P]	[Q]	[R]	[S]	[T]	[U]
Description	Refers to the nature of the data – Whether it was measured or estimated. Measured data refers to data that was monitored by means of	Refers to the level of aggregation of the reported data. If a contributor can provide individual measurements, then the data is said to be unaggregated. If the contributor	Indicates whether the data has been reviewed by a third party or not.	Refers to the date when data collection began, expressed as 'dd-mmm-yyy'	Refers to the date when data collection ended, expressed as 'dd-mmm-yyyy'	Refers to the lifecycle stages for which data is available and being reported.	Refers to the qty. of finished construction material for which the embodied energy and carbon data is being reported.	Refers to the unit in which the finished construction material qty. is expressed.	Refers to the qty. of the finished construction material, as expressed in kg.

Column Headers	Data Type*	Data Aggregation Level*	Data Review by Third Party	Data Collection Beginning*	Data Collection Ending*	Data Availability Level*	Final Construction Material Qty.	Final Construction Material Unit	Final Construction Material Qty. (kg)
	[M]	[N]	[O]	[P]	[Q]	[R]	[S]	[T]	[U]
	equipment records or similar methods. Estimated data are based on the best professional judgment or other educated guesses.	has collected data for months or a year, then the data is said to be temporally averaged. Moreover, if the data is representative of a single plant or all manufacturing plants owned by the contributor, the data is said to be spatially averaged.							
Data Entry Type	Select from the below-mentioned 'predefined options' <input type="checkbox"/> Measured <input type="checkbox"/> Estimated	Select one or more from the below-mentioned 'predefined options' <input type="checkbox"/> Individual measured - Unaggregated data	Select from the below-mentioned 'predefined options'	Numeric Enter the date of data collection commencement here.	Numeric Enter the date of data collection ending here.	Select one or more from the below-mentioned 'predefined options' <input type="checkbox"/> A1 <input type="checkbox"/> A2	Numeric Enter the qty. of finished construction material here.	Select from the below-mentioned 'predefined options' <input type="checkbox"/> kg <input type="checkbox"/> MT <input type="checkbox"/> m <sup>3</sup> <input type="checkbox"/> m <sup>2</sup>	Numeric Enter the qty. of finished construction material here.

Column Headers	Data Type*	Data Aggregation Level*	Data Review by Third Party	Data Collection Beginning*	Data Collection Ending*	Data Availability Level*	Final Construction Material Qty.	Final Construction Material Unit	Final Construction Material Qty. (kg)
	[M]	[N]	[O]	[P]	[Q]	[R]	[S]	[T]	[U]
		<input type="checkbox"/> Temporal averages (monthly OR annual) <input type="checkbox"/> Spatial averages (single plant OR all plants) <input type="checkbox"/> Normalized value (per kg of material)	<input type="checkbox"/> Yes <input type="checkbox"/> No			<input type="checkbox"/> A3 <input type="checkbox"/> A1-A3		<input type="checkbox"/> Litres <input type="checkbox"/> Nos.	

**Table 33 Relevant fields for Raw Material Extraction -A1 lifecycle stage (1)**

(Clause E-1)



Column Headers	Sr. No.*	Raw Material*+	Raw Material Qty.*	Raw Material Unit*	Raw Material Extraction Status*	Raw Material Supplier/Manufacturer*	Raw Material Extraction Process
	[AA]	[AA1]	[BA1]	[CA1]	[DA1]	[EA1]	[FA1]
Description	Refers to the chronological order of raw material	Refers to the raw material(s) used up for producing the finished construction material.	Refers to the qty. Of raw material(s) needed/ extracted for producing the mentioned qty. of finished construction material.	Refers to the unit in which raw material qty. is being expressed.	Refers to the status of raw material extraction. Was it extracted by the contributor, or was it purchased from a supplier?	If the raw material was purchased from a supplier, then the name of the supplier shall be entered in this field.	Refers to the processes involved in mining/ extracting the raw materials. The contributor is encouraged to mention all the processes.
Data Entry Type	Numeric  Starting from 01, 02, and so on, the Contributor should number the raw materials.	Alphanumeric  Enter the raw materials here.	Numeric  Enter the qty. of the respective raw material(s) here.	Select from the below-mentioned 'predefined options' <input type="checkbox"/> kg <input type="checkbox"/> MT <input type="checkbox"/> m <sup>3</sup> <input type="checkbox"/> m <sup>2</sup> <input type="checkbox"/> Litres <input type="checkbox"/> Nos.	Select from the below-mentioned 'predefined options' <input type="checkbox"/> Self-extracted <input type="checkbox"/> Bought from Supplier	Alphanumeric  Enter the name of the raw material supplier here.	Alphanumeric  Enter the raw material extraction processes here.

**NOTES**

1) [AA1] – Please note that every raw material will need to be entered in a separate, new row.

2) [DA1] – Importantly, the Contributor can indicate whether the Raw Material was extracted by them or bought from a Supplier. In the case of Raw Material being bought from a Supplier, the Contributor is encouraged to ask the Supplier for the Embodied Energy and carbon impacts incurred till the Raw Material reaches the Contributor.

**Table 34 Relevant fields for Raw Material Extraction -A1 Lifecycle Stage (2)**

*(Clause E-1)*

Column Headers	Raw Material Extraction Site Latitude	Raw Material Extraction Site Longitude	Raw Material Extraction State*	Raw Material Extraction District*	Fuel Mix*	Fuel Qty.*	Fuel Unit*
	[GA1]	[HA1]	[IA1]	[JA1]	[KA1]	[LA1]	[MA1]
Description	Refers to the latitude of the raw material extraction site.	Refers to the longitude of the raw material extraction site.	Refers to the state in which the raw material was extracted.	Refers to the district in which the raw material was extracted.	Refers to the fuels used during the extraction process. The contributor is encouraged to mention all fuels. In case of more than one fuel, each new fuel shall be added as new rows.	Refers to the qty. of the fuel.	Refers to the unit in which fuel qty. is expressed.
Data Entry Type	Numeric Enter the latitude here.	Numeric Enter the longitude here.	Alphanumeric Enter the name of the State here.	Alphanumeric Enter the name of the district here.	Select from the below-mentioned 'predefined options' <input type="checkbox"/> Grid Electricity <input type="checkbox"/> Petrol <input type="checkbox"/> Diesel <input type="checkbox"/> Coal <input type="checkbox"/> Wood <input type="checkbox"/> Solar Energy <input type="checkbox"/> Hydro- Energy <input type="checkbox"/> Wind Energy <input type="checkbox"/> Thermal Energy	Numeric Enter the fuel qty. here.	Select from the below-mentioned 'predefined options' <input type="checkbox"/> kWh <input type="checkbox"/> MJ <input type="checkbox"/> Litres <input type="checkbox"/> kg <input type="checkbox"/> MT

**Table 35 Relevant fields for Raw Material Extraction -A1 Lifecycle Stage (3)**  
 (Clause E-1)

Column Headers	Fuel density* (kg/m <sup>3</sup> )	Fuel Calorific Value Type	Fuel Calorific Value*	Fuel Calorific Value Unit*	Embodied Energy*	Embodied Energy Unit*
	[NA1]	[OA1]	[PA1]	[QA1]	[RA1]	[SA1]
Description	Refers to the density of the fuel expressed in kg/m <sup>3</sup> .	Refers to the type of calorific value of the fuel. Is it a net-value or a gross-value?	Refers to the calorific value of the fuel.	Refers to the unit in which the fuel's calorific value is expressed.	Refers to the embodied energy released during the raw material extraction process.	Refers to the unit in which embodied energy is expressed.
Data Entry Type	Numeric Enter the fuel density here.	Select from the below-mentioned 'predefined options' <input type="checkbox"/> Net calorific value <input type="checkbox"/> Gross calorific value	Numeric Enter the fuel calorific value here.	Select from the below-mentioned 'predefined options' <input type="checkbox"/> kJ/kg <input type="checkbox"/> MJ/kg <input type="checkbox"/> kcal/kg	Numeric Enter the Embodied Energy value here.	Select from the below-mentioned 'predefined options' <input type="checkbox"/> kWh <input type="checkbox"/> MJ

**Table 36 Relevant fields for Raw Material Extraction -A1 Lifecycle Stage (4)**

(Clause E-1)

Column Headers	Characterization Factor	Characterization Factor Unit	Embodied Carbon*	Embodied Carbon Unit*
	[TA1]	[UA1]	[VA1]	[WA1]
Description	Refers to the characterization factor that can be multiplied with the embodied energy to convert it into embodied carbon.	Refers to the unit in which the characterization factor is expressed.	Refers to the embodied carbon released during raw material extraction processes.	Refers to the unit in which embodied carbon is expressed.
Data Entry Type	Numeric  Enter the characterization factor here.	Select from the below-mentioned 'predefined options' <input type="checkbox"/> kg CO <sub>2</sub> /kWh <input type="checkbox"/> kg CO <sub>2</sub> /MJ <input type="checkbox"/> kg CO <sub>2e</sub> /kWh <input type="checkbox"/> kg CO <sub>2e</sub> /MJ	Numeric  Enter the embodied carbon value here.	Select from the below-mentioned 'predefined options' <input type="checkbox"/> kg CO <sub>2</sub> <input type="checkbox"/> kg CO <sub>2e</sub>

**Table 37 Relevant Fields for Transportation between Raw Material Extraction Site and Finished Material Manufacturing Plant -A2 Lifecycle Stage (1)**  
(Clause E-1)

Column Headers	Sr. No.*	Raw Material*	Raw Material Qty.*	Raw Material Unit*	Manufacturing Site Latitude	Manufacturing Site Longitude	Manufacturing Site State*	Manufacturing Site District*	Transportation Modes*
	[AA]	[AA1]	[BA1]	[CA1]	[AA2]	[BA2]	[CA2]	[DA2]	[EA2]
Description	Refers to the chronological order of raw material	Refers to the raw material(s) used up for producing the finished construction material.	Refers to the qty. Of raw material(s) needed/ extracted for producing the	Refers to the unit in which raw material qty. is being expressed.	Refers to the latitude of the material manufacturing plant site.	Refers to the longitude of the material manufacturing plant site.	Refers to the state in which the material manufacturing plant is located.	Refers to the district in which the material manufacturing plant is located.	Refers to the various modes of transport.

			mentioned qty. Of finished constructio n material.						
Data Entry Type	Numeric  Starting from 01, 02, and so on, the contributor should number the raw materials.	Alphanumeric  Enter the raw materials here.	Numeric  Enter the qty. of the respective raw material(s) here.	Select from the below- mentione d 'predefine d options' <input type="checkbox"/> kg <input type="checkbox"/> MT <input type="checkbox"/> m <sup>3</sup> <input type="checkbox"/> m <sup>2</sup> <input type="checkbox"/> Litres <input type="checkbox"/> Nos.	Numeric  Enter the latitude here.	Numeric  Enter the longitude here.	Alphanumeric  Enter the name of the state here.	Alphanumeric  Enter the name of the district here.	Select from the below- mentioned 'predefined options' <input type="checkbox"/> Road <input type="checkbox"/> Air <input type="checkbox"/> Rail <input type="checkbox"/> Water

NOTE — [AA], [AA1], [BA1], [CA1] details can be copied from the A1 data sheet.

**Table 38 Relevant fields for Transportation between Raw Material Extraction Site and Finished Material  
Manufacturing Plant -A2 Lifecycle Stage (2)  
(Clause E-1)**

Column Headers	Distance between Extraction Site and Manufacturing Plant* (km)	Vehicle Category*+	Vehicle Capacity* (Tonne)	Vehicle – Make*	Vehicle – Model*	No. of trips*	Total distance travelled for transporting Raw Material* (km)
	[FA2]	[GA2]	[HA2]	[IA2]	[JA2]	[KA2]	[LA2]
Description	Refers to the distance between the raw material extraction site and the material manufacturing plant, expressed in km.	Refers to the category of vehicle used for transportation.	Refers to the vehicle's capacity, expressed in tonnes.	Indicates the manufacturer of the transport vehicle.	Indicates the model name of the transport vehicle.	Refers to the no. Of trips it takes to transport the mentioned qty. of raw material from the extraction site to the manufacturing plant. It shall be calculated by dividing the raw material qty. By the distance between the raw material extraction point and the manufacturing plant.	Refers to the total distance travelled for transporting the raw material between extraction and manufacturing plant. It shall be calculated by multiplying [ea2] and [ja2].
Data Entry Type	Numeric  Enter the distance here.	Select from the below-mentioned 'predefined options' <input type="checkbox"/> Light Duty Vehicle (LDV) <input type="checkbox"/> Medium Duty Vehicle (MDV) <input type="checkbox"/> Heavy Duty Vehicle (HDV)	Numeric  Enter the vehicle's capacity here.	Alphanumeric  Enter the vehicle manufacturer's name here.	Alphanumeric  Enter the vehicle's model name here.	Numeric  Enter the no. of trips here.	Numeric  Enter the distance here.

NOTE — [FA2] In case of more than one transportation mode, the Contributor may enter the details of each transportation mode/vehicle in new, separate rows.

**Table 39 Relevant fields for Transportation between Raw Material Extraction Site and Finished Material**

**Manufacturing Plant -A2 Lifecycle Stage (3)**

*(Clause E-1)*



Column Headers	Fuel Mix*	Fuel Qty.*	Fuel Unit*	Fuel density* (kg/m <sup>3</sup> )	Fuel Calorific Value Type	Fuel Calorific Value*	Fuel Calorific Value Unit*
	[MA2]	[NA2]	[OA2]	[PA2]	[QA2]	[RA2]	[SA2]
Description	Refers to the fuels used for transporting the raw materials between the extraction site and manufacturing plant. The contributor is encouraged to mention all fuels. In case of more than one fuel, each new fuel shall be added as new rows.	Refers to the qty. Of the fuel.	Refers to the unit in which fuel qty. Is expressed.	Refers to the density of the fuel expressed in kg/m <sup>3</sup> .	Refers to the type of calorific value of the fuel. Is it a net-value or a gross-value?	Refers to the calorific value of the fuel.	Refers to the unit in which fuel's calorific value is expressed.
Data Entry Type	Select from the below-mentioned 'predefined options' <input type="checkbox"/> Grid Electricity <input type="checkbox"/> Petrol <input type="checkbox"/> Diesel <input type="checkbox"/> Coal	Numeric  Enter the fuel qty. here.	Select from the below-mentioned 'predefined options' <input type="checkbox"/> kWh <input type="checkbox"/> MJ <input type="checkbox"/> Litres <input type="checkbox"/> kg <input type="checkbox"/> MT	Numeric  Enter the fuel density here.	Select from the below-mentioned 'predefined options' <input type="checkbox"/> Net Calorific Value <input type="checkbox"/> Gross Calorific Value	Numeric  Enter the fuel calorific value here.	Select from the below-mentioned 'predefined options' <input type="checkbox"/> kJ/kg <input type="checkbox"/> MJ/kg <input type="checkbox"/> kcal/kg

**Table 40 Relevant Fields for Transportation between Raw Material Extraction Site and Finished Material Manufacturing Plant -A2 Lifecycle Stage (4)**  
(Clause E-1)

<b>Column Headers</b>	<b>Embodied Energy*</b>	<b>Embodied Energy Unit*</b>	<b>Characterization Factor</b>	<b>Characterization Factor Unit</b>	<b>Embodied Carbon**</b>	<b>Embodied Carbon Unit*</b>
	<b>[TA2]</b>	<b>[UA2]</b>	<b>[VA2]</b>	<b>[WA2]</b>	<b>[XA2]</b>	<b>[YA2]</b>
<b>Description</b>	Refers to the embodied energy released towards transporting the raw materials between the extraction site and manufacturing plant.	Refers to the unit in which embodied energy is expressed.	Refers to the characterization factor that can be multiplied with the embodied energy to convert it into embodied carbon.	Refers to the unit in which the characterization factor is expressed.	Refers to the embodied carbon released during raw material extraction processes.	Refers to the unit in which embodied carbon is expressed.
<b>Data Entry Type</b>	Numeric  Enter the Embodied Energy value here.	Select from the below mentioned 'predefined options' <input type="checkbox"/> kWh <input type="checkbox"/> MJ	Numeric  Enter the Characterization Factor here.	Select from the below mentioned 'predefined options' <input type="checkbox"/> kg CO <sub>2</sub> /kWh <input type="checkbox"/> kg CO <sub>2</sub> /MJ <input type="checkbox"/> kg CO <sub>2e</sub> /kwh <input type="checkbox"/> kg CO <sub>2e</sub> /MJ	Numeric  Enter the Embodied Carbon value here.	Select from the below mentioned 'predefined options' <input type="checkbox"/> kg CO <sub>2</sub> <input type="checkbox"/> kg CO <sub>2e</sub>

**Table 41 Relevant Fields for Manufacturing -A3 Lifecycle Stage (1)**

*(Clause E-1)*

<b>Column Headers</b>	<b>Plant Capacity*</b>	<b>Plant Standard Operation Temperature (°C)</b>	<b>Plant Standard Operation Pressure (Pa)</b>	<b>Feedstock Material Quality*</b>
	<b>[AA3]</b>	<b>[BA3]</b>	<b>[CA3]</b>	<b>[DA3]</b>
<b>Description</b>	Refers to the capacity of the manufacturing plant. The contributor should provide a written description of all the materials produced at the plant along with the quantities that can be produced monthly or annually.	Refers to the standard operating temperature of the plant, expressed in °c.	Refers to the standard operating pressure of the plant, expressed in pa.	Refers to the quality of the input/ feedstock material. The contributor is encouraged to provide a description of the feedstock material.  For example, copper ore 13 percent vs. copper ore 5 percent.
<b>Data Entry Type</b>	Alphanumeric  Enter the plant capacity here.	Numeric  Enter the standard operating temperature of the plant here.	Numeric  Enter the standard operating pressure of the plant here.	Alphanumeric  Enter the description of the feedstock material quality here.
NOTE — [DA3] – The Contributor is encouraged to enter this detail for all Raw Materials.				

**Table 42 Relevant Fields for Manufacturing - A3 Lifecycle Stage (2)**

*(Clause E-1)*

Column Headers	Sr. No.*	Raw Material*+	Raw Material Qty.*	Raw Material Unit*	Processes for preparing Raw Materials for Manufacturing*+	Technology for manufacturing Finished Construction Material*+
	[AA]	[AA1]	[BA1]	[CA1]	[EA3]	[FA3]
Description	Refers to the chronological order of raw material	Refers to the raw material(s) used up for producing the finished construction material.	Refers to the qty. Of raw material(s) needed/ extracted for producing the mentioned qty. of finished construction material.	Refers to the unit in which raw material qty. is being expressed.	Refers to the processes for preparing the raw materials for the final manufacturing process. The contributor is encouraged to provide data pertaining to all preparatory processes.	Refers to the technology and processes used for manufacturing the final construction material. The contributor is encouraged to provide data pertaining to all manufacturing processes.
Data Entry Type	Numeric  Starting from 01, 02, and so on, the Contributor should number the raw materials	Alphanumeric  Enter the raw materials here.	Numeric  Enter the qty. of the respective raw material(s) here.	Select from the below-mentioned 'predefined options' <input type="checkbox"/> kg <input type="checkbox"/> MT <input type="checkbox"/> m <sup>3</sup> <input type="checkbox"/> m <sup>2</sup> <input type="checkbox"/> Litres <input type="checkbox"/> Nos.	Alphanumeric  Enter the preparatory processes here.	Alphanumeric  Enter the manufacturing processes here.

**NOTES**

- 1) [AA], [AA1], [BA1], [CA1] details can be copied from the A1 data sheet.
- 2) [EA3] and [FA3] – If data is available for individual preparatory processes and/or manufacturing processes, the contributor may enter the data for each process in new, separate rows. Otherwise, all processes can be written in one row separated by commas.

**Table 43 Relevant Fields for Manufacturing - A3 Lifecycle Stage (3)**

(Clause E-1)

Column Headers	Fuel Mix*	Fuel Qty.*	Fuel Unit*	Fuel density* (kg/m <sup>3</sup> )	Fuel Calorific Value Type	Fuel Calorific Value*	Fuel Calorific Value Unit*
	[GA3]	[HA3]	[IA3]	[JA3]	[KA3]	[LA3]	[MA3]
Description	Refers to the fuels used for the manufacturing process. The contributor is encouraged to mention all fuels. In case of more than one fuel, each new fuel shall be added as new rows.	Refers to the qty. of the fuel.	Refers to the unit in which fuel qty. is expressed.	Refers to the density of the fuel expressed in kg/m <sup>3</sup> .	Refers to the type of calorific value of the fuel. Is it a net-value or a gross-value?	Refers to the calorific value of the fuel.	Refers to the unit in which fuel's calorific value is expressed.
Data Entry Type	Select from the below-mentioned 'predefined options' <input type="checkbox"/> Grid Electricity <input type="checkbox"/> Petrol <input type="checkbox"/> Diesel <input type="checkbox"/> Coal	Numeric  Enter the fuel qty. here.	Select from the below-mentioned 'predefined options' <input type="checkbox"/> kWh <input type="checkbox"/> MJ <input type="checkbox"/> Litres <input type="checkbox"/> kg <input type="checkbox"/> MT	Numeric  Enter the fuel density here.	Select from the below-mentioned 'predefined options' <input type="checkbox"/> Net Calorific Value <input type="checkbox"/> Gross Calorific Value	Numeric  Enter the fuel calorific value here.	Select from the below-mentioned 'predefined options' <input type="checkbox"/> kJ/kg <input type="checkbox"/> MJ/kg <input type="checkbox"/> kcal/kg

**Table 44 Relevant Fields for Manufacturing -A3 Lifecycle Stage (4)**  
(Clause E-1)

<b>Column Headers</b>	<b>Embodied Energy*</b>	<b>Embodied Energy Unit*</b>	<b>Characterization Factor</b>	<b>Characterization Factor Unit</b>	<b>Embodied Carbon*</b>	<b>Embodied Carbon Unit*</b>
	<b>[NA3]</b>	<b>[OA3]</b>	<b>[PA3]</b>	<b>[QA3]</b>	<b>[RA3]</b>	<b>[SA3]</b>
<b>Description</b>	Refers to the embodied energy released during the manufacturing process.	Refers to the unit in which embodied energy is expressed.	Refers to the characterization factor that can be multiplied with the embodied energy to convert it into embodied carbon.	Refers to the unit in which the characterization factor is expressed.	Refers to the embodied carbon released during the manufacturing process.	Refers to the unit in which carbon is expressed.
<b>Data Entry Type</b>	Numeric Enter the Embodied Energy value here.	Select from the below-mentioned 'predefined options' <input type="checkbox"/> kWh <input type="checkbox"/> MJ	Numeric Enter the Characterization Factor here.	Select from the below-mentioned 'predefined options' <input type="checkbox"/> kg CO <sub>2</sub> /kWh <input type="checkbox"/> kg CO <sub>2</sub> /MJ <input type="checkbox"/> kg CO <sub>2</sub> e/kwh <input type="checkbox"/> kg CO <sub>2</sub> e/MJ	Numeric Enter the Embodied Carbon value here.	Select from the below-mentioned 'predefined options' <input type="checkbox"/> kg CO <sub>2</sub> <input type="checkbox"/> kg CO <sub>2</sub> e

**Table 45 Relevant Fields for Composite A1-A3 Lifecycle Stage**  
(Clause E-1)

Column Headers	Embodied Energy*	Embodied Energy Unit*	Embodied Energy Per kg*	Characterization Factor	Characterization Factor Unit	Embodied Carbon*	Embodied Carbon Unit*	Embodied Carbon per kg*
	[AA <sub>1-3</sub> ]	[BA <sub>1-3</sub> ]	[CA <sub>1-3</sub> ]	[DA <sub>1-3</sub> ]	[EA <sub>1-3</sub> ]	[FA <sub>1-3</sub> ]	[GA <sub>1-3</sub> ]	[HA <sub>1-3</sub> ]
Description	Refers to the embodied energy released during the raw material extraction process.	Refers to the unit in which embodied energy is expressed.	Refers to the embodied energy per kg of material.	Refers to the characterization factor that can be multiplied with the embodied energy to convert it into embodied carbon.	Refers to the unit in which the characterization factor is expressed.	Refers to the embodied carbon released during raw material extraction processes.	Refers to the unit in which embodied carbon is expressed.	Refers to the embodied carbon per kg of material.
Data Entry Type	Numeric  Enter the Embodied Energy value here.	Select from the below-mentioned 'predefined options' <input type="checkbox"/> kWh <input type="checkbox"/> MJ	Numeric  Enter the Embodied Energy value here.	Numeric  Enter the Characterization Factor here.	Select from the below-mentioned 'predefined options' <input type="checkbox"/> kg CO <sub>2</sub> /kWh <input type="checkbox"/> kg CO <sub>2</sub> /MJ <input type="checkbox"/> kg CO <sub>2</sub> e/kwh <input type="checkbox"/> kg CO <sub>2</sub> e/MJ	Numeric  Enter the Embodied Carbon value here.	Select from the below-mentioned 'predefined options' <input type="checkbox"/> kg CO <sub>2</sub> <input type="checkbox"/> kg CO <sub>2</sub> e	Numeric  Enter the Embodied Carbon value here.
NOTE — [CA <sub>1-3</sub> ] and [HA <sub>1-3</sub> ] – These values can be calculated by dividing the cumulative A1-A3 embodied energy or carbon by the weight of the finished construction material.								

**LIST OF STANDARDS**

The following list records those standards which are acceptable as 'good practice' and 'accepted standards' in the fulfilment of the requirements of the Code. The standards listed may be used by the Authority for conformance with the requirements of the referred clauses in the Code.

In the following list, the number appearing in the first column within parameters indicates the number of reference in this Part.

	<i>IS No.</i>	<i>Title</i>
(1)	15792 : 2002	Guidelines for artificial recharge to ground water
	15797 : 2008	Guidelines for roof top rainwater harvesting
(2)	3792 : 1978	Guide for heat insulation of non-industrial buildings ( <i>first revision</i> )
(3)	456 : 2000	Code of practice for plain and reinforced concrete ( <i>fourth revision</i> )
(4)	4926 : 2003	Code of practice for ready-mixed concrete ( <i>third revision</i> )
(5)	455 : 2015	Specification for Portland Slag cement ( <i>fifth revision</i> )
	456 : 2000	Code of practice for plain and reinforced concrete ( <i>fourth revision</i> )
	457 : 1957	Code of practice for general construction of plain and reinforced concrete for dams and other massive structures
	458 : 2021	Specification for precast concrete pipes (with and without reinforcement) ( <i>fifth revision</i> )
	459 : 1992	Specification for unreinforced corrugated and semi-corrugated asbestos cement sheets ( <i>third revision</i> )
	1332 : 1986	Specification for precast reinforced concrete steel lighting poles ( <i>first revision</i> )
	1343 : 2012	Code of practice for prestressed concrete ( <i>second revision</i> )
	1489	Specification for Portland-pozzolana cement:
	(Part 1) : 2015	Fly ash based ( <i>fourth revision</i> )
	(Part 2) : 2015	Calcined clay based ( <i>fourth revision</i> )
	1592 : 2003	Specification for asbestos cement pressure pipes and joints ( <i>fourth revision</i> )



1626	Specification for asbestos cement building pipes and pipe fittings, gutters and gutter fittings and roofing fittings:
(Part 1) : 1994	Pipe and pipe fittings ( <i>second revision</i> )
(Part 2) : 1994	Gutters and gutter fittings ( <i>second revision</i> )
(Part 3) : 1994	Roofing accessories ( <i>second revision</i> )
1727 : 1967	Methods of test for pozzolanic materials ( <i>first revision</i> )
2096 : 1992	Specification for asbestos cement flat sheets
2098 : 1997	Specification for asbestos cement building boards
2117 : 1991	Guide for manufacture of hand-made common burnt clay building bricks ( <i>second revision</i> )
2185	Specification for concrete masonry units :
(Part 1) : 2005	Hollow and solid concrete blocks ( <i>third revision</i> )
(Part 2) : 1983	Hollow and solid light-weight concrete blocks ( <i>first revision</i> )
(Part 3) : 1984	Autoclaved cellular aerated, concrete blocks ( <i>first revision</i> )
(Part 4) : 2008	Preformed foam cellular concrete blocks
2541 : 1991	Code of practice for preparation and use of lime concrete ( <i>second revision</i> )
3115 : 1992	Specification for lime based blocks ( <i>second revision</i> )
<b>3370</b>	<b>Concrete Structures for Retaining Aqueous Liquids - Code of Practice:</b>
<b>(Part 1) : 2021</b>	<b>General requirements (<i>second revision</i>)</b>
<b>(Part 2) : 2021</b>	<b>Plain and Reinforced Concrete Structures (<i>second revision</i>)</b>
3466 : 1988	Specification for masonry cement ( <i>second revision</i> )
3812	Specification for pulverized fuel ash:
(Part 1) : 2013	For use as Pozzolana in cement, cement mortar and concrete ( <i>third revision</i> )
(Part 2) : 2013	For use as admixture in cement mortar and concrete ( <i>third revision</i> )
4098 : 1983	Specification for lime-pozzolana mixture ( <i>first revision</i> )
4139 : 1989	Specification for calcium silicate bricks ( <i>second revision</i> )
4926 : 2003	Code of practice for ready-mixed concrete ( <i>second revision</i> )
5817 : 1992	Code of practice for preparation and use of lime pozzolana mixture concrete in buildings and roads ( <i>first revision</i> )
5820 : 1970	Specification for precast concrete cable cover

6041 : 1985	Code of practice for construction of autoclaved cellular concrete block masonry ( <i>first revision</i> )
6042 : 1969	Code of practice for construction of lightweight concrete block masonry
6066 : 1994	Recommendations for pressure grouting of rock foundations in river valley projects ( <i>second revision</i> )
<b>6072 : 2023</b>	<b>Autoclaved reinforced cellular concrete wall slabs Specifications (<i>first revision</i>)</b>
6073 : 2006	Specification for autoclaved reinforced cellular concrete floor and roof slabs ( <i>first revision</i> )
6908 : 1991	Specification for asbestos cement pipes and fittings for sewerage and drainage
8229 : 1986	Specification for oil well cement ( <i>first revision</i> )
<b>9142</b>	<b>Artificial lightweight aggregate for concrete - Specification</b>
<b>(Part 1) : 2018</b>	<b>Part 1 for concrete masonry blocks and for applications other than for structural concrete (<i>first revision</i>)</b>
<b>(Part 2) : 2018</b>	<b>Part 2 sintered fly ash coarse aggregate (<i>first revision</i>)</b>
9375 : 1979	Specification for precast reinforced concrete plant guards
9627 : 1980	Specification for asbestos cement pressure pipes (light duty)
9872 : 1981	Specification for precast concrete septic tanks
9893 : 1981	Specification for precast concrete lintels and sills
10049 : 1981	Code of practice for manufacture of lime based blocks
<b>10262 : 2019</b>	<b>Concrete Mix Proportioning — Guidelines (<i>second revision</i>)</b>
10359 : 1982	Code of practice for manufacture and use of lime-pozzolana concrete blocks for paving
10360 : 1982	Specification for lime-pozzolana concrete blocks for paving
10772 : 1983	Specification for quick setting lime-pozzolana mixture
<b>11293 : 2018</b>	<b>Guidelines for the design of grout curtains for earth and rock fill dams, masonry dams and concrete gravity dams</b>
11650 : 1991	Guide for manufacture of common burnt clay building bricks by semi-mechanized process ( <i>first revision</i> )
12089 : 1987	Specification for granulated slag for manufacture of Portland slag cement
12440 : 1988	Specification for precast concrete stone masonry blocks

	12592 : 2002	Specification for precast concrete manhole cover and frame
	12894 : 2002	Specification for pulverized fuel ash lime bricks ( <i>first revision</i> )
	13000 : 1990	Specification for silica-asbestos cement flat sheets
	13008 : 1990	Specification for shallow corrugated asbestos cement sheets
	13757 : 1993	Specification for burnt clay fly ash building bricks
	14862 : 2000	Specification for fibre cement flat sheets
	14871 : 2000	Specification for products in fibre reinforced cement - long corrugated or asymmetrical section sheet and fittings for roofing and cladding
	15388 : 2003	Specification for silica fume
	15648 : 2006	Specification for pulverized fuel ash for lime pozzolana mixture application
	15916 : 2020	Building Design and Erection Using Prefabricated Concrete - Code of Practice ( <i>first revision</i> )
	15917 : 2020	Building Design and Erection Using Mixed / Composite Construction - Code of Practice ( <i>first revision</i> )
(6)	2686 : 1977	Specification for cinder as fine aggregates for use in lime concrete ( <i>first revision</i> )
	3068 : 1986	Specification for broken brick (burnt clay) coarse aggregates for use in lime concrete ( <i>second revision</i> )
	3182 : 1986	Specification for broken brick (burnt clay) fine aggregates for use in lime mortar ( <i>second revision</i> )
	9142	Artificial lightweight aggregate for concrete - Specification
	(Part 1) : 2018	Part 1 for concrete masonry blocks and for applications other than for structural concrete ( <i>first revision</i> )
	(Part 2) : 2018	Part 2 sintered fly ash coarse aggregate ( <i>first revision</i> )
(7)	9142	Artificial lightweight aggregate for concrete - Specification
	(Part 1) : 2018	Part 1 for concrete masonry blocks and for applications other than for structural concrete ( <i>first revision</i> )
	(Part 2) : 2018	Part 2 sintered fly ash coarse aggregate ( <i>first revision</i> )
(8)	2185	Specification for concrete masonry units

	(Part 1) : 2005	Hollow and solid concrete blocks ( <i>third revision</i> )
	(Part 2) : 1983	Hollow and solid lightweight concrete blocks ( <i>first revision</i> )
	(Part 3) : 1984	Autoclaved cellular (aerated) concrete blocks ( <i>first revision</i> )
	(Part 4) : 2008	Preformed foam cellular concrete blocks
	12440 : 1988	Specification for precast concrete stone masonry blocks
(9)	2572 : 2005	Code of Practice for construction of hollow concrete block masonry ( <i>first revision</i> )
	6041 : 1985	Code of Practice for construction of autoclaved cellular concrete block masonry ( <i>first revision</i> )
	6042 : 1969	Code of Practice for construction of lightweight concrete block masonry
(10)	1725 : 2023	Stabilized Soil Blocks Used In General Building Construction Specification ( <i>third revision</i> )
(11)	401 : 2001	Code of practice for preservation of timber ( <i>fourth revision</i> )
	1141 : 1993	Code of practice for seasoning of timber ( <i>second revision</i> )
(12)	303 : 1989	Specification for plywood for general purposes ( <i>third revision</i> )
	710 : 2010	Specification for marine plywood ( <i>second revision</i> )
	1328 : 1996	Specification for veneered decorative plywood ( <i>third revision</i> )
	1658 : 2006	Specification for fibre hardboards ( <i>third revision</i> )
	1659 : 2004	Specification for block boards ( <i>fourth revision</i> )
	3087 : 2005	Specification for wood particle boards (medium density) for general purposes ( <i>second revision</i> )
	3097 : 2006	Specification for veneered particle boards ( <i>second revision</i> )
	3129 : 1985	Specification for low density particle board ( <i>first revision</i> )
	3308 : 1981	Specification for wood wool building slabs ( <i>first revision</i> )
	4990 : 2011	Specification for plywood for concrete shuttering work ( <i>third revision</i> )

	5509 : 2021	Fire Retardant Plywood - Specification ( <i>third revision</i> )
	12406 : 2021	Specification for medium density fibre boards for general purpose ( <i>second revision</i> )
	12823 : 2015	Specification for wood products – Prelaminated particle boards ( <i>first revision</i> )
	13958 : 1994	Specification for bamboo mat board for general purposes
	14587 : 2023	Prelaminated Medium Density Fibre Board - Specification
	14588 : 1999	Specification for bamboo mat veneer composite for general purposes
	14616 : 1999	Specification for laminated veneer lumber
	14842 : 2000	Specification for coir veneer board for general purposes
	15380 : 2023	Moulded High Density Fibre HDF Panelled Door Shutters - Specification ( <i>first revision</i> )
	15476 : 2004	Specification for bamboo and corrugated sheets
	15491 : 2004	Specification for medium density coirboards for general purposes
	15877 : 2010	Specification for coir faced block boards
	15878 : 2010	Specification for coir hardboard for general purposes
(13)	2250 : 1981	Code of practice for preparation and use of masonry mortars ( <i>first revision</i> )
	4443 : 1980	Code of practice for use of resin type chemical resistant mortars ( <i>first revision</i> )
	4832	Specification for chemical resistant mortars:
	(Part 1) : 2023	Silicate type
	(Part 2) : 2023	Resin type
	(Part 3) : 2023	Sulphur type
(14)	13077 : 1991	Guide for preparation and use of mud mortar in masonry
(15)	653 : 1992	Specification for linoleum sheets and tiles ( <i>third revision</i> )
	1198 : 1982	Code of practice for laying, fixing and maintenance of linoleum floor ( <i>first revision</i> )

- (16) 1237 : 2012 Specification for cement concrete flooring tiles  
(*second revision*)
- 1443 : 2018 Code of practice for laying and finishing of cement  
concrete tiles (*second revision*)
- 2114 : 2018 Code of practice for laying in-situ terrazzo floor  
finish ( *second revision* )
- (17) 15622 : 2017 Pressed Ceramic Tiles - Specification (*first revision*)
- (18) 1661 : 1972 Code of practice for application of cement and  
cement-lime plaster finish (*first revision*)
- (19) 2547 Specification for gypsum building plaster
- (Part 1) : 1976 Excluding premixed lightweight plaster (*first  
revision*)
- (Part 2) : 1976 Premixed lightweight plaster (*first revision*)
- 12679 : 2023 By-Product Gypsum for Construction Specification  
(*second revision*)
- (20) 14862 : 2000 Specification for fibre cement flat sheets
- 14871 : 2000 Specification for products in fibre reinforced cement  
long corrugated or asymmetrical section sheets and  
fittings for roofing and cladding
- (21) 2095 Specification for gypsum plaster boards
- (Part 1) : 2023 Plain Gypsum Plaster Boards (*fourth revision*)
- (Part 2) : 2022 Coated laminated gypsum plaster boards(*third  
revision*)
- (Part 3) : 2022 Reinforced Gypsum Plaster Boards Tiles Cornices  
and Mouldings (*fourth revision*)
- 8272 : 1984 Specification for gypsum plaster for use in the  
manufacture of fibrous plasterboards (*first revision*)
- (22) 4021 : 1995 Specification for timber door, window and ventilator  
frames
- (23) 6523 : 1983 Specification for precast reinforced concrete door  
and window frames (*first revision*)
- (24) 8183 : 2024 Bonded mineral wool - Specification (*second  
revision*)
- (25) 3677 : 1985 Specification for unbonded rock and slag wool for  
thermal insulation (*second revision*)
- (26) 2115 : 1980 Code of practice for flat roof finish: Mud *phuska*  
(*second revision*)

- (27) 4082 : 1996 Recommendations on stacking and storage of construction materials and components at site (*second revision*)
- 7969 : 1975 Safety code for handling and storage of building materials
- (28) 10500 : 2012 Drinking water (*second revision*)
- 11624 : 2019 Quality of Irrigation Water - Guidelines (*first revision*)
- 8188 : 1999 Treatment of Water for Cooling Towers – Code of Practice
- 201 : 2022 Quality tolerances for water for textile industry (*third revision*)
- 2724 : 2017 Quality tolerances for water for pulp and paper (*first revision*)
- 2725 : 2022 Quality tolerances for water for rayon-manufacturing industry (*first revision*)
- 3328 : 1993 Quality tolerances for water for swimming pools (*first revision*)
- 4221 : 2022 Quality Tolerances for Water for Tanning Industry (*first revision*)
- 4251 : 1967 Quality tolerances for water for processed food industry
- 4700 : 1968 Quality tolerances for water for fermentation
- 8914 : 2022 Quality tolerances for water for vitreous enamel industry (*second revision*)
- 10392 : 1982 Specification for feed water and boiler water for low and medium pressure boilers
- 10496 : 1983 Specification for feed water, boiler water and condensate for high pressure boilers
- 13891 : 1994 Quality tolerances for fresh water for fish culture
- (29) 15883 Guidelines for construction project management: General  
(Part 1) : 2009
- (30) 456 : 2000 Code of practice for plain and reinforced concrete (*fourth revision*)
- 1343 : 2012 Code of practice for prestressed concrete (*second revision*)
- (31) 4130 : 1991 Safety code for demolition of buildings

- (32) 6598 : 2018 Specification for cellular concrete for thermal Insulation (*first revision*)
- (33) IS 16656:2017 Refrigerants - Designation and safety classification
- (34) 12615 : 2018 Line Operated Three Phase a.c. Motors (IE CODE) "Efficiency Classes and Performance Specification" (*third revision*)
- (35) IS/ISO 14040 : 2006 Environmental management — Life cycle assessment — Principles and framework (*first revision*)
- (36) IS/ISO 14044 : 2006 Environmental management — Life cycle assessment — Requirements and guidelines

\*\*\*\*\*