

भारतीय मानक ब्यूरो

DRAFT FOR WIDE CIRCULATION

(Not to be reproduced without permission of BIS or used as an Indian Standard)

भारतीय मानक प्रारूप

टांका तार - ठोस और फ्लक्स कोरड - विशिष्टता

(आई एस 1921 का तीसरा पुनरीक्षण)

Draft Indian Standard

Solder Wire — Solid and Flux Cored — Specification

(Third Revision of IS 1921)

ICS No. 25.160.50

Ores and Feed Stock for Non-Ferrous (Excluding Aluminium and Copper) Industry, their Metals/ Alloys and Products Sectional Committee, MTD09

Last date for receipt of comments is
09 October 2024

FOREWORD

(Formal clauses of the foreword to be added later.)

This Indian Standard (Third Revision) was first published in 1961 and was subsequently revised in 1975 and 2005. In the first revision, the title of the standard was changed from 'Specification for rosin-cored solder wire activated and non-activated (non-corrosive)' to 'Specification for rosin-cored solder wire'. Besides the title change, the requirements for activity and mobility laid down in the standard were deleted as difficulties were being experienced with regard to the test method for determining the activity and mobility, which relied on qualitative assessment and observer judgment. In addition to these changes, the first revision of the standard also modified the tolerance on the size of wire and introduced a new clause on sampling for tests. In the second revision, title of the standard was modified to 'Flux cored solder wire — Specification' and the impurity limits of Al, Zn or Cd were restricted to 0.08 percent as their presence is harmful. While reviewing the standard in light of the experience gained since the second revision and considering the latest developments in flux-cored solder wires especially with regard to the new test methods developed for assessing the properties of flux, this third revision has been brought out, to include non-fluxed solid wires, more varieties/grades of solder alloys and additional flux compositions/types apart from the rosin fluxes. It also classifies the fluxes according to the internationally accepted standards and recognized test methods. In addition to these changes, the following major modifications have been made in this current revision:

- a) Title of the standard has been modified from 'Flux cored solder wire — Specification' to 'Solder wire — Solid and flux cored— Specification' ;
- b) The scope has been expanded to include requirements for both solid and flux-cored solder wires, classification of fluxes in cored wire based on their constituents, performance requirements, and test methods in line with international practices. The earlier version of the standard covered only Rosin-based fluxes, whereas this revision includes fluxes based on four compositions: Rosin (RO) (colophony or modified colophony), Resin (RE), Organic (OR), and Inorganic (IN), aligning with internationally accepted standards;
- c) Clause on terminology has been incorporated;
- d) The clause on chemical composition has been updated to include both lead-containing and lead-free grades as specified in IS 193/ISO 9453, compared to the previous version, which listed only five grades based on Pb-Sb alloys. The standard now covers approximately 30 lead-containing alloys grouped into 10 categories based on their main alloying elements and 31 grades of lead-free solder grouped into 21 categories. Additionally, the current revision allows for the use of other alloys, provided they meet the impurity limits specified in section 6.2.2.
- e) The earlier version of the standard restricted the flux percentages from 2 percent to 4 percent, which now has been relaxed and kept as agreed between purchaser and the supplier. However, the now standard specifies tolerance limits on the declared flux percentages.
- f) Clause on dimensions and tolerances has been modified to include additional recommended sizes given in in Table 3. The standard no longer restricts other wire dimensions but imposes limits on tolerance levels.
- g) Clause on sampling has been modified;
- h) Clause on testing frequencies have been included in the standard, according to which the manufacturer shall perform tests on the solid and flux cored solder wires at the frequencies given to insure that the process is in control and the final product conform to this standard;
- j) Annex A has been incorporated in the standard, which specifies two methods for the extraction of flux incorporated in flux cored solder wire. The solution so obtained may be used for testing purposes of fluxes.
- k) Annex D on flux classification and characterization has been included in the standard which gives the detailed classification of the fluxes used in the manufacture of solder wire and, the classification parameters and requirements for classifying the fluxes;
- m) Annex E has been included in the standard which specifies the procedure for determination of flux content in the flux cored solder wire;
- n) Various annexures have been added for test methods such as Annex F for spread test of cored wire ,Annex G for flux residue dryness test , Annex H for measurement of nominal diameter , Annex J for copper mirror test, Annex for copper plate corrosion test, Annex L for determination of non-volatile content of extracted flux, Annex M for quantitative determination of halide content, Annex N for qualitative determination of halide content, Annex P and Annex Q for surface insulation resistance test and electrochemical migration resistance test out of which Annex Q is the referee method and Annex T has been included for acid value determination; and
- p) The standard has also prescribed certain optional tests, which include spread test, Electrochemical Migration Resistance (ECM) test and halogen content test.

Lead is known to be one of the toxic material directly responsible for many present day diseases and body poisoning. The levels of toxicants like lead are very high in the vicinity where of solder/solder wire are being manufactured. Therefore, utmost care is required to be taken to minimize the lead in work place air, ambient air and in the industrial effluents. To provide for personnel safety, it is recommended to follow

the applicable union/local occupational, safety and health regulations such as '*The occupational safety, health and working conditions code, 2020*'.

Since the solders (both cored and solid) contain hazardous materials like lead, cadmium etc and is also the part of e-Waste, it is recommended to follow the *E-Waste (management) Rules, 2022 as amended from time to time*.

For the information of the users of this standard, the grades which were covered in the second revision of IS 1921 are given in Annex U.

An example for inspection report for flux classification/characterization, and the final product (solid/flux cored solder wire) are given in Annex C and Annex V respectively, for guidance purposes only.

The committee responsible for the formulation of this standard is given in Annex V.

For the purpose of deciding whether a particular requirement of this standard is complied with, the final value, observed or calculated, expressing the result of a test or analysis, shall be rounded off in accordance with IS 2 : 2022 '*Rules for rounding off numerical values (second revision)*'. The number of significant places retained in the rounded off value should be the same as that of the specified value in this standard.

CONTENTS

	<i>Page No.</i>
1 SCOPE	... 1
2 REFERNCES	... 1
3 TERMS AND DEFINITIONS	... 2
4 SUPPLY OF MATERIALS	... 6
5 RAW MATERIALS FOR MANUFACTURE OF SOLDER ALLOYS	... 6
6 SOLDER ALLOY	... 6
6.1 Solder Alloy Designation	... 6
6.2 Chemical Composition of Solder Alloy	... 6
7 FLUX	... 7
7.1 General Characteristics of Flux of Flux Cored Solder Wire	... 7
7.2 Flux Classification and Characterization	... 8
7.3 Flux Percentage or Flux Content	... 8
7.4 Acid Value	... 8
7.5 Flux Residue Dryness/Tackiness Test	... 9
7.6 Spread Test (Optional)	... 9
7.7 Halogen Content Test (Optional)	... 9
8 DIMENSIONS AND TOLERANCES	... 10
9 SAMPLING FOR TESTS	... 10
9.1 Sampling for Chemical Analysis of the Solder Alloy	... 11
9.2 Sampling for Tests to Determine the Properties of the Flux Core	... 12
9.3 Sampling for Tests to Determine the Flux Content and the Diameter of the Solid and Flux Cored Solder Wire	... 13
10 RETEST AND REJECTION	... 13
11 TESTING FREQUENCIES	... 13
12 PACKAGING	... 14
13 MARKING	... 14
ANNEX A FLUX EXTRACTION PROCEDURE AND DETERMINATION OF MASS FOR FLUX CORED SOLDER WIRE	... 15
A-1 GENERAL	... 15
A-2 METHODS OF FLUX EXTRACTION FROM CORED WIRE	... 15
A-2.1 Method A	... 15

A-2.2 Method B	...	16
ANNEX B GUIDANCE ON FORM OF THE TEST SPECIMEN OF FLUX TO BE USED FOR CALSSIFICATION TESTING	...	18
ANNEX C GUIDANCE ON THE TEST REPORT OF FLUX OF FLUX CORED SOLDER WIRE	...	21
ANNEX D FLUX CLASSIFICATION AND CHARECTERIZATION	...	24
D-1 FLUX DESIGNATION AND IDENTIFICATION SYSTEM	...	24
D-2 CLASSIFICATION	...	25
D-2.1 Flux Composition	...	25
D-2.2 Flux Type	...	25
D-2.2.1 <i>Flux Activity</i>	...	25
D-2.2.2 <i>Halide Content</i>	...	26
D-2.2.3 <i>Additional information on Flux Activity</i>	...	27
D-4 QUALIFICATION TESTING	...	27
D-4.1 Classification/Characterization Testing	...	27
D-4.1.1 <i>Copper Mirror Test</i>	...	27
D-4.1.2 <i>Copper Plate Corrosion Test</i>	...	28
D-4.1.3 <i>Halide Content Tests</i>	...	28
D-4.1.3.1 <i>Qualitative halide content test</i>	...	28
D-4.1.3.2 <i>Quantitative halide content test</i>	...	29
D-4.1.4 <i>Surface Insulation Resistance Test</i>	...	29
D-4.1.4.1 <i>Reporting SIR test results</i>	...	30
D-4.1.4.2 <i>SIR test criteria</i>	...	30
D-4.1.5 <i>Resistance to ECM Test (Optional)</i>	...	30
D-4.1.5.1 <i>Reporting ECM test results</i>	...	30
ANNEX E DETERMINATION OF FLUX CONTENT	...	32
E-1 SCOPE	...	32
E-2 PRINCIPLE	...	32
E-3 TEST SPECIMEN	...	32
E-4 APPARATUS AND MATERIALS	...	32
E-5 PROCEDURE	...	32
E-5.1 Method A	...	32
E-5.2 Method B	...	32
E-6 EXPRESSION OF RESULTS FOR BOTH METHODS	...	34

ANNEX F	SPREAD TEST OF EXTRACTED CORE WIRE	...	35
	F-1 OBJECTIVE OF THE TEST METHOD	...	35
	F-2 PRINCIPLE	...	35
	F-3 TEST SAMPLE	...	35
	F-4 REAGENTS AND MATERIALS	...	35
	F-5 APPARATUSES AND INSTRUMENTS	...	35
	F-6 TEST PROCEDURE	...	36
	F-6.1 Preconditioning of Copper Plate	...	36
	F-6.2 Test Operation	...	36
	F-7 EVALUATION	...	37
	F-7.1 Calculation of Spreadability	...	37
	F-7.2 Calculation of Spread Area	...	37
ANNEX G	FLUX RESIDUES TEST — EVALUATION OF TACKINESS OF FLUX RESIDUE	...	38
	G-1 OBJECTIVE OF THE TEST METHOD	...	38
	G-2 PRINCIPLE	...	38
	G-3 TEST SPECIMEN	...	38
	G-4 REAGENT AND MATERIALS	...	38
	G-5 APPARATUS AND INSTRUMENTS	...	38
	G-6 TEST PROCEDURE, EXAMINATION AND EVALUATION	...	39
	G-6.1 Preparation of Copper Test Piece	...	39
	G-6.2 Heating the Test Piece	...	40
	G-6.3 Examination of the Test Piece	...	40
	G-6.4 Evaluation	...	40
ANNEX H	MEASUREMENT OF NOMINAL DIAMETER	...	41
ANNEX J	FLUX INDUCED CORROSION (COPPER MIRROR METHOD)	...	42
	J-1 OBJECTIVE OF THE TEST METHOD	...	42
	J-2 PRINCIPLE	...	42
	J-3 REAGENTS AND MATERIALS	...	42
	J-4 APPARATUS AND INSTRUMENTS	...	42
	J-5 TEST SPECIMEN	...	42
	J-6 TEST PROCEDURE	...	43
	J-6.1 Preparation	...	43
	J-6.1.1 <i>Preparation of Standard Rosin Solution/Rosin Reference Solution – 25 Percent (m/m)</i>	...	43

J-6.1.2 <i>Preparation of Temperature/Humidity Chamber</i>	... 43
J-6.1.3 <i>Preparation of Copper Mirror Test Panels</i>	... 43
J-6.2 Test	... 43
J-6.3 Evaluation	... 44
J-6.4 Test Report	... 44
ANNEX K COPPER PLATE CORROSION TEST	... 45
K-1 OBJECTIVE AND PRINCIPLE OF THE TEST METHOD	... 45
K-2 TEST SPECIMEN	... 45
K-3 REAGENTS AND MATERIALS	... 45
K-4 APPARATUS	... 45
K-5 PREPARATION OF TEST PIECES	... 46
K-6 PROCEDURE	... 47
K-6.1 General	... 47
K-6.2 Fluxing the Test Pieces	... 47
K-6.2.1 <i>For Flux-Cored Solder Samples</i>	... 47
K-6.2.2 <i>For Solid, Paste and Liquid Flux Samples</i>	... 47
K-6.2.3 <i>For Solder Paste Samples</i>	... 48
K-6.3 Heating the Test Pieces	... 48
K-6.4 Conditioning the Test Pieces	... 48
K-6.5 Examination of the Test Pieces	... 49
K-6.6 Assessment/Evaluation of Corrosion	... 49
K-6.6.1 <i>General</i>	... 49
K-6.6.2 <i>Examination After Fluxing and Melting</i>	... 50
K-6.6.3 <i>Examination After Conditioning</i>	... 50
K-7 EXPRESSION OF RESULTS	... 50
K-8 TEST REPORT	... 50
K-9 ADDITIONAL INFORMATION (PHOTOGRAPHIC IMAGES) ON VARIOUS DEGREES OF CORROSION ARISING FROM COPPER CORROSION TEST	... 51
ANNEX L FLUX SOLIDS /NON-VOLATILE MATTER CONTENT TEST	... 57
L-1 OBJECTIVE OF THE TEST METHOD	... 57
L-2 PRINCIPLE	... 57
L-3 TEST SPECIMEN	... 57
L-4 APPARATUSES AND REAGENTS	... 57
L-5 PROCEDURES	... 57

L-5.1 Preparation	... 57
L-5.2 Test	... 57
L-6 EVALUATION	... 58
L-7 REPORTING	... 58
L-8 ADDITIONAL INFORMATION	... 58
ANNEX M HALIDE CONTENT TEST	... 59
M-1 QUANTITATIVE DETERMINATION OF HALIDE CONTENT IN FLUXES (CHLORIDE AND BROMIDE)	... 59
M-1.1 Objective of the Test Method	... 59
M-1.2 Visual Titration (Method A)	... 59
M-1.2.1 <i>Test Specimen</i>	... 59
M-1.2.2 <i>Apparatus and Reagent</i>	... 59
M-1.2.3 <i>Procedure</i>	... 60
M-1.2.3.1 <i>Rosin/resin fluxes specimen preparation</i>	... 60
M-1.2.3.2 <i>For organic and inorganic (water soluble) fluxes</i>	... 60
M-1.2.4 <i>Test</i>	... 60
M-1.2.5 <i>Calculations</i>	... 60
M-1.3 Potentiometric Titration Method (Method B)	... 61
M-1.3.1 <i>Principle</i>	... 61
M-1.3.2 <i>Reagents</i>	... 61
M-1.3.3 <i>Apparatuses and Instruments</i>	... 62
M-1.3.4 <i>Test Procedure</i>	... 62
M-1.3.4.1 <i>Resin/Rosin flux cored solder (flux not available)</i>	... 62
M-1.3.4.2 <i>Resin/Rosin flux cored solder (flux available), solder paste, liquid flux and solid flux</i>	... 63
M-1.3.5 <i>Calculation of Halide Content</i>	... 63
M-2 QUANTITATIVE DETERMINATION OF FLUORIDE CONTENT IN FLUXES	... 64
M-2.1 Objective of the Test Method	... 64
M-2.2 Test Specimen	... 64
M-2.3 Apparatus and Reagents	... 64
M-2.3.1 <i>Apparatus</i>	... 64
M-2.3.2 <i>Reagents</i>	... 64
M-2.3.3 <i>Procedure</i>	... 65
M-2.3.3.1 <i>Specimen preparation of water-soluble flux</i>	... 65

M-2.3.3.2 <i>Specimen preparation of non-water soluble flux</i>	...	65
M-2.3.3.3 <i>Standard solutions</i>	...	66
M-2.3.3.4 <i>Double reference electrode filling solutions</i>	...	66
M-2.3.4 <i>Test</i>	...	66
M-2.3.5 <i>Calculation</i>	...	66
M-2.3.6 <i>Calibration and Limits</i>	...	67
ANNEX N QUALITATIVE HALIDE CONTENT TEST	...	67
N-1 DETERMINATION OF HALIDES IN FLUXES, SILVER CHROMATE	...	67
METHOD		
N-1.1 Objective of the Test Method	...	68
N-1.2 Test Specimen	...	68
N-1.3 Apparatus and Reagents	...	68
N-1.4 Procedure	...	68
N-1.4.1 <i>Preparation</i>	...	68
N-1.4.2 <i>Test for Liquid Flux or Flux Extract Solution</i>	...	68
N-1.4.3 <i>Evaluation</i>	...	68
N-1.4.4 <i>Interferences</i>	...	68
N-2 QUALITATIVE ANALYSIS OF FLUORIDES AND FLUXES BY SPOT	...	69
TEST		
N-2.1 Objective of the Test Method	...	69
N-2.2 Test Specimen	...	69
N-2.3 Apparatus and Reagents	...	69
N-2.3.1 <i>Apparatus</i>	...	69
N-2.3.2 <i>Reagents</i>	...	70
N-2.4 Procedure	...	70
N-2.4.1 <i>Preparation</i>	...	70
N-2.4.2 <i>Test</i>	...	70
N-2.4.3 <i>Evaluation</i>	...	70
ANNEX P SURFACE INSULATION RESISTANCE AND	...	71
ELECTOCHEMICAL MIGRATION RESISTANCE TEST		
P-1 SCOPE	...	71
P-2 OUTLINE OF THE TEST	...	71
P-3 PRINCIPLE	...	71
P-4 REAGENTS AND MATERIALS	...	72
P-5 APPARATUSES AND INSTRUMENTS	...	73

P-6 TEST CONDITIONS	...	74
P-7 TEST PROCEDURE	...	74
P-7.1 Pre-Cleaning of Test Boards	...	74
P-7.2 Confirmation of Insulation Resistance Value of Test Board	...	74
P-7.3 Conditioning of Test Specimens	...	75
P-7.3.1 <i>For Liquid Flux and Paste Flux</i>	...	75
P-7.3.2 <i>For Solid Flux</i>	...	75
P-7.3.3 <i>Flux Cored Solder Wire or Preform Samples</i>	...	75
P-7.3.3.1 <i>Using flux extract or solid flux samples</i>	...	75
P-7.3.3.2 <i>Using flux cored wire itself</i>	...	76
P-7.4 Conditioning of Test Specimens Requiring Washing	...	76
P-7.5 Wiring to Electrodes	...	76
P-7.6 Operation	...	77
P-7.7 Application of Bias Voltage	...	78
P-8 RESISTANCE MEASUREMENTS	...	79
P-9 DATA ANALYSIS	...	80
P-10 EVALUATION	...	81
P-11 ELECTROCHEMICAL MIGRATION (ECM) TEST	...	81
P-12 GENERAL SIR TESTING GUIDANCE	...	82
P-12.1 Test Conditions	...	82
P-12.2 Risk of Condensation	...	82
P-12.3 Example of Geometric Mean Calculation	...	83
ANNEX Q SURFACE INSULATION RESISTANCE COMB TEST AND ELECTROCHEMICAL MIGRATION TEST OF FLUX RESIDUES	...	85
Q-1 SCOPE	...	85
Q-2 PRINCIPLE	...	86
Q-3 REAGENTS	...	86
Q-4 APPARATUS	...	86
Q-5 INSPECTION OF TEST COUPONS	...	94
Q-5.1 Surface Plating	...	94
Q-5.2 Surface Laminate	...	94
Q-6 SAMPLE PREPARATION	...	95
Q-6.1 Preparation of the Flux Test Solution	...	95

Q-6.1.1 <i>Solid Flux Samples</i>	... 95
Q-6.1.2 <i>Flux-Cored Solder Wire or Preform Samples</i>	... 95
Q-6.2 Preparation of the Test Coupons	... 95
Q-6.2.1 <i>Sample Identification</i>	... 95
Q-6.2.2 <i>Test Coupons</i>	... 95
Q-6.2.3 <i>Test Coupon Pre-Cleaning</i>	... 96
Q-7 PROCEDURE	... 97
Q-7.1 Methods for Connecting Test Coupons to the Measurement System	... 97
Q-7.1.1 <i>Board Circuitry Layout</i>	... 97
Q-7.1.2 <i>Preconditioning Of SIR Test Coupons Prior to Processing</i> (<i>Optional</i>)	... 99
Q-7.2 Fluxing and Soldering Test Patterns	... 99
Q-7.2.1 <i>Liquid Flux or Flux Extract of Cored Wire</i>	... 99
Q-7.2.2 <i>Cored Wire</i>	... 100
Q-7.3 Cleaning of Samples	... 100
Q-7.4 Surface Insulation Resistance (SIR) Test	... 101
Q-7.4.1 <i>High-Resistance Measurement System Verification</i>	... 101
Q-7.4.2 <i>Test Coupon Measurement Procedure</i>	... 101
Q-7.4.3 <i>Measurements</i>	... 102
Q-7.5 Electrochemical Migration (ECM) Test	... 103
Q-8 ASSESSMENT/EVALUATION FOR DENDRITE AND OTHER VISIBLE CHANGES	... 103
Q-9 PRECISION	... 104
Q-10 TEST REPORT	... 104
ANNEX R GENERAL SIR TESTING GUIDANCE	... 105
R-1 TEST COUPONS	... 105
R-2 TEST COUPON DEVELOPMENT	... 105
R-3 COUPON COUNT	... 105
R-4 DERIVED UNIT OF SIR	... 105
R-5 TEST CONDITIONS	... 105
R-5.1 General	... 105
R-5.2 90 PERCENT RH OR 93 PERCENT RH	... 106
R-5.3 VOLTAGE	... 106
R-6 RISK OF CONDENSATION	... 106
R-7 PRECAUTIONS	... 106

R-8 FREQUENCY OF MONITORING	...	107
R-9 ELECTROMAGNETIC SHIELDING	...	107
R-10 CONNECTIONS	...	107
R-11 ADVANTAGES AND DISADVANTAGES OF USING CONNECTORS AS PART OF THE MEASUREMENT SYSTEM	...	107
R-11.1 Advantages	...	107
R-11.2 Disadvantages	...	107
ANNEX S SURFACE INSULATION RESISTANCE COMB TEST AND ELECTROCHEMICAL MIGRATION TEST OF FLUX RESIDUES — QUALIFICATION TEST REPORT	...	108
ANNEX T DETERMINATION OF ACID VALUE BY POTENTIOMETRIC AND VISUAL TITRATION METHODS	...	111
T-1 OBJECTIVE OF THE TEST METHOD	...	111
T-2 TEST SPECIMEN	...	111
T-3 METHOD A — POTENTIOMETRIC TITRATION METHOD	...	111
T-3.1 Principle	...	111
T-3.2 Reagents	...	111
T-3.3 Apparatus	...	112
T-3.4 Procedure	...	112
T-3.4.1 <i>General</i>	...	112
T-3.4.2 <i>Manual Procedure</i>	...	112
T-3.4.3 <i>Automated Procedure</i>	...	113
T-3.5 Calculation of Results	...	113
T-4 METHOD B — TITRATION METHOD WITH VISUAL END POINT	...	114
T-4.1 Principle	...	114
T-4.2 Reagents	...	114
T-4.3 Apparatus	...	114
T-4.4 Procedure	...	114
T-4.5 Calculation of Results	...	115
ANNEX U GRADES COVERED IN THE SECOND REVISION OF THIS INDIAN STANDARD	...	116
ANNEX V GUIDANCE TEST REPORT FOR SOLID AND FLUX CORED SOLDER WIRE	...	117
ANNEX W COMMITTEE COMPOSITION	...	118
BIBLIOGRAPHY	...	121

*Draft Indian Standard***SOLDER WIRE — SOLID AND FLUX CORED — SPECIFICATION***(Third Revision)***1 SCOPE**

This standard covers requirements of solid and flux cored solder wire, classification of fluxes in cored wire as per its constituents, its performance requirements and test methods.

NOTES

1 Annex A specifies two methods for the extraction of flux incorporated in flux cored solder wire. The solution so obtained may be used for testing purposes. Alternatively, the flux obtained directly from the supplier can also be used for testing the flux provided that no additives have been added to the flux except for inert plasticizers.

2 Annex B gives the form of the test specimen of flux to be used for classification test and the main purpose of the test.

3 Annex C gives the guidance on the test report of the fluxes of flux cored solder wire.

2 REFERENCES

The following standards contain provisions which through reference in this text, constitute provisions of this standard. At the time of publication, the editions indicated were valid. All standards are subject to revision, and parties to agreements based on this standard are encouraged to investigate the possibility of applying the most recent editions of these standards:

<i>IS No.</i>	<i>Title</i>
IS 26 : 2024	Tin ingot — Specification (<i>fifth revision</i>)
IS 27 : 2023	Primary lead — Specification (<i>fifth revision</i>)
IS 191 : 2007	Copper — Specification (<i>fourth revision</i>)
IS 193 : 2024 / ISO 9453:2020	Soft solder alloys — Chemical compositions and forms — Specification (<i>sixth revision</i>)
IS 209 : 2024	Refined zinc — Specification (<i>fifth revision</i>)
IS 211 : 2024	Antimony ingot — Specification (<i>fifth revision</i>)
IS 553 : 1984	Specification for rosin (gum rosin) (<i>second revision</i>)
IS 959 : 1994	Specification for electric soldering irons (<i>third revision</i>)
IS 998	Methods of chemical analysis of solders (Soft and Rosin-Cored)
(Part1) : 1983	Determination of tin and antimony (<i>first revision</i>)
(Part 2) : 1983	Determination of iron, copper and arsenic (<i>first revision</i>)
(Part3) : 1983	Determination of cadmium, zinc, aluminium, bismuth and nickel (<i>first revision</i>)
IS 1387 : 1993	General requirements for the supply of metallurgical materials (<i>second revision</i>)
IS 2214 : 1977	Specification for silver nitrate, pure and analytical reagent (<i>first revision</i>)
IS 2279 : 1980	Specification for fine silver bar, sheet, wire, granules and token (<i>first revision</i>)
IS 5479 : 2024	Solders for jointing aluminium and aluminium alloys — Specification (<i>second revision</i>)
IS 6344 : 2006	Cadmium metal — Specification (<i>second revision</i>)
IS 9000 (Part 4) : 2020 / IEC 60068-2-78:2012	Environmental testing : Part 4 Tests — Test cab damp heat, steady state (<i>second revision</i>)

IS 10175 : 2018 / ISO 20482:2013	Metallic materials — Sheet and strip — Erichsen cupping test (<i>third revision</i>)
IS 12305 : 2018 / ISO 4793 : 1980	Laboratory sintered (fritted) filters — Porosity grading, classification and designation (<i>first revision</i>)
IS 14811 : 2000	Rolled copper plate, sheet, strip and foils for general engineering purposes — Specification
IS 15287 (Part 3) : 2018/ ISO 6344-3 : 2013	Coated abrasives — Grain size analysis: Part 3 Determination of grain size distribution of microgrits P240 to P2500 (<i>first revision</i>)
IS 15393 (Part 2) : 2021 / ISO 5725-2 : 2019	Accuracy trueness and precision of measurement methods and results :Part 2 Basic method for the determination of repeatability and reproducibility of a standard measurement method
IS 17278 : 2019	Refined gold and silver bars for good delivery — Specification
IEC TR 61189-5-506:2019	Test methods for electrical materials, printed boards and other interconnection structures and assemblies : Part 5-506 General test methods for materials and assemblies — An intercomparison evaluation to implement the use of fine-pitch test structures for surface insulation resistance (SIR) testing of solder fluxes in accordance with IEC 61189-5-501

3 TERMS AND DEFINITIONS

3.1 Soft Solder or Solder — Metallic filler material which is used to join metallic parts and which has a melting temperature (liquidus) lower than that of the parts to be joined and usually, lower than 450 °C and which wets the parent metals. This standard also allows some special alloys which have melting points up to 485 °C which would not be considered solder in normal circumstances, (for example solders for jointing aluminum and aluminum alloys given in IS 5479).

3.2 Base Metal (Solder) — The underlying metal surface to be wetted by solder, also referred to as parent metal.

3.3 Flux — A chemically and physically active compound that, when heated, promotes the wetting of a base metal surface by molten solder by removing minor surface oxidation and other surface films and by protecting the surfaces from reoxidation during a soldering operation.

NOTE — Flux can be in solid, liquid or paste form. However, for the purpose of flux cored solder wires, the flux is in the solid form.

3.4 Liquid Flux — Solution of a flux in a suitable liquid solvent.

3.5 Paste Flux — Solution or uniform dispersion of flux powder in a suitable viscous medium.

3.6 Unit of Product (*see IS 193, Clause 5.2 also*) — The unit of product used for defining the requirements for the marking of soft solders varies with the form of the solder and is given in the Table below.

<i>Sl No.</i>	<i>Form of Solder</i>	<i>Unit of Product</i>
---------------	-----------------------	------------------------

(1)	(2)	(3)
i)	Ingot, bar, slab, stick or rod	A single ingot, bar, slab, stick or rod
ii)	Wire or ribbon (cored or non-cored/coated or non-coated)	A single coil or reel
iii)	Preforms and rings, spheres, pellets or powder	The individual packaged quantity
iv)	Powder in solder pastes	The individual packaged quantity

3.7 Batch/Lot — Collection of one or more units of product, made in a single production operation or made from a single uniform melt.

3.8 Consignment — Quantity of product, consisting of one or more batches of the same grade delivered at the same time, by the supplier to the purchaser.

3.9 Batch Sample — One or more units of product selected at random from the batch and considered, in total, to be representative of the batch.

3.10 Test Sample Stick — Stick of solder prepared by melting the whole of, or a representative fraction of the batch sample and pouring it into a suitably shaped cast iron or aluminum mould or stainless steel mould or any other mould as agreed between the purchaser and supplier.

3.11 Analysis Sample — Representative sample prepared from the test sample stick and used for the determination of the chemical composition.

3.12 Flux Characterization — Flux characterization consists of a series of specific tests for fluxes and flux residues in order to determine their impact on product reliability. These tests include determination of basic corrosive and conductive properties of flux and flux residues.

3.13 Flux Residue — The (non-volatile) portion of the flux material that remains on and around the solder joint after soldering.

3.14 Wetting — The formation of a relatively uniform, smooth, unbroken, and adherent film of solder to a base metal.

3.15 Non-Wetting — A condition whereby a surface has contacted molten solder, but the solder has not adhered to the entire surface; base metal remains exposed.

3.16 Dewetting — A condition that results when molten solder coats a surface and then recedes to leave irregularly shaped mounds of solder that are separated by areas that are covered with a thin film of solder and with the basis metal not exposed.

3.17 Lead Free Solder/Lead Safe Solder — Solder alloy whose lead content is equal to or less than 0.10 percent by mass.

3.18 Corrosion — The deterioration of a metal due to moisture, chemical or electrochemical reaction with its environment; chemical reaction between the copper, the solder, and the flux residues that occurs after soldering and during exposure to the test conditions.

3.19 Solderability — Ability of a metal to be wetted by molten solder.

3.20 Eutectic (Solder) — Solder alloy that melts and solidifies at a single temperature that is the lowest temperature of solidification for any mixture of specified constituents; alloy composition whereby a solder alloy melts/freezes completely without going through a pasty (partially solid) phase; alloy having the composition indicated by the eutectic point on an equilibrium diagram or an alloy structure of intermixed solid constituents formed by an eutectic reaction.

3.21 Solidus (Solder) — The temperature at which a solder alloy begins to melt.

3.22 Liquidus (Solder) — The temperature at which a solder alloy is completely melted.

3.23 Rosin /Colophony (Modified and Natural) — Primarily composed of hard, natural resin, extracted from the oleoresin of pine trees and refined, consisting of abietic and pimaric acids and their isomers, some organic fatty acids and terpene hydrocarbons. These natural rosins or modified rosins used in fluxes shall have an acid value greater than 130 mg KOH/g when determined in accordance with Annex T. A synonym for rosin is colophony.

3.24 Rosin Flux — Flux of which the basis is rosin/colophony; rosin in an organic solvent or rosin as a paste with activators.

NOTE — Modified rosin is included. An organic medium is used as the solvent.

3.25 Resin Flux — Primarily composed of synthetic resins and/or natural resins other than rosin types; resin and small amounts of organic activators in an organic solvent.

3.26 Organic Flux — Primarily composed of organic materials other than rosin or resin; flux of which the basis is organic acid and organic activator.

NOTE — A water-based or an organic medium-based substance is used as the solvent.

3.27 Inorganic Flux — Flux of which the basis is inorganic acid, inorganic salt and inorganic alkali.

NOTE — A water-soluble substance such as glycerine, polyethylene glycol and polyoxyethylene glycol, or a non-water-soluble substance such as wax and vaseline shall be used as the solvent. Flux of this type gains strong active power by the basis; however, the corrosiveness of the residue becomes large.

3.28 Halide Content — Halogen ions are known as halides. Ionic halide content is not to be confused with halogen content. Specifically, chlorine ion is known as chloride or (Cl-), bromine ion is known as bromide or (Br-), fluorine ion is known as fluoride or (F-), iodine ion is known as iodide or (I-) and halide compounds that have ionic character are termed halide compounds. Ionically bonded halogens (halides) do disassociate into negatively charged halide ions (Cl-, Br-,F-, etc.) and positively charged species (H+,

Na+etc.) when dissolved in water. For the purpose of this standard, the determination of halide is mandatory while the halogen content is optional and shall be only done when requested by the user. The halide content is reported as the equivalent weight percentage of chloride to the solid (non-volatile) portion of the flux.

NOTE — Testing for halide content does not include evaluation for halogen content. A material with a '0' indicator may contain non-ionic halogen. The quantitative halide method determines the amount of halide present not halogen. For determining the overall halogen *see* 3.29 and 7.7, which is optional and this current standard talks only about the halide content.

3.29 Halogen Content — Halogen is the term for all chlorine (Cl) and/or bromine (Br) in compounds. These two types of compounds are referenced based upon the EN 14582 test method. Ionic halide content is not to be confused with halogen content. The halogen content determination includes halide content also but not vice versa. Halogen content should be determined using EN 14582 or as agreed between user and supplier followed by Ion chromatography or titration method. In this method, an oxygen bomb is utilized to dissociate the covalently bound halide and this product is dissolved and analyzed via ion chromatography.

3.30 Low Halogen Flux (Cl and Br) — Low halogen materials contain $\leq 1\ 000$ ppm (0.1 percent) Br, and $\leq 1\ 000$ ppm (0.1 percent) Cl. Sample preparation should be as agreed between user and supplier. This definition applies when determining the total halogen content.

3.31 Activator (Flux) — The activator is the main component responsible for metal-oxide removal, and the prevention of its formation during the soldering process. It substance which increases the chemical reactivity of a flux. Activators are what define the 'reactive' characteristics of the flux. This includes how corrosive it is and how effective it is at removing oxide. Common activators include: Amine hydrochlorides; dicarboxylic acids, for example, adipic or succinct acids; organic acids like citric acid, malic acid or abietic acid (from pine tree rosin); halides (not to be confused with halogen) etc.

3.32 Carrier/Vehicle (Flux) — The vehicle is a non-volatile liquid or a solid used to coat the surface during soldering and dissolve metal salts (created during the reduction and oxidation reaction between metal oxides and activators). Example of vehicles are rosin, synthetic resins, glycols and polyglycols, polyethers, glycerine etc. Rosin and resins are the most stable vehicles and have the least impact on reliability, while the others are used primarily in water-soluble fluxes.

3.33 Solvent (Flux) — A solvent is needed to dissolve activators, the vehicle, and other additives, while evaporating during the preheating process.

3.34 SIR — The acronym SIR stands for surface insulation resistance. SIR is defined as the electrical resistance of an insulating material between a pair of contacts, conductors or grounding devices and that is determined under specified environmental and electrical conditions.

3.35 ECM —The acronym ECM stands for electrochemical migration. ECM is defined as the growth of conductive metal filaments under the influence of a DC voltage bias where growth is by electro-deposition from a solution containing metal ions that are dissolved from the anode, transported by the electric field and redeposited at the cathode and specifically excludes phenomena such as field induced metal transport in semiconductors and diffusion of the products arising from metallic corrosion.

4 SUPPLY OF MATERIAL

4.1 General requirements relating to the supply of solder wire shall be as laid down in IS 1387.

4.2 Information to be Given by the Purchaser

4.2.1 Basis for Order/Enquiry

While placing an order/enquiry for the purchase of material covered by this specification, the purchaser/user should specify the following information in order to facilitate the enquiry or order and confirmation of order procedures between purchaser/user and supplier:

- a) IS number of this document;
- b) Alloy designation and composition;
- c) Nominal wire diameter and tolerance;
- d) Flux designator;
- e) Flux percentage;
- f) Flux core requirements, if different (*see 7.1.1.1*);
- g) Flux residue dryness test, if required (*see 7.5*);
- h) Spread test and requirements, if required (*see 7.4*);
- j) Halogen content test and requirements; if required (*see 7.7*);
- k) Any other special requirement/test;
- m) Preservation, packing, and packaging requirements, if different; and
- n) Any special marking requirements, if different (*see 13.1*).

5 RAW MATERIALS FOR MANUFACTURE OF SOLDER ALLOYS

Refined non-ferrous metals shall be used for manufacture of soft solder alloys, which permit the solder alloy product to conform to the specified requirements. The use of recovered or recycled metal is encouraged for manufacture of solder alloys as far as possible. Recovered or recycled metals should conform to or exceed the chemical requirements of suitable grades (for manufacture of solder alloys) of comparable Indian Standards for pure virgin (previously unalloyed) refined metals (*see IS 209 for zinc; IS 27 for lead; IS 26 for tin; IS 17278 or IS 2279 for silver; IS 191 for copper; IS 6344 for cadmium; IS 211 for antimony etc.*) or any other international/industrial specifications.

NOTE— For lead, it is recommended to use the clean scrap free from radioactive contaminants and as far as possible lead produced from ore or similar raw materials shall be used.

6 SOLDER ALLOY

6.1 Solder Alloy Designation

Solder alloy used for solid wire and for the solder component of flux cored solder wire, shall be designated in accordance with solder alloy designations given in IS 193.

6.2 Chemical Composition of Solder Alloy

6.2.1 The solder component of the solid or flux cored solder wire shall conform to the appropriate alloy

composition given in IS 193, or IS 5479, or any other composition as mutually agreed between the purchaser and the supplier subject to the maximum percentage of impurities specified in 6.2.2, when chemically analyzed in accordance with the methods specified in relevant parts of IS 998 or any other instrumental/wet chemical methods as agreed between the purchaser and the supplier. In case of dispute, the wet chemical analysis either traditional wet chemical or instrumental shall be used as a referee method.

NOTE — The recommended method of analysis is IS 998. Unless the determination of particular element is not covered for the soft solder in IS 998, it is recommended to use ICP-OES method. Other acceptable analysis methods are Spark OES and AAS.

6.2.2 Unless otherwise agreed between the purchaser and supplier, the percentage by mass of impurity elements in alloys shall not exceed the values shown in Table 1. However in any case, be it as agreed or otherwise, except Note 3 of Table 1, the solders shall not contain lead, mercury, and cadmium beyond a maximum concentration value of 0.1 per cent by mass in solder alloy for lead, mercury, and of 0.01 per cent by mass in solder alloy for cadmium.

Table 1 Percentage by Mass of Impurity Elements in Alloys
(Clause 6.2.2)

Sl No.	Elements	Ag	Cd	Pb	Al	Cu	Sn	As	Fe	Zn	Au	In	Sb	Bi	Ni
(1)	(2)	(3)	(4)	(5)	(6)	(7)	(8)	(9)	(10)	(11)	(12)	(13)	(14)	(15)	(16)
i)	Percentage of Impurities, percent, m/m	0.10	0.02	0.07	0.005	0.08	0.25	0.03	0.02	0.003	0.05	0.10	0.20	0.10	0.01

NOTES

1 If agreed upon by the purchasers and supplier, a lead content upto 0.10 percent can be allowed (which is the maximum limit for declaring a solder lead free) and shall not serve a reason for non-conformance with this standard if the limits for lead exceed 0.07 percent.

2 The mercury if present as an impurity shall not exceed 0.1 percent.

3 The limits will not apply, in case, the main alloying element are the above elements.

7 FLUX

7.1 General Characteristics of Flux of Flux Cored Solder Wire

7.1.1 Solder Core Construction Requirements

7.1.1.1 Unless otherwise specified, the core(s) of flux-cored solders may be of any construction, provided it is (they are) continuous, uniform in cross-section, and symmetrically disposed in the solder wire. This shall be visually examined by the methods given in 7.1.1.2.

7.1.1.2 Unless otherwise agreed, carefully cut three pieces (approximately 50 mm long) of flux-cored wire at approximately 0.5 m intervals from each spool, coil, or cut length (from the 2 m wire cut for dimensional measurement test as given in Annex H), as applicable, in accordance with methods as agreed between purchaser and supplier. The recommended methods are given in 7.1.1.2.1 and 7.1.1.2.2. Using magnification

as needed, visually examine both ends of each 50 mm for core continuity, homogeneity, and condition and it shall meet the requirements of **7.1.1.1**.

7.1.1.2.1 *Wire solder up to approximately 6 mm diameter*

Hold the wire solder under tension with the point desired for the separation over a luminous flame such as is emitted by a match. The solder will snap apart at the point of hot shortness providing clean breaks, which will expose the flux core shapes as well as the flux continuity. This method of solder separation should be tried on small diameter wire solders to see if it will work satisfactorily before using the method in **7.1.1.2.2**.

7.1.1.2.2 *Wire solder larger than approximately 6 mm diameter*

Using a very sharp cutting edge, such as a strong razor blade, carefully cut the solder making special efforts to minimize the distortion in the solder by the cutting force.

7.2 Flux Classification and Characterization Testing

7.2.1 Fluxes used in the manufacture of solder products shall conform to the requirements of appropriate flux types given in Annex D. Fluxes shall have been fully tested, classified and characterized, and shall have not been altered since being tested except for the addition of inert plasticizers. The classification of fluxes covered by this standard are given in Table 6 of Annex D.

7.3 Flux Percentage or Flux Content

When tested in accordance with the method given in Annex E, the nominal flux contents and their permitted range, for flux cored solder wires shall be as given in Table 2. However, other nominal flux contents may be specified, subject to agreement between the purchaser and the supplier. In all cases, the permitted range shall be based on a tolerance of ± 0.15 percent for nominal contents 1.0 percent and less, and ± 0.3 percent for nominal contents above 1.0 percent.

Table 2 Recommended (preferred) nominal flux contents in mass percentage
(Clause 7.3)

SI No.	Recommended nominal content	Permitted range	
		Minimum	Maximum
(1)	(2)	(3)	(4)
i)	NIL	—	—
ii)	1.0	0.85	1.15
iii)	1.5	1.2	1.8
iv)	2.0	1.7	2.3
v)	2.5	2.2	2.8
vi)	3.0	2.7	3.3
vii)	3.5	3.2	3.8
viii)	4.0	3.7	4.3

7.4 Acid Value

7.4.1 To examine the organic acid content in flux that affects the solderability and corrosiveness of RO,

RE and OR base fluxes, acid value shall be determined in accordance with Annex T.

7.4.2 The determination of acid value shall be done for RO, RE, and OR (water and non-water soluble) type only. The acid value of RO based fluxes (which includes R, RMA, RA, RSA) shall have a minimum acid number of 130 mg KOH/g of non-volatile matter and shall be within ± 10 percent of the declared nominal acid value in mg KOH/g non-volatile content, when determined in accordance with test procedure given in Annex T. The acid number of other types of fluxes shall be as agreed between the purchaser and supplier and shall be tested in accordance with test method given in Annex T, and the values shall be within ± 10 percent of the agreed nominal acid value in mg KOH/g non-volatile content.

7.5 Flux Residue Dryness/Tackiness Test

The dryness characteristics of the reflowed residue of fluxed solders shall be determined in accordance with Annex G . When a fluxed solder/cored solder wire is tested in accordance with test method given in Annex G , the flux residue of ‘no-clean’ solders and, when specified, other flux type solders, shall be free of tackiness (‘not tacky’). Generally, this test is applicable for L and M type fluxes.

7.6 Spread Test (Optional)

When specified by the purchaser, the spread test of the flux in solder wire shall be determined in accordance with test method given in Annex F and spread area or spreadability percentage as determined with Annex F shall be as agreed between the purchaser and supplier. The spread test is not a pass/fail test, but rather is one that measures the relative wetting strength and surface tension characteristics of fluxes.

7.7 Halogen Content Test (Optional)

When reporting of halogen content is requested by the purchaser, the concentration of Cl and Br shall be determined using the oxygen bomb method followed by ion chromatography. Alternate test methods may be used as agreed between the user and supplier. Halogen levels measured are impacted by the sample preparation method selected; therefore, specific sample preparation details shall be included in the test report (*see* Annex C). Flux materials that do not contain metal shall be tested in the final reflowed residue form. Samples that contain metal shall be reflowed or extracted to obtain the flux residue portion of the material. The metal must be discarded and weight of the metal should not be considered in the calculation for halogen content. Alternate sample types (for example testing of raw flux) may give varying results and shall be as agreed between user and supplier. A flux residue is considered low halogen if the maximum halogen values are in accordance with Table below.

<i>Sl No.</i>	<i>Element</i>	<i>Maximum Quantitative Halogen in Low Halogen Materials</i>
(1)	(2)	(3)
i)	Bromine	≤ 1000 ppm
ii)	Chlorine	≤ 1000 ppm

NOTE — Halide versus Halogen content: Ion chromatography or titration methods, are intended for the detection of ionic halides. Ionic halide content is not to be confused with halogen content. Halogen content should be tested per EN 14582 or as agreed between user and supplier. An Oxygen Bomb is utilized to dissociate the covalently bound halide and this product

is dissolved and analyzed via ion chromatography. For additional information see 'A review of test methods and classifications for halogen-free soldering materials by Jasbir Bath, Gordon Clark, Tim Jensen, Renee Michalkiewicz and Brian Toleno published in the 2011 IPC, APEX conference proceedings'.

8 DIMENSIONS AND TOLERANCES

8.1 The recommended (or preferred) nominal sizes of solid flux cored solder wire, which are generally available and the associated tolerance values are given in Table 3.

Table 3 Recommended (Preferred) Outer Nominal Diameter and Associated Tolerances
(Clauses 8.1 and 8.2)

Sl No.	Outer Nominal Diameter, mm	Reference Outer Nominal Diameter, mm	Tolerance, mm	Standard mass per coil in Kg of flux cored wire (for information only)
(1)	(2)	(3)	(4)	(5)
i)	0.3	0.30	±0.03	0.25
ii)	0.4	0.40		±0.05
iii)	0.5	0.50	0.25, 0.5, 1, 2	
iv)	0.6	0.60		
v)	0.7	0.70		
vi)	0.8	0.80		
vii)	1.0	1.00		
viii)	1.2	1.20		
ix)	1.5	1.50		
x)	1.6	1.60		
xi)	2.0	2.00		
xii)	2.3	2.30		1, 2, 5
xiii)	2.5	2.50		
xiv)	3.0	3.00	±0.15	

8.2 When tested in accordance with Annex H, the mean/nominal outer diameter (that is the average of the maximum and minimum diameters at any one cross-section of the wire) at each location shall conform to the tolerances given for appropriate nominal diameter in accordance with Table 3.

8.3 Other nominal diameters may be specified, subject to agreement between purchaser and supplier. In all cases, the actual diameter at each location of the wire shall not vary from the specified diameter by more than, ± 0.03 mm for nominal diameters ≤ 0.5mm ; ± 0.05 mm for nominal diameters ≤ 2.5 mm and ; ± 5 percent for nominal diameters above 2.5 mm and shall be tested in accordance with Annex H.

9 SAMPLING FOR TESTS

The sampling method shall be as agreed between the manufacturer and purchaser for determination of chemical analysis of solder, properties of flux core etc. The recommended method of sampling is given below which may be used upon agreement between the purchaser and the supplier:

9.1 Sampling for Chemical Analysis of the Solder Alloy

9.1.1 Select batch sample from the batch/lot of flux cored solder wire in accordance with the **9.3.1**.

9.1.2 Using the batch sample in **9.1.1**, from each unit of product in the batch sample take, at random, a portion having a nominal mass of 10 g. Place all the portions taken to represent the batch into a silica crucible or *Pyrex* glass beaker or any other suitable heat resistant borosilicate glass beaker capable of withstanding the melting temperatures. Melt the aggregated portions and heat the melt to between 50 °C and 100 °C above the liquidus temperature of the alloy. After the flux has risen to the top, the alloy is poured carefully into a SS mould (for lead containing) or cast iron (for lead free) or any other mould at the discretion manufacturer of the shape given in Fig. 1 (care should be taken to allow the flux and alloy to separate completely), and chill-cast one test sample stick, approximately 50 g to 100 g in mass and not more than 8 mm thick, in SS mould (for lead containing) or cast iron (for lead free) or any other mould at the discretion manufacturer of the shape given in Fig. 1, for every 100 g of melt. The sample stick is then cleaned of flux residue using a suitable solvent as recommended by the manufacturer in which the flux is soluble. If the melted portions have a total mass of less than 50 g, then pour the whole melt into one of the cavities in the mould. If the mass of the consignment is too small for this procedure to be practicable, then the procedure for sampling should be agreed between the supplier and the purchaser.

9.1.3 Cut each test sample stick, obtained as described in **9.1.2**, in half transversely and take sufficient transverse slices from the middle portion of each stick to give a total mass of between 10 g and 20 g. Place all the slices into a clean fire clay crucible and add flux such as palm oil, glycerol, rosin or paraffin wax. Melt the slices and heat the melt to between 50 °C and 100°C above the liquidus temperature of the alloy solder. Stir well and invert the crucible at a height of approximately 50 cm above a dry, clean, smooth steel plate, having dimensions greater than 50 cm × 50 cm. The 'splash sample' obtained, which should be in the form of a foil suitable for cutting with scissors, constitutes the analysis sample representative of the batch.

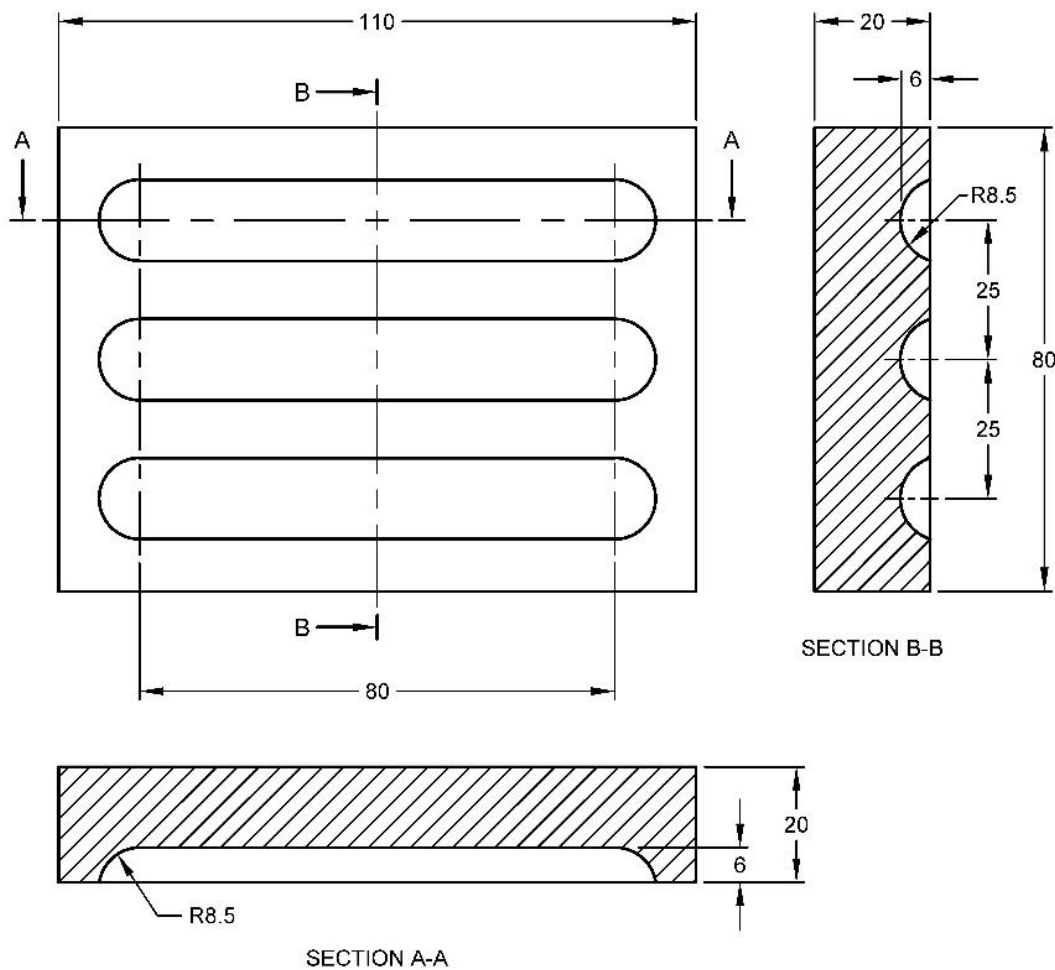

All dimensions in millimetres.

FIG.1 MOULD FOR CASTING THE TEST SAMPLE STICKS

9.1.4 Preservation of Analysis Sample

Cut the 'splash sample' into small pieces with scissors, degrease them with acetone and dry in a stream of warm air. Keep the sample pieces until required in a sealed airtight container, having a label giving full details of the origin of the sample.

9.2 Sampling for Tests to Determine the Properties of the Flux Core

Select batch sample at random from each batch of flux cored solder wire to be tested. The batch sample size shall be so selected to give the sufficient amount of final analysis sample solution, suitable for performing the tests to determine the properties of the flux core.

Extract the flux from the batch sample, following the procedure given in Annex A. Adjust the flux concentration of the resulting solution, by dilution or evaporation, to that required in the relevant test methods given in this standard.

9.3 Sampling for Tests to Determine the Flux Content and the Diameter of the Solid and Flux Cored Solder Wire

9.3.1 Select batch sample from the batch of solid and flux cored solder wire, as follows:

- a) Where the batch consists of up to 4 units of product (reel, coil or pack), select all units;
- b) Where the batch consists of over 4, up to and including 44 units of product, select at random 4 units; and
- c) Where the batch consists of n units of product ($n > 44$), select at random 0.1 n units (to the nearest integer above 0.1 n).

9.3.2 From each selected unit, cut back approximately 2 m from the free end of the wire and then cut a test specimen, approximately 2 m in length, for the determination of flux content and wire diameter.

10 RETEST AND REJECTION

If a sample selected for testing fails to meet the specified requirements, the purchaser or his representative shall select two more samples from the same lot/batch. If on testing either of these samples fails to meet the specified requirements, the lot may be rejected. In case of dispute or in the absence of agreement, both party shall have the right to have the solder sampled and tested by an independent authority mutually agreed upon and its decision shall be binding.

11 TESTING FREQUENCIES

The manufacturer shall perform such tests on the flux cored solder wires during its production as enumerated in this standard at the frequencies given in Table below to insure that the process is in control and the final product conform to this standard. The sampling method to be followed shall be as given in 9.

<i>Sl No.</i>	<i>Parameters</i>	<i>Nature of Test</i>	<i>Frequency</i>
(1)	(2)	(3)	(4)
i)	Diameter	Routine	Every lot / Control unit
ii)	Acid number/Acid value	Routine	Every lot / Control unit
iii)	Halide content	Routine	Every lot / Control unit
iv)	Flux percentage	Routine	Every lot / Control unit
v)	Alloy composition (solid / flux-cored)	Routine	Every lot / Control unit
vi)	Copper mirror test	Initial stage	During New Product Development (NPD) or Once in a year, whichever is earlier.
vii)	Copper plate corrosion test	Initial stage	
viii)	SIR test	Initial stage	
ix)	ECM test (optional)	Initial stage	

x)	Spread test	Initial stage	
xi)	Tackiness test/ Residue dryness test	Initial stage	

12 PACKAGING

The solid/ flux cored solders shall be wound on a reel or wound in a coil and shall be suitably packaged to prevent contamination or damage during transportation or storage.

13 MARKING

13.1 Each solid and flux cored solder wire shall be legibly marked with the following minimum information on the side of the reel when wound on a reel and on the tag attached to the coil when wound in a coil:

- a) The manufacturer's name/trademark and address;
 - b) Grade of solder alloy;
 - c) Nominal size of wire;
 - d) Classification of flux — as per flux identification system given in Table 6 of Annex D (applicable to flux cored solder wire);
 - e) Flux percentage (applicable to flux cored solder wire);
 - f) Net mass of solder wire;
 - g) Batch or Lot No.;
 - h) Date(s) of manufacture;
 - j) Shelf life/Expiry (applicable to flux cored solder wire);
 - k) If any, applicable health and safety markings, including indicative lead free or lead containing marking, as given in relevant *Acts, rules, regulations or bye laws existing in the Union of India*; and
- m) Any other markings or labelling as agreed between the purchaser and supplier.

13.2 BIS Certification Marking

The product(s) conforming to the requirements of this standard may be certified as per the conformity assessment schemes under the provisions of the *Bureau of Indian Standards Act, 2016* and the Rules and Regulations framed thereunder, and the products may be marked with the Standard Mark.

ANNEX A

(Foreword, Annex B and Clauses 1, 9.2, D-2.1, D-4.1.3.2, J-5, J-6.4, L-3, M-1.2.1, P-7.3.3.1, T-3.4.1.1 and T-4.4)

FLUX EXTRACTION PROCEDURE AND DETERMINATION OF MASS OF FLUX FOR FLUX CORED SOLDER WIRE

A-1 GENERAL

A-1.1 The methods of flux reflow and solvent extraction of the flux core of the solder wire produces a flux solution, which may be used for carrying out tests such as acid value, copper mirror, halides, SIR and ECM test on the flux core, as described in various Annexes of this standard. The method described yields only sufficient flux test solution for a single determination. Alternatively, a flux sample obtained from a flux supplier may be used to prepare a solution of 25 percent (mass fraction) solids of flux in 2-propanol or any other solvent recommended by supplier in which the flux is soluble for carrying out the required tests, which require the flux in solution form.

A-1.2 The type of method used shall be at the discretion of the manufacturer unless otherwise agreed between the purchaser and supplier.

A-2 METHODS OF FLUX EXTRACTION FROM CORED WIRE

A-2.1 Method A

Cut a length of wire to correspond to approximately 150 g. Seal the ends with a soldering iron. Wipe the surface clean with a cloth moistened with 2-propanol. Wind the wire around a 50 mm mandrel. Place the coil into a beaker filled with deionized water to cover the coil and boil for 5 min to 6 min. Decant, rinse the coil with 2-propanol and dry. Cut the wire into approximately 3 mm lengths with a sharp blade. Discard the sealed ends of the wire. Two containers are required. Container No. 1 may be a test tube or small beaker. Preferably, container No. 2 should be a low-profile container, such as a petri dish or watch glass, to enhance heat transfer.

Label container No. 1 and record its mass (m_1) to the nearest 0.001g. Place the accumulated 3 mm lengths in container No. 2 and hold in a solder bath maintained at 215 °C for 20 s beyond the time required for the pool of liquid solder alloy to form. While the solder is molten, carefully pour the liquefied hot solder-cored flux into container No. 1 and allow to cool. Weigh container No. 1 (m_2) to the nearest 0.001g, to determine the mass of the reflowed cored-solder flux by following formula:

$$\text{Mass of flux} = m_2 - m_1$$

Add an excess amount of 2-propanol or other suitable solvent recommended by the manufacturer such that after evaporation a 25 percent (by weight) solution of reflowed cored solder flux will result. Determine the non-volatile matter content of the extract using the method in Annex L.

Testing for flux activity will be done on material as a 25 percent weight percent solution in 2-propanol, reagent grade (or other solvent recommended by the supplier). For low-solid, no-clean fluxes a 25 percent

(by weight) solution shall be used. Stir or agitate the mixture as required. If a flocculent precipitate results, this precipitate should be allowed to settle and the supernatant liquid used for subsequent tests. Store the solution in a closed container.

A-2.2 Method B

A-2.2.1 General

This method for the solvent extraction of the flux core of the solder wire produces a flux solution, which may be used for carrying out tests on the flux core, as described in this standard for its characterization. The method described yields only sufficient flux test solution for a single determination. Alternatively, a flux sample obtained from a flux supplier may be used.

A-2.2.2 Principle

The flux is extracted from the cored wire with an appropriate solvent to give a solution of the flux for testing purposes.

A-2.2.3 Reagents

Use only reagents of recognized analytical grade and only distilled, or deionized, water and in particular the following:

- a) Acetone [reagent (lab) grade]; and
- b) Propan-2-ol [reagent (lab) grade].

NOTE — If the flux is not soluble in propan-2-ol, then use another suitable solvent. For example, water should be used in the case of a water-soluble flux.

A-2.2.4 Apparatus and Instruments

Ordinary laboratory apparatus and, in particular, the following.

- a) Laboratory balance, with an accuracy of 0.001 g;
- b) Scalpel;
- c) Soxhlet extraction apparatus, equipped with a sintered glass extraction thimble, porosity 40 μm to 100 μm (that is porosity grade P100 specified in IS 12305/ISO 4793); and
- d) Drying oven, suitable for use at $(100 \pm 5) ^\circ\text{C}$.

A-2.2.5 Procedure

- a) Ascertain the approximate mass of solid flux required in the test methods mentioned in this part of the standard to be carried out; and
- b) Using the informative Table below, take a sufficient sample of the cored wire to provide the required mass of flux.

<i>Sl No.</i>	<i>Nominal Mass Flux Content of Cored Wire, Percent</i>	<i>Mass of Wire in Grams Containing Approximately 1 g of Flux</i>
---------------	---	---

(1)	(2)	(3)
i)	0.3	300
ii)	0.5	200
iii)	1.0	100
iv)	1.5	75
v)	2.0	50
vi)	3.0	35
vii)	3.5	30

- c) Wipe the surface of the sample clean with a cloth moistened with acetone [A-2.2.3 a)].
- d) Protecting the solder surface from contamination, cut the sample into 3 mm to 5 mm lengths, using the scalpel A-2.2.4 b), so as not to crimp the cut ends. Carry out this operation on a sheet of glossy paper, or on a white tile on a sheet of paper, so as not to lose any flux debris.
- e) Weigh the sintered glass extraction thimble [A-2.2.4 c)], carefully transfer all of the cut pieces of wire and flux debris to the thimble, and re-weigh, both weighings being carried out to the nearest 0.001 g. Calculate the mass of the sample used (m), in grams.
- f) Carefully transfer the extraction thimble containing the cored wire pieces to the tube of a clean Soxhlet extraction apparatus [A-2.2.4 c)].

NOTE — Larger samples may need to be split into two or more portions for Soxhlet extraction, depending on the capacity of the Soxhlet apparatus, the resulting extracts being aggregated and mixed.

- g) Pour a quantity of propan-2-ol [A-2.2.4 b)], or any other suitable solvent [see Note to A-2.2.3 b)], into the distillation flask of the Soxhlet extraction apparatus [A-2.2.4 c)]. The volume of solvent to be used shall be sufficient to just overflow the thimble. Extract the flux into the solvent for a minimum of 30 minutes.

NOTE — The extract should be colourless.

- h) Carefully decant the solvent containing the flux into a graduated 400 ml beaker rinsing three times with the solvent, to ensure all the flux has been transferred.
- j) Rinse the Soxhlet extraction tube and the sintered glass thimble two or three times with 10 ml amounts of the solvent. Collect all the solvent used and add it to the flux solution in the 400 ml beaker.
- k) Dry the extraction thimble [A-2.2.4 c)] in the drying oven [A-2.2.4 d)] at $(100 \pm 5)^\circ\text{C}$, cool and reweigh, to the nearest 0.001 g. Calculate the mass of the “defluxed” solder wire sample, m_m , in grams.
- m) Then the mass of flux, in grams, in the original sample is given by:

$$\text{Mass of flux} = m - m_m$$

- n) Adjust the non-volatile matter content of the extract in the 400 ml beaker by evaporation or by dilution with the solvent used during the extraction stage, to (25 ± 2) percent by mass to produce the flux test solution. The non-volatile matter content of the extract shall be determined using the method in Annex L.

ANNEX B
(Clauses 1 and 7.3)

GUIDANCE ON FORM OF THE TEST SPECIMEN OF FLUX TO BE USED FOR CLASSIFICATION TESTING

B-1 The forms of the test specimen of flux to be used for each classification test and other tests are shown in Table 4 below.

Table 4 Preparation of Flux Forms for Testing
(Clause B-1)

Sl No. (1)	Test Methods (2)	Test Method Reference (3)	Main Purpose of the Test Method (4)	Test Specimen (5)
i)	Copper mirror	Annex J	In order to examine the corrosiveness of flux, the degree of corrosion of copper on the copper mirror is compared with that of the standard rosin solution (WW rosin) for evaluation.	Extracted flux solution (as per Annex A)
ii)	Corrosion (Copper plate corrosion test)	Annex K	In order to examine the corrosiveness of flux residue after soldering, the discolouration of flux residue or the presence of corrosion product on a copper plate is evaluated.	Product itself.
iii)	Halides	Annex M and Annex N	The halide content in flux that affects the solderability and the corrosiveness is measured.	Extracted flux solution (as per Annex A, preferably Method A)
iv)	SIR	Annex P and Annex Q	In order to examine the reliability of flux, the insulation resistance is measured under high temperature	Product itself and soldered with solder iron/ Extracted flux solution

		and high humidity condition using comb-patterned printed circuit boards.	
v) ECM	Annex P and Annex Q	In order to examine the occurrence of electrochemical migration that affects the reliability of flux, flux applied on comb-patterned printed circuit board is tested by leaving the circuit board under high temperature and high humidity condition to stand for a specified time with bias voltage applied, and the presence of metal dendrites is examined.	Product itself and soldered with solder iron/ Extracted flux solution.
vi) Solids content	Annex L	The solid content that affects the solderability of liquid flux and the amount of flux residue is measured that will be left after soldering. The low residue no clean solders have less than 15 percent solids content.	Extracted flux solution (as per Annex A)
vii) Acid value	Annex T	In order to examine the organic acid content in flux that affects the solderability and the corrosiveness, the acid value is measured.	Extracted flux solution (As per Annex A)

viii)	Flux content/Flux percentage	Annex E	The flux content that affects the solderability of flux cored solder is measured.	Product itself
ix)	Spread test	Annex F	In order to examine the solderability of flux cored solder, the flux effect is evaluated by the solder spread characteristics.	Product itself
x)	Tackiness test/Residue dryness test	Annex G	The dryness of flux residue that affects the finishing quality after soldering is examined.	Product itself

NOTES

- 1 Product must be tested using a Sn-Pb or Pb-free profile based composition of solder alloy of flux cored solder wire.
 - 2 Testing for flux activity will be done on material as a 25 percent weight percent solution in 2-propanol, reagent grade (or other solvent recommended by the supplier).
-

ANNEX C

(Clauses 1, 7.7, D-4, D-4.1.4.1, D-4.1.5.1, P-7.4.2 and Q-7.3.2 and Annex S)

GUIDANCE ON THE TEST REPORT OF FLUX OF FLUX CORED SOLDER WIRE

Classification Tests	Clause/Table/Paragraph Requirement	Test Method	Test Requirement		Result				Classification
Copper mirror	Table 7 Col 1, and D-4.1.1	Annex J	No breakthrough	L					L
			<50percent breakthrough	M					M
			Greater than or equal to 50percent breakthrough	H					H
Quantitative halide	Table 7 Col 3, and D-4.1.3	Annex M	<0.5percent	L	Cl- =	Br- =	F- =	I- =	L
			≥0.5 to <2.0percent	M					M
			≥2.0percent	H					H
					Total Halide as chloride=				
Copper plate corrosion	Table 7, Col 2, and D-4.1.2	Annex K	No Corrosion	L					L
			Minor Corrosion	M					M
			Major Corrosion	H					H
SIR	Table 7 Col 4, and D-4.1.4	Annex N	No-clean state ≥ 100 MegaOhm	L					L
			Cleaned or No-clean state ≥ 100 MegaOhm	M					M
			Cleaned ≥ 100 MegaOhm	H					H
ECM (optional)	Table 7 Col 5, and D-4.1.5	Annex P	No-clean ≤1 decade drop	L					L
			Cleaned or no-clean ≤1 decade drop	M					M
			Cleaned ≤1 decade drop	H					H
What is the highest classification rating listed above?								L M H	
What is the halide rating based on the percent halide as measured above or via qualitative halide test (silver chromate Clause D-4.1.3.1.1 and spot test Clause D-4.1.3.1.2) ?			<0.05percent	0				0	
			>0.05percent	1				1	

Final Flux Classification : *Refer to Col 5 of Table 6 and Clause D-2 for flux designators*

Characterization Tests	Reference Paragraph/Clause	Test Method	Result
Acid Value	3.23, 7.4.1, and 7.4.2	Annex T	
Solids Content (Non-volatile matter Determination)	D-4.1.3.2, K-2, K-6.2.2, M-1.2.1, T-3.5 and T-4.4	Annex L	
Spread Test (Optional)	7.6	Annex F	Spread Area/ Spreadability percentage
Halogen Content (Optional)	7.7	Oxygen Bomb + Ion Chromatography or as agreed b/w purchaser and supplier	

Required Information for Cleaned Product	
Cleaning Procedure for SIR/ECM Testing:	
Cleaning Material:	
Cleaning Equipment:	
Cleaning Process Parameters:	

Required Information for Halogen Determination	
Procedure used to extract metal, if applicable	
Reflow Profile	
Substrate used to collect reflowed sample residue	
Reflow Atmosphere	
Halogen Determination via Ion Chromatography	<p>Weight of ion (g) in sample = [Conc. of Ion in Extract (ug /mL)]x[Dilution Factor]x[Dilution Volume (mL)]x10⁻⁶</p> <p>Percent of ion in residue = (Wt of ion (g) in Sample/Wt (g) of Flux Residue) x 100</p>

ANNEX D

(Foreword, Clauses 7.2.1, 12.1, G-1, P-4.3, Q-1, Q-2 and Q-4.6.1)

FLUX CLASSIFICATION AND CHARACTERIZATION

D-1 FLUX DESIGNATION AND IDENTIFICATION SYSTEM

To facilitate ordering and designation based on specific requirements, the flux identification system (including both composition and flux type) given in Table 6 shall be utilized for flux classification.

Table 6 Flux Classification and Identification System

(Clauses 7.2.1, 13.1, D-1, D-2, D-2.1, G-1 and Annex C)

SI No.	Flux Composition	Flux/Flux Residue Activity Levels	Percent Halide ¹⁾ (by weight Cl ⁻ , Br ⁻ , F ⁻ , I ⁻)	Flux Type ²⁾	Flux Designator
(1)	(2)	(3)	(4)	(5)	(6)
i)	Rosin (RO)(Colophony or modified colophony)	Low	< 0.05 percent	L0	ROLO
			≥ 0.05 and < 0.5 percent	L1	ROL1
		Moderate	< 0.05 percent	M0	ROM0
			≥ 0.5 and < 2.0 percent	M1	ROM1
		High	< 0.05 percent	H0	ROH0
			≥ 2.0 percent	H1	ROH1
ii)	Resin (RE)	Low	< 0.05 percent	L0	RELO
			≥ 0.05 and < 0.5 percent	L1	REL1
		Moderate	< 0.05 percent	M0	REM0
			≥ 0.5 and < 2.0 percent	M1	REM1
		High	< 0.05 percent	H0	REH0
			≥ 2.0 percent	H1	REH1
iii)	Organic (OR) (Water soluble and non-water soluble both)	Low	< 0.05 percent	L0	ORLO
			≥ 0.05 and < 0.5 percent	L1	ORL1
		Moderate	< 0.05 percent	M0	ORM0
			≥ 0.5 and < 2.0 percent	M1	ORM1

		High	< 0.05 percent	H0	ORH0
			≥ 2.0 percent	H1	ORH1
iv)	Inorganic (IN)	Low	< 0.05 percent	L0	INL0
			≥ 0.05 and < 0.5 percent	L1	INL1
		Moderate	< 0.05 percent	M0	INM0
			≥ 0.5 and < 2.0 percent	M1	INM1
		High	< 0.05 percent	H0	INH0
			≥ 2.0 percent	H1	INH1

1) Halide measuring < 0.05 percent by weight in flux solids may be known as halide-free.

2) The 0 and 1 indicate the absence or presence of halides, respectively

D-2 CLASSIFICATION

As part of the qualification process, fluxes shall be classified according to the composition of the main ingredient and flux type. Flux designators identify both composition and type of fluxes (*see* Table 6). It is generally the responsibility of the flux suppliers to classify their flux in accordance with this standard.

D-2.1 Flux Composition

After extraction of the sample of flux from cored solder wire, as per Annex A, the composition shall conform to requirements of appropriate classification as given in Table 6. The flux shall be classified as either rosin, resin, organic or inorganic (*see* Table 6), based on the largest weight percent constituent of its nonvolatile portion.

NOTE — No-clean fluxes may have rosin compositions (symbol RO), resin compositions (symbol RE), or they may be substantially free of rosins and resins, in which case they are classified as organic type (symbol OR). They typically have type L or M activity levels. Water-soluble fluxes for electronic soldering applications and synthetic activated fluxes generally have organic compositions (symbol OR). They typically have type M or H activity levels. Inorganic (IN) fluxes are generally not used in cored solder wire unless agreed between manufacturer and user. The clean or no clean flux shall be decided based on the results of SIR and/or ECM test.

D-2.2 Flux Type

Based on flux activity and halide content, fluxes shall also be classified according to the corrosive or conductive properties of the flux or the flux residue. In order to be classified as a specific type, a flux must meet all the characterization requirements as shown in Table 7.

RO and RE flux normally have activity levels of L or M. Organic (OR) type fluxes, typically have type H activity level.

D-2.2.1 Flux Activity

The flux type shall be identified based on the ionic and corrosive activity of the flux and its residue. Fluxes shall be qualified as one of the following three types:

- a) L, 0 or 1 = Low or no flux/flux residue activity
- b) M, 0 or 1 = Moderate flux/flux residue activity
- c) H, 0 or 1 = High flux/flux residue activity

Table 7 Test Requirement for Flux Activity Classification
(Clause D-2.2)

SI No.	Flux Type	Copper Mirror Test	Copper Plate Corrosion Test	Quantitative Halide	Condition for Passing 100 MΩ SIR Requirement	Condition for Passing ECM Requirements
				(see Note 1) (Cl-,Br-,F-,I-) (by weight)		
(1)	(2)	(3)	(4)	(5)	(6)	(7)
i)	L0	No evidence of mirror breakthrough	No evidence of corrosion	< 0.05 percent (see Note 1)	No-clean state (see Note 3)	No-clean state (see Note 3)
ii)	L1			≥ 0.05 and < 0.5 percent		
iii)	M0	Breakthrough in less than 50 percent of test area	Minor corrosion acceptable	< 0.05 percent (see Note 1)	Cleaned (see Note 4) or No-clean state (see Note 3)	Cleaned (see Note 4) or No-clean state (see Note 3)
iv)	M1			≥ 0.5 and < 2.0 percent (see Note 2)		
v)	H0	Breakthrough in more than or equal to 50 percent of test area	Major corrosion acceptable	< 0.05 percent (see Note 1)	Cleaned	Cleaned
vi)	H1			≥ 2.0 percent (see Note 2)		

NOTES

- 1 Fluxes with halide measuring < 0.05 percent by weight in flux solid may be known as halide free.
- 2 Even if flux shows no corrosion, it is considered M1, if halide content is ≥ 0.5 percent and < 2.0 percent and, H1, if halide content is ≥ 2.0 percent.
- 3 Fluxes that are not meant to be removed require testing only in the no-clean state.
- 4 If the M0 or M1 flux passes SIR and ECM when cleaned, but fails when not cleaned, this flux shall always be cleaned.
- 5 The 0 and 1 indicate the absence or presence of halides, respectively.
- 6 The test for ECM can be omitted when agreed between the contracting parties.

It is possible that certain corrosive fluxes can meet one or more test for L type flux. However, failure to meet all test requirement will cause flux to be classified as either M type or H type.

D-2.2.2 Halide Content

Flux Type shall be identified using 0 or 1 to indicate the absence or presence of halide in the flux, where < 0.05 percent halide is defined as halide free. The qualitative test for assessing the absence or presence

of halide shall be conducted as per the test procedures given in Annex N, where the absence of halides indicates the passing of the test methods and the presence on halides constitute a *fail* result. If the result of the tests is *fail* (either silver chromate and /or spot test), the quantitative halide method outlined in Annex M shall be used to determine the amount of halide content (Cl⁻, Br⁻, I⁻, and F⁻) present. Testing for halide content does not include evaluation for halogen content. A material with a “0” indicator may contain non-ionic halogen. Ionic halide content is not to be confused with halogen content; we have to determine ionic halide content only and determination of halogen content is optional depending upon the requirement of the user (*see 7.7* for details).

NOTE — Ion chromatography is an acceptable test method for determination of quantitative halides (in addition to the quantitative halide content evaluation methods enumerated in Annex M) and can be also used as a referee method also.

D-2.2.3 Additional Information on Flux Activity

In order to illustrate an approximate, though not necessarily always accurate, analogy between L, M, and H type fluxes in **D-2.2** with the traditional classes of rosin-based fluxes (R, RMA, RA, and RSA), as well as other fluxes such as water soluble or synthetic activated fluxes, the following guideline is offered:

- a) L0 type fluxes— all R, some RMA, some low-solid ‘no-clean’;
- b) L1 type fluxes— most RMA, some RA;
- c) M0 type fluxes— some RA, some low-solid ‘no-clean’;
- d) M1 type fluxes— most RA, some RSA;
- e) H0 type fluxes— some water soluble; and
- f) H1 type fluxes— some RSA, most water soluble and synthetic activated.

D-4 QUALIFICATION TESTING

For qualification testing, the flux supplier shall perform or have performed testing in accordance with test requirements listed in **D-4** and complete a qualification test report (*see* Annex C for an example) which shall be available to customers upon request. Testing requirements in **D-4.1.1** to **D-4.1.5** classify/characterize the flux type, as per the requirements for each type listed in Table 7.

D-4.1 Classification/Characterization Testing

D-4.1.1 Copper Mirror Test

The corrosive properties of the flux shall be determined in accordance with Annex J. The flux shall be classified as type L only if there is no complete removal of the copper film. If there is any complete removal of the copper film, as evidenced by the background showing through the glass, then the flux shall not be classified as type L. If there is complete removal of the copper only around the perimeter of the drop (less than 50 percent breakthrough), then the flux shall be classified as type M. If the copper film is completely removed (greater than or equal to 50 percent breakthrough), then the flux shall be classified as type H. Fig. 1 shows examples of qualitative results for flux activity classification.

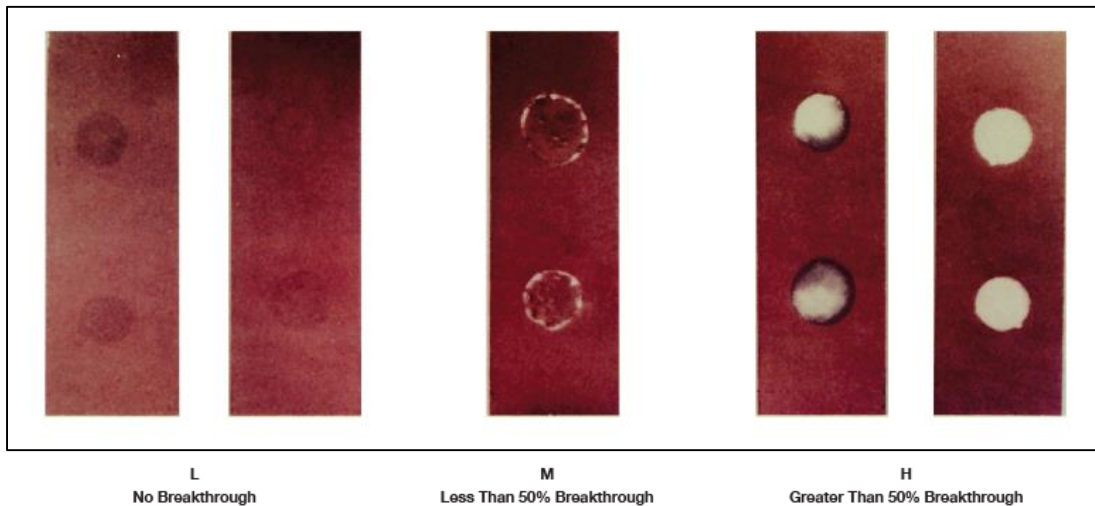

FIG. 1 FLUX TYPE CLASSIFICATION BY CORROSIVITY BY COPPER MIRROR TEST (SOURCE IEC 61189-5-2:2015)

D-4.1.2 Copper Plate Corrosion Test

This test method is designed to determine the corrosive properties of flux residues under extreme environmental conditions. The corrosive properties of flux residue shall be determined in accordance Annex K. For purposes of this test method, the following definition of corrosion shall apply ‘A chemical reaction between the copper, the solder, and the flux residues that occurs after soldering and during exposure to the above environmental conditions’. Corrosion is qualitatively assessed as follows:

No Corrosion — No evidence of corrosion is observed. Any initial change of color, which may develop when the test panel is heated during soldering, is disregarded as seen in Fig. A.1 a) and b).

Minor Corrosion — Discrete white or colored spots in the flux residues or a color change to green-blue without pitting of the copper is regarded as minor corrosion as seen in Fig. A.1 c).

Major Corrosion — Development of green-blue discoloration/corrosion with observation of pitting of the copper panel is regarded as major corrosion as seen in Fig. A.1 d) and e).

D-4.1.3 Halide Content Tests

D-4.1.3.1 Qualitative halide content test

The following tests are used to determine the presence of halides, specifically, chlorides (Cl), bromides (Br), and fluorides (F), in extracted flux solutions. To declare the flux as halide free, and to be designated as ‘0’ as per D-2.2.2, it shall pass both the silver chromate test outlined in D-4.1.3.1.1 and the spot test given in D-4.1.3.1.2. If the flux *fails* (that is halide is present) any of the qualitative halide content test outlined in D-4.1.3.1.1 and D-4.1.3.1.2, then quantitative halide content test procedures outlined in D-4.1.3.2 shall be performed to determine the exact content of halides (specifically Cl⁻, Br⁻ and F⁻).

D-4.1.3.1.1 Chlorides and bromides by silver chromate method

The presence of chlorides and bromides shall be determined in accordance with the relevant method given in Annex N.

D-4.1.3.1.2 Fluorides by spot test

The presence of fluorides shall be determined in accordance in accordance relevant method given in Annex N.

D-4.1.3.2 Quantitative halide content test

If the flux fails the test in **D-4.1.3.1** or **D-4.1.3.2**, the following respective tests shall be used to determine the concentration of chlorides, bromides, and fluorides in extracted flux solutions. The halide content is reported as the equivalent weight percentage of chloride to the solid (non-volatile) portion of the flux. The solids content is determined in accordance with Annex L. The total halide content of the flux is obtained by adding together the halide contents from sections **4.1.3.2.1** (Cl^- and Br^-) and **4.1.3.2.2** (F^-) and shall conform to the requirements of the appropriate classification flux type given in Table 7. Ion chromatography is an acceptable test method for determination of quantitative halides and may be used as a referee method.

NOTE — For quantitative analysis of halide content it is being recommended to use the extracted flux solution extracted in accordance with Method A of Annex A (reflowed residue). There is a growing practice of running ion chromatography/titration on reflowed flux residue in terms of sample preparation before Ion chromatography testing. There are two reasons that people typically utilize this type of method. First, they are examining the flux residues remaining on the PCB for any species that may lead to an increased occurrence of corrosion or dendrite growth from halide ions that do not volatilize. Secondly, any covalently bound halogens contained in the flux may disassociate during the reflow process and then the subsequent extraction and chromatography testing will detect these dissociated halogens as well as the halides that do not volatilize. Hence, the Method A of Annex A is the recommended procedure for obtaining the 25 percent m/m test solution for halide content testing after reflow.

D-4.1.3.2.1 Chloride and bromide concentrations

The combined concentration of chlorides and bromides shall be determined in accordance with the Annex M.

D-4.1.3.2.2 Fluoride concentration

For fluxes giving a positive result when tested as per **D-4.1.3.1.2**, the concentration of fluorides shall be determined in accordance with the Annex M.

D-4.1.4 Surface Insulation Resistance Test

The surface insulation requirements for fluxes shall be determined in accordance with the appropriate test method given in Annex P or Annex Q or by any other internationally accepted test method as agreed between purchaser and supplier. In case of dispute, the procedure given in Annex Q shall be the referee method.

The list of internationally accepted methods, which may be used, as agreed between the purchaser and the supplier, are given below:

- a) IPC TM-650, Test method 2.6.3.3 or 2.6.3.6
- b) IPC TM-650, Test method 2.6.3.7 except the test duration would be 168 hours
- c) ISO 9455-17 : 2024
- d) IEC 61189-5-501 : 2021

D-4.1.4.1 Reporting SIR test results

When specifying the SIR test results, the supplier **shall** clearly indicate if cleaning is required and the type of cleaning procedure to be used prior to SIR testing (*see Annex C Qualification Test Report*). The supplier:

Shall clearly indicate if cleaning is required.

Shall document the cleaning procedure used in preparing the SIR coupons.

Shall disclose thermal profile or solder pot temperature and preheat temperature.

D-4.1.4.2 SIR test criteria

The requirements for passing the SIR test are:

- a) All SIR measurements on all test patterns **shall** exceed the 100 MΩ requirement after 24 hours of exposure measured at interval of 96 h and 168 h, as given in Table 7.
- b) Control coupons **shall** exceed the 1000 MΩ requirement.
- c) There **shall not** be evidence of electrochemical migration (filament growth) that reduces the conductor spacing by more than 20 percent.
- d) There **shall not** be corrosion* of the conductors.

*NOTE: Minor discoloration of one pole of the comb pattern conductors is acceptable.

D-4.1.5 Resistance to ECM Test (Optional)

The resistance to ECM testing shall be assessed in accordance with appropriate test method given in Annex P or Annex Q or by any other internationally accepted test method as agreed between purchaser and supplier. In case of dispute, the procedure given in Annex Q shall be the referee method. The test shall be conducted for a period of 596 hours (96 hours stabilization without bias and 500 hours with applied bias). The test may be conducted for a period of 1 000 hours wherever agreed between the purchaser and supplier, but it is recommended to use the former test duration. Further, the test for ECM can be omitted when agreed between the contracting parties.

The indicative list of internationally accepted methods, which may be used, as agreed between the purchaser and the supplier are given below:

- a) IPC TM 650 , Test method 2.6.14.1
- b) ISO 9455-17 : 2024
- c) JIS Z 3197 : 2021

D-4.1.5.1 Reporting ECM test results

When specifying the ECM test results, the supplier **shall** clearly indicate if cleaning is required and the type of cleaning procedure to be used prior to ECM testing (*see Annex C Qualification Test Report*).

The IR_{initial}, or initial insulation resistance, is the data measurement taken after a 96 hour stabilization period. The IR_{daily}, the daily IR measurements and the final insulation resistance (IR_{final}) measurement values **shall** be reported according to the test method. The criteria for passing the ECM test are:

- a) The $IR_{\text{final}} \geq IR_{\text{initial}}/10$. That is, the IR **shall not** degrade by more than or equal to one decade, as a result of the applied bias;
- b) There **shall not** be evidence of electrochemical migration (filament growth) that reduces the conductor spacing by more than 20 percent; and
- c) There **shall not** be corrosion* of the conductors.

*NOTE: Minor discoloration of one pole of the comb pattern conductors is acceptable.

ANNEX E

(Foreword, Clause 7.3 and Annex B)

DETERMINATION OF FLUX CONTENT**E-1 SCOPE**

This test method specifies two methods for the determination of the flux content of a sample flux cored solder wire.

E-2 PRINCIPLE

A known mass of the sample of flux cored solder wire is melted, separated from the flux medium and weighed. The flux content is calculated and expressed as a percentage by mass of the original wire.

E-3 TEST SPECIMEN

Use approximately 200 grams of flux-cored solder for Method A; for Method B, use approximately 30 grams of flux cored solder wire. For fluxes, whose flux percentage is expected to be 1 percent or more, the test specimen may be approximately 100 grams. For fluxes whose flux percentage is expected to be 2 percent or more, the test specimen may be approximately 50 grams.

E-4 APPARATUS AND MATERIALS

- a) Degreasing solvent, such as 2-Propanol (Reagent (Lab) Grade) or the solvent recommended by the manufacturer;
- b) Balance, having an accuracy of ± 0.001 g;
- c) Porcelain crucible, capacity 30 ml;
- d) Crucible or beaker tongs / Holder ;
- e) Hot plate capable of being set to $50\text{ }^{\circ}\text{C} \pm 5\text{ }^{\circ}\text{C}$ above the liquidus temperature of solder sample alloy;
- f) Tissues or wipe cloth;
- g) Glycerol; and
- h) Glass beaker – *Pyrex* or heat resistant Borosilicate glass, 100 ml - 150 ml.

E-5 PROCEDURE

Clean the sample length of the flux cored solder wire under test with a tissue or wipe soaked in the degreasing solvent. Follow either method A or method B below.

E-5.1 Method A

Carry out the test in duplicate.

E-5.1.1 Determine the approximate liquidus temperature of the solder alloy from IS 193.

E-5.1.2 Weigh the cleaned solder specimen to nearest of 0.001 g (W_1).

E-5.1.3 Carefully pack the solder specimen as tightly as possible in the bottom of the beaker. Using the balance weigh cleaned wire along with beaker to the nearest 0.001 g (W_2). Record the Weights.

E-5.1.4 Preheat the hot plate to $50\text{ }^\circ\text{C} \pm 5^\circ\text{C}$ above the liquidus temperature of solder specimen alloy.

E-5.1.5 Place the beaker with the solder specimen on the hot plate. Remove the beaker as soon as all of the solder melts and allow the solder melt to cool at room temperature for about 30 min.

NOTE — Do not super cool the solder, as the solder will become tight intact to the beaker.

E-5.1.6 Using reagent grade 2-Propanol or other suitable solvent recommended by the solder manufacturer, some slight agitation, and gentle heat, thoroughly extract the flux residues from the beaker. Decant the extraction solution through coarse filter paper, taking care that no solder escapes the beaker. Repeat the extraction procedure as necessary to remove all traces of flux residue. Evaporate the remaining solvent from the beaker by warming under gentle steam of air until the residue in the beaker is completely dry.

E-5.1.7 Weigh the beaker and the melted solder metal to nearest 0.001 grams (W_3).

E-5.1.8 Repeat the flux extraction procedure until a constant final weight (W_3) is obtained.

E-5.2 Method B

Carry out the test in duplicate.

E-5.2.1 Using the balance, weigh $30\text{ g} \pm 2\text{ g}$ of the cleaned wire to 0.001 g. Record the mass of the sample (W_1).

E-5.2.2 Transfer the solder wire to the beaker, with sufficient glycerol/glycerine to cover the sample (approximately 50 ml of glycerol). Heat to $50\text{ }^\circ\text{C} \pm 5^\circ\text{C}$ above the liquidus temperature of the wire under test.

E-5.2.3 Turn the beaker until the solder has melted into one pellet. Leave the beaker on the hot plate bath for 10 s - 15 s after the solder has melted, while turning gently.

E-5.2.4 Allow the solder to solidify and then decant as much of the flux/glycerol mixture as possible from the molten solder. Allow the solder to cool and solidify.

E-5.2.5 Remove the solder pellet and wash it in water. Clean it thoroughly with degreasing solvent to remove all traces of flux. Dry the pellet with a clean tissue.

E-5.2.6 Using the balance, measure the mass of the dry pellet to a constant weight, to 0.001 g (W_2).

NOTE — In cases of dispute. It is recommended that the method to be used be agreed between supplier and purchaser.

E-6 EXPRESSION OF RESULTS FOR BOTH METHODS

E-6.1 Calculate the flux content (in percent m/m) of the sample wire as the percentage by mass, using the following formula:

Method A:

$$\text{Flux content} = \left[\frac{W_3 - W_2}{W_1} \right] \times 100$$

where

W_1 is the mass, in grams, of the flux cored solder wire used in the test;

W_2 is the mass, in grams, of the flux cored solder wire and the beaker; and

W_3 is the mass, in grams, of the melted solder (after removal of flux residues) and the beaker.

Method B:

$$\text{Flux content} = \left[\frac{m_1 - m_2}{m_1} \right] \times 100$$

where

m_1 is the mass, in grams, of the flux cored solder wire used in the test; and

m_2 is the mass, in grams, of the solder pellet.

E-6.2 If the values of the two determinations differ by more than 0.2 percent, the determination shall be repeated completely.

E-6.3 Calculate the arithmetic mean of the two determinations.

E-7 TEST REPORT

The test report shall include the following information:

- a) The identification of the test sample;
- b) The test method used;
- c) The results obtained;
- d) Any unusual features noted during the test; and
- e) Details of any operation not included in this this method, or regarded as optional.

ANNEX F

(Foreword, Clause 7.6 and Annex B)

SPREAD TEST OF EXTRACTED CORE WIRE**F-1 OBJECTIVE OF THE TEST METHOD**

This test is a standard method of determining the spreadability of solder affected by the performance of flux, as follows. This test method gives an indication of activity of cored solder or preform fluxes. This method is applicable to all types of fluxes be its RE, RO, OR or IN flux compositions.

This test method offers two evaluation methods:

- a) Method A measures the solder spread area; and
- b) Method B measures the solder spread ratio.

F-2 PRINCIPLE

A certain volume of solder and flux is placed on an oxidized copper plate and heated. After fusing, the effect of flux is evaluated by measuring the spreadability or the spread area of solder.

F-3 TEST SAMPLE

The product itself shall be used. Cut approximately $0.30 \text{ g} \pm 0.03 \text{ g}$ of the sample from the flux cored solder wire.

F-4 REAGENTS AND MATERIALS

Use only reagents of recognized analytical grade and distilled or demineralized water or water of equivalent purity.

F-4.1 Degreasing Agents such as a suitable neutral organic solvent such as acetone, ethanol, methanol or petroleum ether.

F-4.2 2 –Propanol

F-4.3 Washing medium, capable of removing the flux residue after soldering.

F-4.4 Copper sheet of thickness of $50 \text{ mm} \times 50 \text{ mm} \times 0.50 \text{ mm}$, of Cu-DHP (phosphorus deoxidized) grade of IS 14811 or any other equivalent international/industry specification.

F-5 APPARATUSES AND INSTRUMENTS

The apparatuses and instruments to be used shall be as follows.

F-5.1 Solder bath, containing not less than 4 kg of molten solder. The liquid solder in the bath shall be at least 25 mm in depth, with a surface area easily capable of accommodating the test specimen. As a minimum, the bath temperature shall be capable of being maintained at a set temperature of the liquidus temperature of the alloy in the test plus 35°C . The test temperature shall be documented.

F-5.2 Drying oven, capable of setting and maintaining at a temperature of $150\text{ }^{\circ}\text{C} \pm 3\text{ }^{\circ}\text{C}$.

F-5.3 Tongs or other suitable mechanical device, suitable for horizontally lowering the copper sheet, in a horizontal plane, onto the surface of the liquid solder in the bath and raising it again, also in a horizontal plane.

F-5.4 Scrubber, capable of easily removing the oxidized film of solder in the solder bath.

F-5.5 Spatula

F-5.7 Micrometer, capable of measuring at least 0.001 mm.

F-5.8 Observation device such as planimeter or a microscope, suitable for measuring surface areas of the order of 100 mm^2 .

F-5.9 Glass apparatuses or equivalent apparatuses.

F-5.10 Abrasive paper, P600 (waterproof) specified in IS 15287 (Part 3).

F-5.11 Chemical balance or electronic force balance, having a sensitivity of 0.000 1 g or 0.001 g.

F-6 TEST PROCEDURE

The test procedure shall be as follows.

F-6.1 Preconditioning of Copper Plate

Preconditioning of copper plate shall be as follows.

Clean the surface of the copper plate with ethanol. Polish one side of copper plate with an abrasive paper while dropping ethanol onto it, then wash with ethanol and dry thoroughly at room temperature. Put this plate in a drying oven set at $150\text{ }^{\circ}\text{C} \pm 3\text{ }^{\circ}\text{C}$ for 1 h for oxidization, and use as an oxidized copper plate.

F-6.2 Test Operation

The test operation shall be as follows.

Wash the surface of the sample with acetone, rinse with distilled or deionized water, wash with 2-Propanol, and dry to use in tests weigh out $0.30\text{ g} \pm 0.03\text{ g}$ of the sample, swirl it, place on the centre of copper plate, and take as the test specimen. Prepare five test specimens. Heat the test specimen by floating on a solder bath at a temperature $35\text{ }^{\circ}\text{C} \pm 3\text{ }^{\circ}\text{C}$ higher than the liquidus temperature of the solder. Immediately before floating the test specimens on the solder bath, use a scrubber to remove the oxidized film of solder on the surface of the solder bath. Maintain the temperature for 30 s after the test specimen is floated and the sample is fused. Then, horizontally lift the test specimen from the bath, and cool it to room temperature. Remove the flux residue by a suitable medium.

F-7 EVALUATION

F-7.1 Calculation of Spreadability

Measure the height of the fused and spread solder by a micrometer or any other proper instrument. Using the measured value, calculate and calculate the ratio of spread, expressed as a percentage, by the formula. Using the measured value, calculate the spreadability (in percentage) according to formula below. Repeat this operation for five test specimens, obtain the mean to the first decimal place, and take it as the spreadability of the sample.

$$S_R = \frac{D - H}{D} \times 100$$

where

S_R , is the spreadability (percent);

H, is the height of spread solder (mm);

D, is the diameter of the solder, when it is assumed to be a sphere (mm), $D = 1.24V^{1/3}$; and

V, is the volume of solder used in the test or the volume obtained by dividing the mass of sample by the density (mass/density) (mm^3). In the cases of flux cored solder and solder paste, the mass of solder used for the test shall be the mass of the sample minus the mass of flux contained.

F-7.2 Calculation of Spread Area

Measure the area of fused and spread solder on each of five test specimens of by a planimeter and microscope or any other suitable device etc. Obtain the mean to the first decimal place, and take it as the spread area (mm^2) of the sample.

ANNEX G

(Foreword, Clause 7.5 and Annex B)

FLUX RESIDUES TEST — EVALUATION OF TACKINESS OF FLUX RESIDUE**G-1 OBJECTIVE OF THE TEST METHOD**

This test is a qualitative method for the evaluation of the tackiness of the flux residues of rosin type (RO), resin type, (RE) and organic type (OR) (water-insoluble organic and water-soluble flux) specified in Table 6 after a soldering process. The method is applicable only to fluxes of types L and M as shown in Table 7 of Annex D. The method is particularly appropriate for applications where flux residues are left *in situ* on soldered electronic and electrical equipment.

G-2 PRINCIPLE

The flux is melted on a copper sheet test piece in contact with a standard mass of solder. In the case of flux cored solders and solder pastes, a standard mass of the material is melted on the copper test piece. After the test piece has cooled to room temperature, the flux residues are evaluated for tackiness by degree of adhesion of powder chalk to them.

G-3 TEST SPECIMEN

A minimum of 0.035 to 0.040 grams by weight is required per test for fluxes in solid or paste form. For liquid fluxes, a volume sufficient to contain a minimum of 0.035 grams of non-volatile matter is required per test. For samples of flux cored solder, a minimum 1 gram is required per test and for solder paste, a minimum of 0.5 grams is required per test.

G-4 REAGENT AND MATERIALS

The reagents and materials to be used shall be as follows:

- a) In the test use only reagents of recognized analytical quality and only distilled, or deionized water; and
- b) Acid cleaning solution — Add cautiously, while stirring, 75 ml of sulphuric acid (density 1.84 g/ml) to 210 ml of water and mix. Cool, add 15 ml of nitric acid (density 1.42 g/ml) and mix the solution thoroughly;
- c) Degreasing solvent, such as propan-2-ol, acetone, toluene, petroleum ether etc;
- d) Powdered chalk or powder talc;
- e) Copper sheet of thickness of (0.50 ± 0.05) mm, of Cu-DHP (phosphorus deoxidized) grade of IS 14811 or any other equivalent international/industry specification;
- f) Acetone; and
- g) The solder used for the test and the test temperature shall be selected from one of the following:
 - i) Sn60Pb40, according to ISO 9453, at (235 ± 3) °C;
 - ii) Sn96Ag3Cu0,5, according to ISO 9453, at (255 ± 3) °C;
 - iii) any other solder or temperature combinations as agreed between the customer and the flux supplier. For test temperatures, *see G-6.2*.

G-5 APPARATUS AND INSTRUMENTS

The apparatus and instruments to be used shall be as follows:

- a) Solder bath, either circular with diameter not less than 120 mm, or rectangular with dimensions not less than 100 mm × 75 mm, containing tin-lead solder having a liquidus temperature less than 200 °C. The depth of the solder in the bath shall not be less than 40 mm. As a minimum, the bath temperature shall be capable of being maintained at a set temperature of the liquidus temperature of the alloy on the test plus 35 °C;
- b) Cupping device: This shall be fitted with a 27 mm diameter die and a 20 mm diameter steel ball;
- c) Tongs, or other suitable mechanical device, to lift the test piece from the surface of the molten solder bath;
- d) Soft brush, of diameter approximately 7 mm; and
- e) Ordinary laboratory apparatus.
- f) Drying oven, suitable for use at (60 ± 2) °C and (110 ± 2) °C

G-6 TEST PROCEDURE, EXAMINATION AND EVALUATION

G-6.1 Preparation of Copper Test Piece

- a) From the sheet of half hard copper, approximately 0.5 mm thick [see G-4 e)], cut test pieces, each measuring 50 mm × 50 mm;
- b) Clamp each of the test pieces, in turn, centrally onto the 27 mm die of the cupping device [see G-5 b)]. Using the 20 mm diameter ball, make a depression in the centre of each test piece 3 mm deep, by forcing the ball into the die. One corner of the test piece may be bent up to facilitate handling with the tongs;
- c) Immediately before the test, use the solvent [see G-4 c)], to degrease each test piece, and immerse the test pieces for 20 s in the acid cleaning solution [see G-4 b)]. Remove the test pieces from the cleaning solution, wash well under running water, rinse in acetone [see G-4 f)], and dry by air blowing at room temperature; and
- d) Now, for solid, paste and liquid flux samples follow the procedure given below else follow the procedure given in G-6.1 e) or f) for cored solder or solder paste respectively.
 - Weigh $1.00 \text{ g} \pm 0.05 \text{ g}$ of the solder wire or pellets [see G-4 g)], previously degreased in the solvent [see G-4 c)], and transfer it to the centre of the depression in one of the cleaned copper test pieces [see G-6.1 a) to c)].
 - NOTE — This may conveniently be done, if solder wire is used, by forming the wire into a tight spiral.
 - According to the form of the flux under test, continue with the preparation of the test piece by following the procedure given in either i) or ii) as follows:
 - i) if the flux under test is in solid or paste form, weigh between 0.035 g and 0.040 g of the solid or paste flux and add this to the solder in the depression of the test piece;
 - ii) if the flux under test is in liquid form, first determine its non-volatile matter content by the use of the method described in Annex L. Then add the appropriate volume of the liquid flux, containing between 0.035 g and 0.040 g of non-volatile matter, to the solder in the depression of the test piece. Evaporate the solvent at 60 °C for 10 min in the drying oven [see G-5 f)].
 - NOTE — If the liquid flux has low non-volatile content, it may be necessary to add the flux in two increments, carrying out the evaporation procedure after each addition.
- e) For flux cored solder samples, degrease the surface of a suitable length of the cored solder sample, using a cloth dampened with the degreasing solvent [see G-4 c)]. Weigh (1.00 ± 0.05) g of the

degreased sample, form it into a small flat coil and place it in the centre of the depression in one of the cleaned copper test pieces.

- f) For solder paste samples. Weigh 0.50 ± 0.05 g of the solder paste sample into the center of the depression in one of the cleaned copper test pieces [see G-6.1 a) to c)].

G-6.2 Heating the Test Piece

- a) Using the tongs [see G-5 d)], or other suitable means, carefully lower the prepared test piece onto the surface of the molten solder, maintained at the test temperature in the solder bath [see G-5 a)], The solder liquidus temperatures given in IS 193 should be used as a reference. The test temperature depends on the type of solder used for the test; therefore, the test temperature shall be selected from one of the following:
- i) Sn60Pb40, according to IS 193, at (235 ± 3) °C;
 - ii) Sn96Ag3Cu0.5, according to IS 193, at (255 ± 3) °C;
 - iii) any other solder as agreed between the customer and the flux supplier at (35 ± 3) °C higher than the liquidus temperature of the any other solder alloy
- b) Allow the test piece to float on the solder bath until the solder melts and leave the test piece in this position for a further 5 s. Remove the test piece carefully from the bath and allow it to cool, in air, in a horizontal position for 30 min.

G-6.3 Examination of the Test Piece

Dust the surface of the flux residue on the test piece liberally with the powdered chalk [see G-4 d)]. Lightly brush the chalked surface with the soft brush [see G-5 e)].

G-6.4 Evaluation

If the chalk powder is easily removed by brushing, the flux is deemed to be 'not tacky'. If the chalk powder cannot be removed by brushing, or can be removed only with difficulty, the flux is deemed to be "tacky."

ANNEX H

(Foreword, Clauses 7.1.1.2, 8.2 and 8.3)

MEASUREMENT OF NOMINAL DIAMETER

H-1. Cut back approximately 2 m from the free end of the wire and then cut a test specimen, approximately 2 m in length for determination of flux content and wire diameter.

H-2. Using the 2 m long sample of wire selected in accordance with **H-1**, measure with a micrometre or by measuring instruments equivalent or superior thereto in precision, to the nearest 0.01 mm, the minimum and maximum diameters at positions 20 mm from one end of the sample. Calculate the average of two micrometer readings to obtain mean diameter. Repeat the procedure at 20 cm intervals along the sample and calculate the mean diameter at each location. Ignore the final location if it is less than 20 cm from the end of the sample.

ANNEX J

(Foreword, Annex B, Annex C and Clause D-4.1.1)

FLUX INDUCED CORROSION (COPPER MIRROR METHOD)**J-1 OBJECTIVE OF TEST METHOD**

This test method is designed to determine the removal effect the flux has (if any) on the bright copper mirror film which has been vacuum deposited on clear glass.

J-2 PRINCIPLE

For flux samples in the form of a solid or paste, and for flux-cored solder, a flux test solution containing 25 percent (m/m) of solids is prepared. For liquid flux samples, the liquid is used full strength as the flux test solution. The flux test solution is then evaluated in terms of its attack on a copper film previously vacuum deposited onto a glass plate (copper mirror). A rosin reference solution, which should not cause removal of the copper film, is used as a control. The object of the test is to determine the flux reactivity due to the presence of free halide activators.

NOTE — The presence of amines in the flux can cause misleading results in that the flux appears to pass the test, when in fact it has a highly reactive composition

J-3 REAGENTS AND MATERIALS

Use only reagents of recognized analytical grade and only distilled, or deionized, water.

- a) Reagent grade (99 percent pure) 2-propanol;
- b) Control standard rosin flux, grade WW of IS 553;
- c) Degreasing agent, such as a suitable neutral organic solvent such as acetone, ethanol, methanol or petroleum ether etc; and
- d) 500 ml of reagent grade 0.5percent solution of EDTA (Ethylene Diamine Tetra Acetic acid).

J-4 APPARATUS AND INSTRUMENTS

Usual laboratory apparatus and, in particular, the following.

- a) Temperature/Humidity oven, capable of achieving and maintaining the temperature and relative humidity at (25 ± 2) °C and (50 ± 5) percent, respectively;
- b) A relative humidity gauge having a ± 2 percent accuracy or better shall be used to continuously monitor the test environment. The gauge should be calibrated periodically;
- c) A vacuum deposition system or the means to procure glass test panels having a copper mirror coating as described in point c) of **J-6.1.3.2**;
- d) Glass slides; and
- e) Glass dropper or micro syringe or micropipette capable of measuring 0.05 ml.

J-5 TEST SPECIMEN

A minimum 10 ml of extracted flux solution of (25 ± 2) percent by mass, extracted in accordance with Annex A.

J-6 TEST PROCEDURE

J-6.1 Preparation

J-6.1.1 *Preparation of standard rosin solution/rosin reference solution – 25 percent (m/m)*

A 25 percent m/m) rosin reference solution is prepared by dissolving 25 g of WW grade colophony in 75 g of propan-2-ol.

J-6.1.2 *Preparation of Temperature/Humidity Chamber*

When acid or salt solutions are used, the environment shall be monitored for a minimum of 48 h prior to exposing the copper mirror test panels, to assure compliance with the (50 ± 5) percent relative humidity requirement.

J-6.1.3 *Preparation of Copper Mirror Test Panels.*

J-6.1.3.1 Thoroughly clean glass slide plates, approximately 25 mm × 50 mm or bigger (for example 50 mm × 75 mm) in size with acetone or any other degreasing agent such as petroleum ether and dry them.

J-6.1.3.2 Apply by vacuum deposition, a film of copper metal on one surface of a flat glass sheet or clear, polished glass. Apply a uniform thickness of approximately 50 nm and assure that the finished mirror permits (10 ± 5) percent transmission of normal incident light of nominal wavelength of 500 nm. This may be determined using a suitable photoelectric spectrophotometer. Commercially available copper mirrors meeting the above specifications are acceptable. Prevent oxidation of the copper mirror by storing in a closed container which has been flushed with nitrogen until use.

J-6.1.3.3 Immediately before testing, check the presence of oxide on the copper mirror test specimen. If oxide is found, immerse the copper mirror in a 5 g/l solution of EDTA for one minute for copper oxide removal. Mirrors stored in a non-oxidizing environment, do not require cleaning with the EDTA solution prior to testing. The cleaning step shall be used if test results are in dispute.

J-6.1.3.4 After cleaning step, rinse the mirror thoroughly in running distilled/deionized water, immerse in clean degreasing solvent such as acetone or ethanol or methanol and dry with clean, oil free air.

J-6.1.3.5 Carefully examine the copper mirror before testing. There shall be no oxide.

J-6.2 Test

- a) Place the copper mirror test panel on a flat surface, mirror side up, and protect from dust and dirt at all times. Place one drop of test flux or flux extract to be tested (approximately 0.05 ml) on each copper mirror test panel. Do not allow the dropper to touch the test panel. (It has been determined that significant variations from this quantity have little effect for most materials);
- b) At the same time, place one drop of the control standard flux/rosin reference solution adjacent to the test flux at a distance of approximately 35 mm. Do not allow drops to touch;

- c) Place test panel in a horizontal position in the dust-free cabinet at (25 ± 2) °C and (50 ± 5) percent relative humidity for 24 h;
- d) After 24 h remove the mirror from the oven and wash off the flux residues of test flux and control standard flux using 2-propanol, or using the solvent used in flux extraction procedure. Dry the mirrors using a stream of warm air; and
- e) Examine the copper mirror against a white background.

NOTE — The presence of free halide activators in the flux test solution results in partial or complete removal of the copper film at the location of the drop, the copper mirror becoming progressively more transparent as the flux reactivity increases. The presence of amines in the flux can cause misleading results.

J-6.3 Evaluation

- a) Carefully examine each test panel for possible copper removal or discoloration;
- b) *See* Table 2, Clause **D-4.1.1** and Fig. 2 for evaluation criteria.[If there is any complete removal of the copper film as evidenced by the background showing through the glass, the test flux has failed the L category. Complete removal of the copper only around the perimeter of the drop defines the flux as M. Complete removal of the copper places the flux in the H category (*see* Fig. 2)];
- c) If the control flux fails the L category, repeat the entire test using a new copper mirror test panel.
- d) Discoloration of the copper film due to a superficial reaction or only a partial reduction of the copper film thickness is not considered as failure; and
- e) A number of chemicals can cause failure of copper mirror: free halides, stronger organic and inorganic acids and free amines.

J-6.4 Test Report

The test report shall include at least the following information:

- a) The flux extraction procedure used (*see* Annex A that is whether Method A or Method B);
- b) The results obtained;
- c) Any unusual features noted during the determination;
- d) Details of any operation not included in document, or regarded as optional;
- e) Details of the solvent used in the preparation of the flux test solution if not 2-propanol; and
- f) The date of the test

ANNEX K

(Clauses A-2.1, A-2.2.5, Annex B, Annex C and Clause D-4.1.2)

COPPER PLATE CORROSION TEST**K-1 OBJECTIVE AND PRINCIPLE OF THE TEST METHOD**

K-1.1 This test method is designed to determine the corrosive properties of flux residues under extreme environmental conditions.

K-1.2 A test specimen is prepared using a preconditioned copper plate on which solder is fused in contact with the flux. The test piece is then exposed to a controlled temperature/humidity environment and the resulting corrosion of the copper, if any, is assessed using a low-power microscope.

K-1.3 For the purposes of this test method, the following is the definition of corrosion: 'chemical reaction between the copper, the solder, and the constituents of the flux residues, which occurs after soldering and during exposure to the above environmental conditions.'

K-1.4 Colour photos before and after the test are valuable tools in identifying corrosion.

K-2 TEST SPECIMEN

At least 0.035 g to 0.04 g of flux solids, 0.5 g solder paste, 1 g wire, or 1 g preform with an equivalent amount of solids. Flux solids are the residue or solids content of flux after evaporation of the volatile chemicals from within the flux determined by the method given in Annex L. All solvent shall have been evaporated from the specimen in a chemical fume hood.

K-3 REAGENTS AND MATERIALS

Only reagents of recognized analytical quality and only distilled or deionized water shall be used.

K-3.1 Ammonium Peroxodisulfate Solution

Dissolve 250 g of ammonium peroxodisulfate $[(\text{NH}_4)_2\text{S}_2\text{O}_8]$ in water and add cautiously 5 ml of sulphuric acid (density 1.84 g/ml). Mix, cool, dilute to 1 l and mix. This solution shall be freshly prepared before use.

K-3.2 Sulphuric Acid, 5 Percent (by Volume) Solution

Add cautiously, with stirring, 50 ml of sulphuric acid ($\rho = 1.84$ g/ml) to 400 ml of water and mix. Cool, dilute to 1 litre and mix well.

K-3.3 Neutral organic solvent for degreasing, such as Acetone or Petroleum Ether etc.

K-3.4 Copper sheet, of thickness of (0.50 ± 0.05) mm and of Cu-DHP (phosphorus deoxidized) grade of IS 14811 or any other equivalent international/industry specification.

K-3.5 Solder wire or pellets, complying with IS 193, Sn63Pb37, Sn60Pb40, Sn96.5Ag3Cu0.5 or any other solder alloy as agreed between the user and the supplier.

K-4 APPARATUS

Usual laboratory apparatus and, in particular, the following.

K-4.1 Solder bath, either circular with diameter not less than 120 mm, or rectangular with dimensions not less than 100 mm × 75 mm, filled with solder having liquidus temperature at (35 ± 3) °C higher than the liquidus temperature of the solder used for test. For solder alloys except Sn63Pb37 and Sn60Pb40, the temperature of the solder pot may be approximately 40 °C higher than the liquidus temperature of each alloy.

K-4.2 Humidity chamber, capable of achieving (40 ± 2) °C and relative humidity of 90 percent to 95 percent;

K-4.3 Cupping device (for example an Erichsen cupping machine (*see* IS 10175) or equivalent cupping device).

The device shall be fitted with a 27 mm diameter die and a 20 mm diameter steel ball (*see* Fig. 3).

K-4.4 Drying oven (air circulating), suitable for use at (60 ± 2) °C.

K-4.5 Low-power stereomicroscope, capable of ×20 magnification, equipped with quartz-halogen illumination.

K-4.6 Tongs or other suitable mechanical device, to lift the test piece from the surface of the molten solder bath.

K-4.7 Analytical balance capable of weighing 0.001 g.

K-5 PREPARATION OF TEST PIECES

From a sheet of copper 0.5 mm thick, cut square test pieces 50 mm × 50 mm each. Clamp each of the test pieces, in turn, centrally onto the 27 mm diameter die of the cupping device. Using the 20 mm diameter steel ball, make a 3 mm deep depression in the center of each test piece by forcing the ball into the die (*see* Fig. 3). One corner of the test piece may be bent up to facilitate handling with the tongs.

Immediately before use, pre-treat the test pieces in accordance with the following sequence of operations a) to h), ensuring that clean tongs are used for handling.

- a) Degrease the test pieces with a suitable neutral organic solvent (*see* **K-3.3**);
- b) Immerse the test pieces in sulphuric acid solution (**K-3.2**) at (65 ± 5) °C for 1 min to remove the tarnish film;
- c) Immerse the test pieces in the ammonium peroxodisulfate solution (**K-3.1**) at 20 °C to 25 °C for 1 min to etch the surface uniformly;
- d) Wash the test pieces under running tap water for a maximum of 5 s;
- e) Immerse the test pieces in sulphuric acid solution (**K-3.2**) at a temperature not greater than 25 °C for 1 min;
- f) Wash the test pieces under running water for about 5 s and rinse in distilled or deionized water. Immerse immediately in the degreasing solvent (**K-3.3**);
- g) Allow the test pieces to dry in clean air; and

- h) Use the test pieces immediately or after a maximum storage period of up to 60 min in a closed container.

Unit: mm

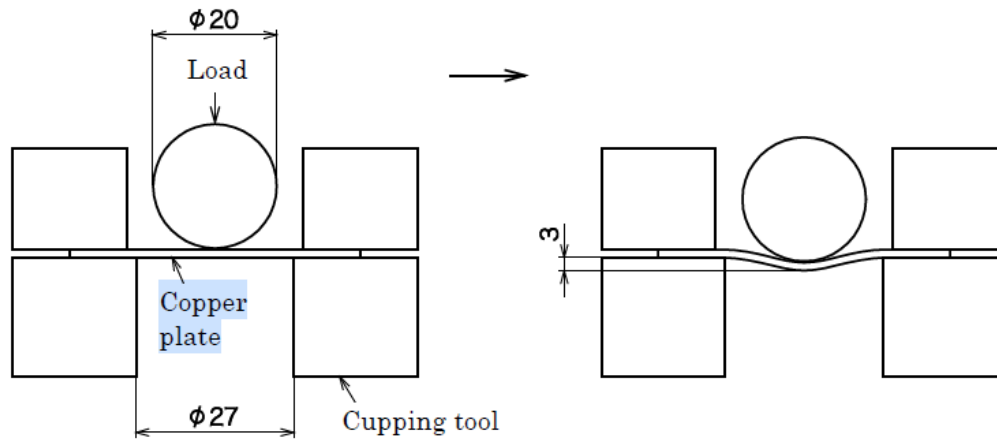

FIG. 2 DIMENSIONS OF PENETRATOR, DIE AND BLANK-HOLDER

K-6 PROCEDURE

K-6.1 General

Select three cleaned copper test pieces (*see K-5*), one of which will serve as the blank. Follow the procedures in **K-6.2** to **K-6.6** on the three test pieces. Omit the procedures in **K-6.4** in the case of the blank.

K-6.2 Fluxing the Test Pieces

K-6.2.1 For flux-cored solder samples

If the flux is present in the form of flux-cored solder, degrease the surface of a suitable length of the cored solder sample, using a cloth dampened with the solvent (**K-3.3**). Weigh (1.00 ± 0.05) g of the degreased sample, form it into a small flat coil and place it in the centre of the depression in one of the test pieces (*see K-6.1*). Repeat for the other two test pieces.

K-6.2.2 For solid, paste and liquid flux samples

Weigh (1.00 ± 0.05) g of the solder wire or pellets (**K-3.5**), previously degreased with a neutral organic solvent (**K-3.3**), and transfer to the centre of the depression in one of the test pieces (*see K-6.1*).

NOTE – This may conveniently be done, if wire is used, by forming the wire into a small flat coil.

Repeat for the other two test pieces (*see K-6.1*).

According to the form of the flux under test, continue with the preparation of the test pieces by following the procedure given in either a) or b) as follows:

- If the flux under test is in solid or paste form, weigh between 0.035 g and 0.040 g of the solid or paste flux and add this to the solder in the depression of the test piece. Repeat for the other two test pieces.
- If the flux under test is in liquid form, first determine its non-volatile matter content by the use of the method described in Annex L, then add the appropriate volume of the liquid flux, to contain between 0.035 g and 0.040 g of non-volatile matter, to the solder in the depression of the test piece.

If the non-volatile matter content of the liquid flux is so low that the volume required would more than fill the depression, then use sufficient flux to just fill the depression. Repeat for the other two test pieces.

Evaporate the solvent at $(60 \pm 2) ^\circ\text{C}$ for 10 min in the drying oven (**K-4.4**).

K-6.2.3 For Solder Paste Samples

If the flux is present in the form of solder paste, weigh (0.5 ± 0.05) g of the solder paste sample and place it into the centre of the depression in one of the test pieces (*see* **K-6.1**). Repeat for the other two test pieces.

K-6.3 Heating the Test Pieces

Using the tongs (**K-4.6**) or other suitable means, carefully lower the fluxed test piece from **K-6.2** onto the surface of the molten solder, maintained at the test temperature in the solder bath (**K-4.1**). Depending on the type of solder used for the test, the test temperature shall be selected from one of the following:

- Sn60Pb40 (*see* IS 193) at $(235 \pm 3) ^\circ\text{C}$;
- Sn96.5Ag3Cu0.5 (*see* IS 193) at $(255 \pm 3) ^\circ\text{C}$;
- Any other solder as agreed between the customer and the flux supplier at $(35 \pm 3) ^\circ\text{C}$ higher than the liquidus temperature of any other solder alloy.

Allow the test piece to remain in contact until the solder melts and leave the test piece in this position for a further 5 ± 1 s. For solder paste, allow the test panels to remain in contact with the bath until the solder specimen in the depression of the test panel melts and maintain this position for 60 ± 5 seconds before removing the test panel from the bath. Cool the test panel to room temperature. Further, alternately for solder paste, the fluxed test piece from **K-6.2** can be processed **through** a reflow soldering process using the temperature profile recommended by the vendor instead of melting in the solder pot.

Maintaining the test piece in a horizontal position, remove it carefully from the heating bath and allow it to cool to room temperature.

Repeat for the other two test pieces.

Examine the specimens using the microscope (**K-4.5**) at 20X magnification and record their surface appearance for subsequent comparison after conditioning (*see* **K-6.4** and **K-6.6.2**).

It is recommended that a photographic record be obtained to facilitate this comparison.

K-6.4 Conditioning the Test Pieces

Retaining one of the specimens from **K-6.3** as a blank, preheat the other two to $40 \pm 2 ^\circ\text{C}$ (*see* NOTE) for 30 ± 2 min.

NOTE — Preheating the test pieces avoids condensation onto the test pieces when they are placed in the chamber, which, if it occurred, would invalidate the test.

Then place them in a vertical position in the humidity chamber (**K-4.2**), preset at a temperature of $(40 \pm 2) ^\circ\text{C}$ and 93 ± 2 percent relative humidity.

Alternately, the specimen may be placed in a temperature humidity chamber and heated to 40 ± 2 °C and held for 30 ± 2 min. The humidity should then be increased to 93 ± 2 percent relative humidity.

Allow the two specimens to remain in the chamber, under these conditions of temperature and humidity, for 72 h (3 days) .

K-6.5 Examination of the Test Pieces

Remove the test pieces from the humidity chamber. Examine for evidence of corrosion, using the microscope (**K-4.5**) at $\times 20$ magnification, and compare with the surface appearance of the pieces before conditioning (*see* **K-6.3**) and with the blank, assessing the corrosion in accordance with **K-6.6**.

K-6.6 Assessment/Evaluation of Corrosion

K-6.6.1 General

For purposes of this test method, the following definition of corrosion shall apply: ‘A chemical reaction between the copper, the solder, and the flux residues that occurs after soldering and during exposure to the extreme environmental conditions given in **K-6.4**.’ In this test, corrosion results from a progressive chemical reaction between the copper, the solder and the constituents in the flux residues. For a corrosive flux, the corrosion occurs after soldering and during exposure to the test conditions given in **K-6.4**.

When corrosion occurs, growths of solid corrosion product resulting from the chemical reaction become visible and the evaluation shall be made on the observation of the following positions:

- a) At the boundaries of the flux residues on the copper;
- b) Through discontinuities or cracks in the residues; and/or
- c) As spots under the residues.

NOTES

- 1 Examples illustrating corrosion of these types are given in **K-9**. Each of the Fig.s shown in **K-9** illustrates a typical used test piece after conditioning, showing the silver/blue solder in the centre of the depression in the test piece and surrounded by the flux residue. Each of these is accompanied by a magnified view of a specific area of the test piece [two magnified views in the case of Fig. 4 e)].
- 2 The Figures shown in **K-9** are provided for guidance only.
 - Fig. 4 a) and Fig. 4 b) illustrate test pieces corresponding to typical results obtained from fluxes which PASS the test. Fig. 4 c) to Fig. 4 e) show increasing degrees of corrosion, and all correspond to fluxes which FAIL the test. The principal features of these Figures are as follows.
 - Fig. 4 a): The flux residue is of a brown to brownish-green translucent appearance. The residue is cracked, but there is no evidence at all of any growth of corrosion product. This flux PASSES the test and is characterized as no corrosion.
 - Fig. 4 b): The flux residue is translucent and in the magnified view, olive-green areas are evident in the flux residue due to dissolved copper salts. There is no evidence at all of any growth of corrosion product. This flux PASSES the test and is characterized as no corrosion.
 - Fig. 4 c): In the magnified area, the small blue spots at the flux/copper boundary are clear evidence of the growth of corrosion product. This flux FAILS the test and is characterized as “minor corrosion”

- Fig. 4 d): A considerable amount of blue corrosion growth in the darker areas of the residue, in both views illustrated, is evidence of severe corrosion. This flux “FAILS” the test and is characterized as major corrosion
- Fig. 4 e): The magnified views reveal extensive blue spots of corrosion product growth under the flux residue and in cracks in the residue. This flux “FAILS” the test and is characterized as major corrosion.

K-6.6.2 *Examination after fluxing and melting*

When the test pieces are examined after melting the solder, but before conditioning in the humidity chamber (*see K-6.3*), and show signs of blue spots as in Fig. 4 c) or Fig. 4 d), the flux shall be deemed to have failed the test, and further testing is unnecessary.

However, any change in the colour of the residue which may be observed at this stage of the test procedure, usually to a green hue, without the growth of solid corrosion products can be ignored.

K-6.6.3 *Examination after Conditioning*

When the test pieces are examined after conditioning in the humidity chamber (*see K-6.4 and K-6.5*) and appear comparable with the typical examples given in Fig. 4 a) and Fig. 4 b), the flux shall be deemed to have passed the test. However, if at this stage the test pieces reveal the evidence of corrosion comparable with the typical examples given in Fig. 4 c), Fig. 4 d) or Fig. 4 e), the flux shall be deemed to have failed the test.

NOTE —During conditioning in the humidity chamber, the flux residue and/or the copper test pieces may change in appearance without exhibiting corrosion. For example, the copper may become tarnished or the flux residue may become opaque. These effects, if they occur, can be ignored.

K-7 EXPRESSION OF RESULTS

The results shall be assessed in accordance with the criteria given in **K-6.5** and **K-6.6** and recorded as following and as given in clause **D-4.1.2**:

- a) No corrosion – No evidence of corrosion is observed. Any initial change of color, which may develop when the test panel is heated during soldering, is disregarded as seen in Fig. 4 a) and b);
- b) Minor corrosion – Any initial change of colour, which may develop when test panel is heated during soldering, is disregarded. Discrete white or coloured spots in the flux residue or a colour change to green-blue without pitting of the copper or formation of excrescences is regarded as minor corrosion Fig. 4 c);
- c) Major corrosion – Any initial change of colour, which may develop when test panel is heated during soldering, is disregarded. Subsequent development of green-blue discolouration with observations of pitting on the copper panel or excrescences at the interfaces of the flux residue and copper boundary, is regarded as major corrosion Fig. 4 d) and e); and

NOTE — Questionable results may be confirmed by analyzing the suspected corrosion via Energy Dispersive X-ray Spectroscopy (EDS) for the presence of copper.

K-8 TEST REPORT

The test report shall include at least the following information:

- a) Results obtained that is whether no corrosion , mild corrosion; or severe/major corrosion
- b) Any unusual features noted during the test;
- c) Details of any operation not included in this document, or regarded as optional; and

d) The date of test.

K-9 ADDITIONAL INFORMATION (PHOTOGRAPHIC IMAGES) ON VARIOUS DEGREES OF CORROSION ARISING FROM COPPER CORROSION TEST

The examples given below in the Fig.s illustrate varying degrees of corrosion (no corrosion/minor corrosion/major corrosion) of a typical used test piece after conditioning, showing the silver/blue solder in the centre of the depression in the test piece and surrounded by the flux residue. Each of these is accompanied by a magnified view of a specific area of the test piece [two magnified views in the case of Fig. 4 e)].

The Fig.s shown below are for guidance only.

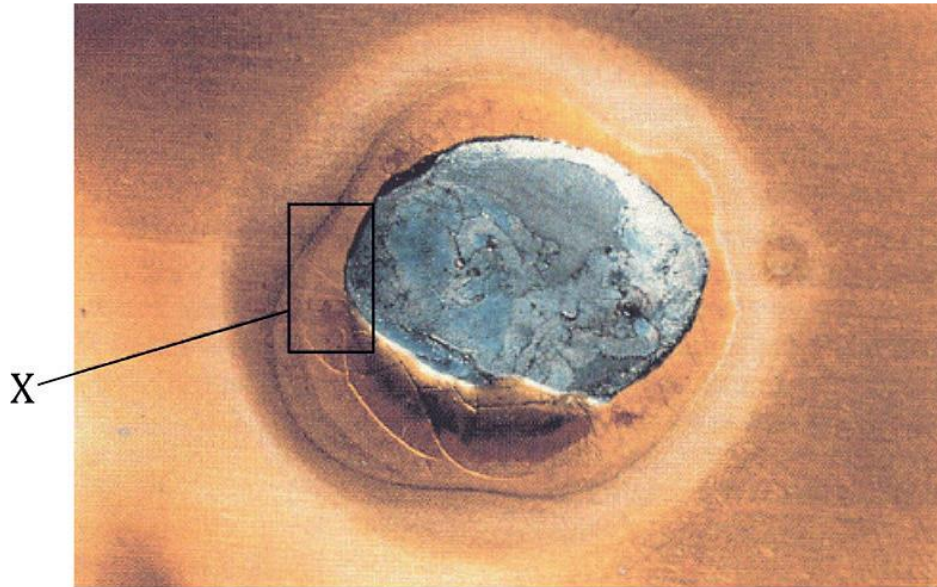

X



a) Brownish-green flux residue but no evidence of corrosion growth: No Corrosion

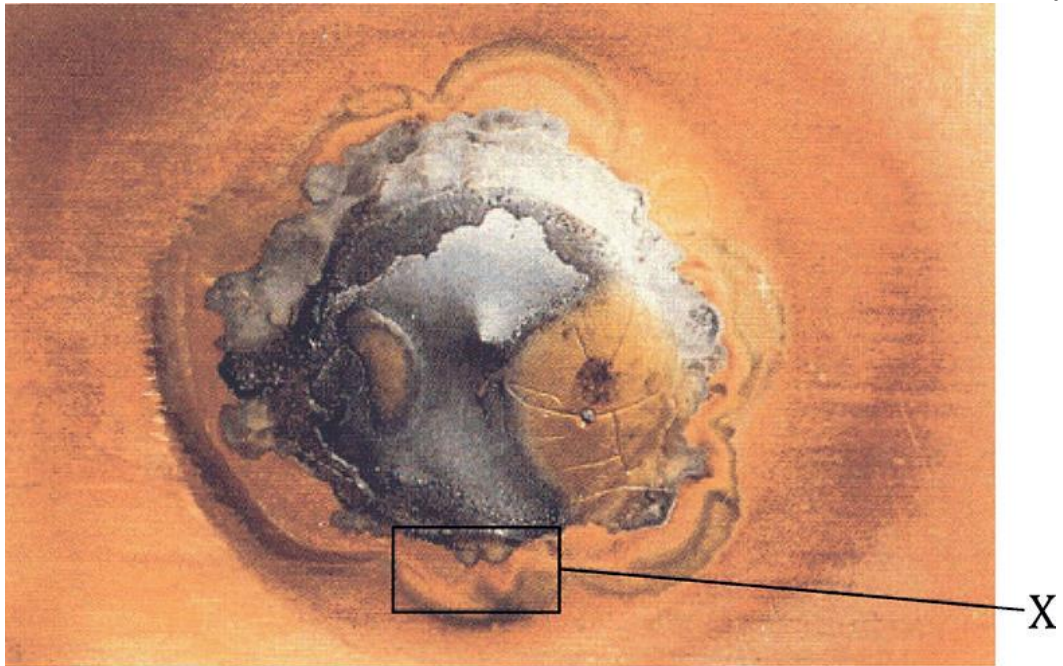

X



b) Olive-green flux residue due to copper salts, but no evidence of corrosion growth: No Corrosion

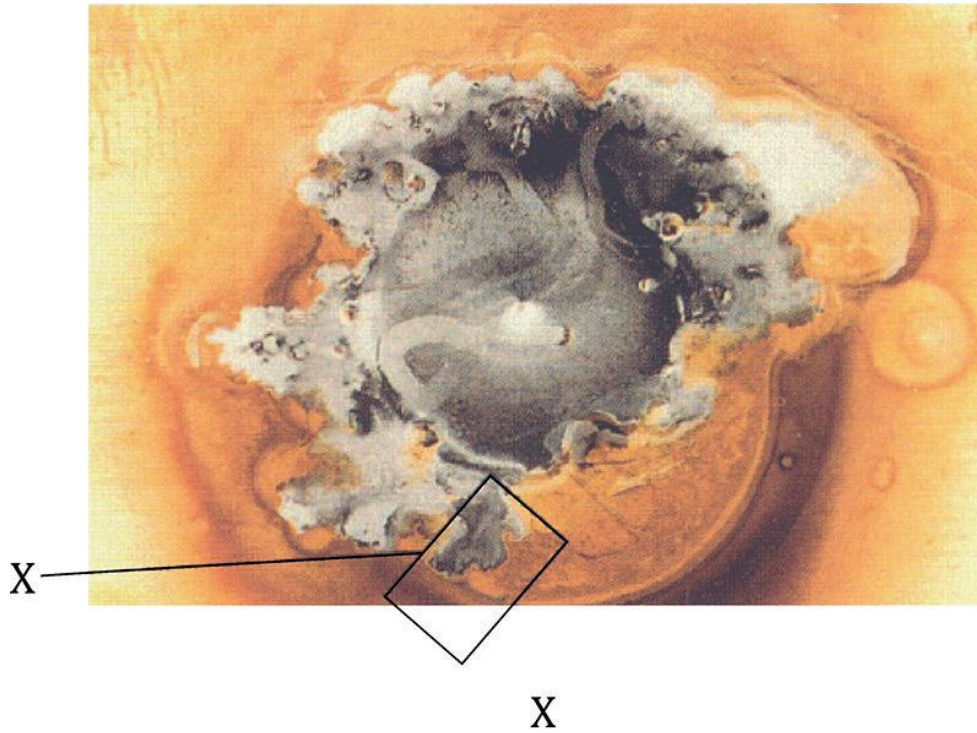

c) Corrosion product growth (blue spots) at the flux/copper boundary: Minor Corrosion

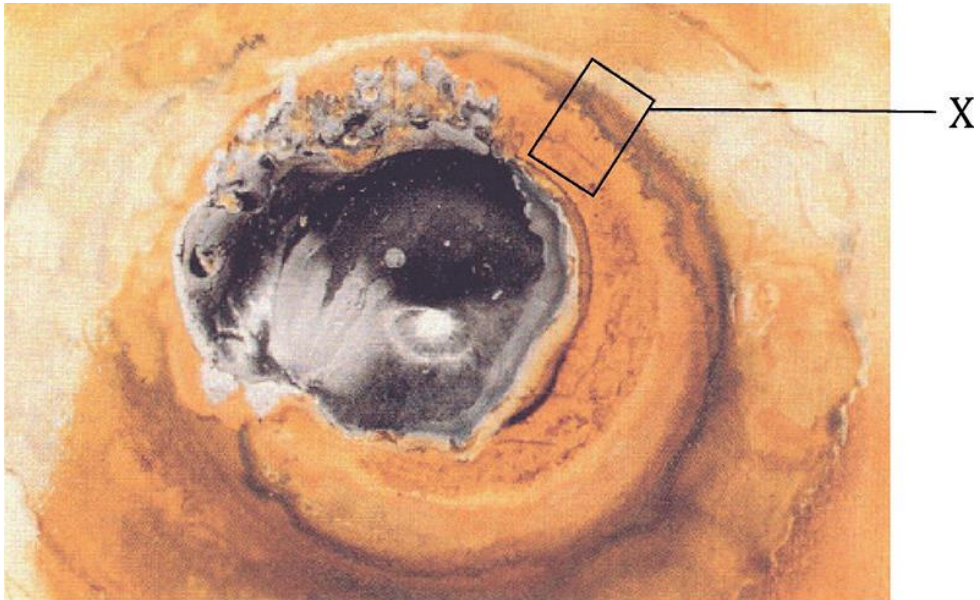

X

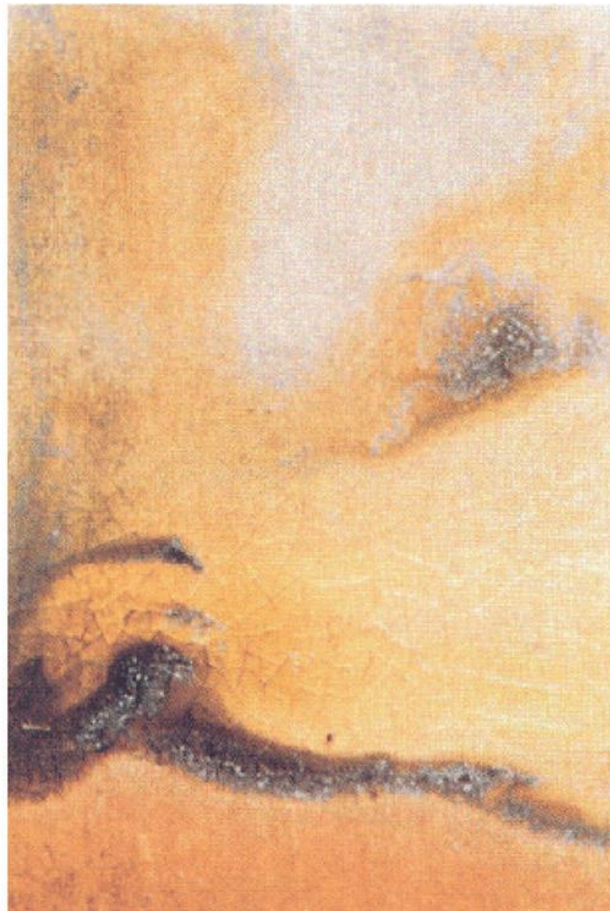

d) Severe corrosion in darker areas of the residue: Major Corrosion

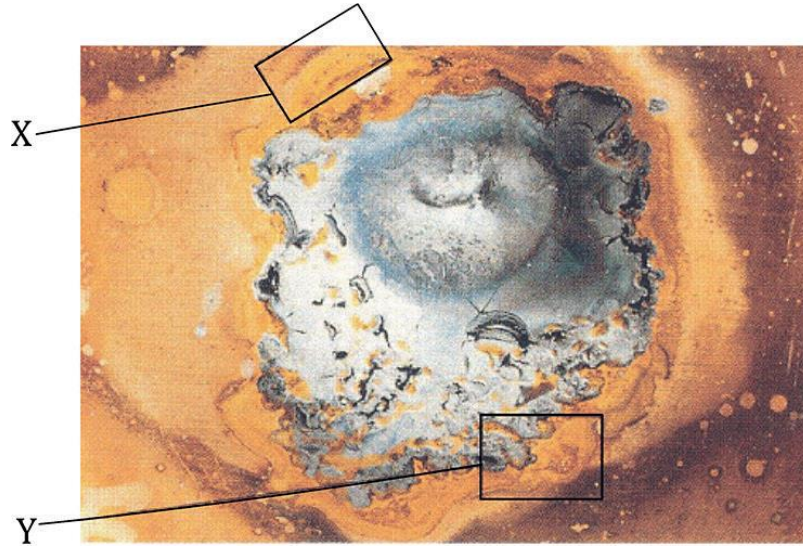

X

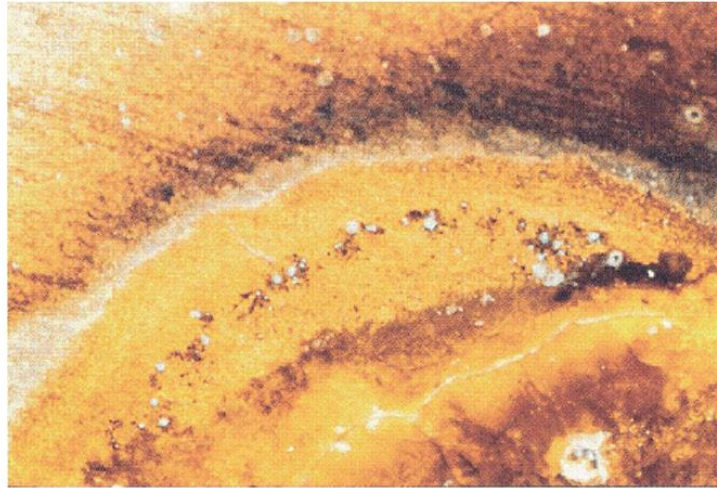

Y



e) Extensive corrosion under the residue and in cracks in the residue: Major Corrosion

FIG. 3 EXAMPLES OF VARYING DEGREES OF CORROSION RESULTING FROM THE COPPER CORROSION TEST

ANNEX L

(Foreword, Annex B, Annex C, Clauses D-4.1.3.2, G-6.1, K-2, K-6.2.2, M-1.2.1, T-3.5 and T-4.4)

FLUX SOLIDS CONTENT/NON-VOLATILE MATTER CONTENT TEST**L-1 OBJECTIVE OF THE TEST METHOD**

This test method is designed to determine the residual solids content/non-volatile matter of the liquid flux and paste fluxes after evaporation of the volatile chemicals; typically 15 percent by weight minimum.

L-2 PRINCIPLE

Extracted flux whose mass has been weighed is heated in a drying oven. After cooling, its mass is reweighed to determine the solid content.

L-3 TEST SPECIMEN

The test specimen shall consist of a minimum of 6 g by weight per test, of extracted flux from flux cored wire in accordance with any of the methods given in Annex A.

L-4 APPARATUSES AND REAGENTS

- a) A circulating air drying oven capable of maintaining 50 ± 5 to 85 ± 5 °C;
- b) Analytical balance capable of weighing 0.001 g;
- c) Glass pipettes;
- d) Glass petri dishes, 30 ml capacity; and
- e) Silica gel desiccant, or equivalent, in a glass desiccator.

L-5 PROCEDURES

Carry out the following procedures in triplicate.

L-5.1 PREPARATION

- a) Dry three empty glass petri dishes in the drying oven for 30 to 60 minutes or until dry, then cool in the desiccator to room temperature; and
- b) Weigh each dish to the nearest 0.001 g.

L-5.2 Test

- a) Pipette approximately 6 g of test flux specimen into each petri dish and weigh to the nearest 0.001 g;
- b) Heat in the drying oven maintained between 50 ± 5 °C and 85 ± 5 °C for $1_{-0}^{+0.25}$ hour, then reweigh after allowing the sample to come to room temperature in the desiccator; and
- c) Repeat heating and drying procedure until the mass is decreased by less than 0.005 g from the previous weighing.

L-6 EVALUATION

Calculate the solids content (mass percent) of the flux portion of the flux cored solder wire as follows:

$$S = \frac{100 \times m_2}{m_1}$$

where

S is the residual solids percentage;

m_2 is the mass of residual after drying, in g; and

m_1 is the mass of original test flux specimen, in g.

L-7 REPORTING

Report the average of the three determinations as the percentage solids.

L-8 ADDITIONAL INFORMATION

L-8.1 Large sample sizes of approximately 18 grams may be required to obtain accurate data on low solids (< 15percent S) fluxes.

ANNEX M

(Foreword, Annex B, Annex C, Clauses D-2.2.2, D-4.1.3.2.1 and D-4.1.3.2.2)

HALIDE CONTENT TEST**M-1 QUANTITATIVE DETERMINATION OF HALIDE CONTENT IN FLUXES (CHLORIDE AND BROMIDE)****M-1.1 Objective of the Test Method**

This test method is designed to determine the halide content of fluxes attributable to chlorides and bromides. The halide content is reported as the weight percentage of chloride to the solid (non-volatile) portion of the flux or as milliequivalent per gram of flux solids.

Method A is an alternative, visual end-point, titration method.

Method A is a potentiometric titration method, which is considered as the referee method.

M-1.2 Visual titration (Method A)**M-1.2.1 Test specimen**

A minimum of 10 ml to 50 ml flux extract (25 percent by mass solution or as agreed but solid content shall be known) from flux-cored wire extracted in accordance with Annex A (Method A being the recommended procedure for obtaining the test solution for halide content testing). The solids content of the sample must be known or determined by Annex L. Alternatively, the flux from the supplier can also be used to prepare the solution.

M-1.2.2 Apparatus and Reagent

Use only reagents of recognized analytical quality and only distilled or deionized water with conductivity less than 10 $\mu\text{S}/\text{cm}$ are to be used. The term 'M' represents molarity of a solution and is calculated by taking the moles of solute and dividing by the litres of solution, e.g. 1.00 mole of sucrose (about 342.3 g) mixed into a litre of water equals 1.00 M (1.00 mol/l).

- a) Ordinary laboratory apparatus.
- b) Hot plate with magnetic stirrer;
- c) Analytical balance capable of reading to 0.001 g;
- d) Pipettes;
- e) Burettes;
- f) 100 ml beakers – Pyrex or heat resistant Borosilicate glass;
- g) 125 ml separatory funnel;
- h) 125 ml Erlenmeyer flasks;
- j) 1 000 ml volumetric flasks;
- k) 0.1 N silver nitrate, standardized: dissolve 17,000 g silver nitrate in deionized water and dilute to 1 000 ml in a volumetric flask;

- m) 1 M (1 mol/l) sodium hydroxide: 40.0 g of sodium hydroxide diluted to 1 000 ml with deionized water in a volumetric flask;
- n) 0.2 M (0.2 mol/l) nitric acid: add 12.6 ml concentrated (16 M) nitric acid to deionized water and dilute to 1 000 ml in a volumetric flask;
- p) 1 M (1 mol/l) potassium chromate: 194 g diluted to 1 000 ml using deionized water in a volumetric flask;
- q) 0.03 M (0.03 mol/l) phenolphthalein solution (reagent grade);
- r) Chloroform (reagent grade);
- s) Deionized water.

M-1.2.3 Procedure

M-1.2.3.1 Rosin/resin fluxes specimen preparation

- a) In a tared 100 ml beaker, accurately weigh about 3 g to 5 g of flux specimen on an analytical balance;
- b) Quantitatively transfer the flux specimen to a 125 ml separatory funnel using three 10 ml aliquots of chloroform;
- c) Add 15 ml of deionized water to the funnel and shake the funnel for 10 s;
- d) Allow the funnel to stand until the layers completely separate;
- e) Draw off the bottom (chloroform) layer into a beaker and save for the next extraction;
- f) Transfer the top (water) layer to a 125 ml Erlenmeyer flask;
- g) Transfer the chloroform layer from the beaker to the funnel and repeat the extraction with 15 ml of water two more times, each time adding the water extract portion to the flask;
- h) Heat the water extract in the Erlenmeyer flask using a steam bath to expel any chloroform which may be present; and
- j) Do not heat above 80 °C. Allow for solution to cool to room temperature.

M-1.2.3.1 For organic and inorganic (water soluble) fluxes

- a) Use an analytical balance to accurately weigh about 3-5 g of flux sample in a tared 125 ml Erlenmeyer flask; and
- b) Add 50ml deionized water.

M-1.2.4 Test

- a) Add two drops of 0.03 M phenolphthalein solution to the Erlenmeyer flask;
- b) Add 1 M sodium hydroxide until the solution turns red. Add 0.2 M nitric acid dropwise until the red colour is just completely discharged;
- c) Dilute to about 60 ml with deionized water; and
- d) Add six drops of 1 M potassium chromate and titrate with standardized 0.1 N silver nitrate to the red-brown end point.

M-1.2.5 Calculations

Calculate the percentage of halides as chloride based on flux solids content, using the following formula:

$$\text{Halides, as percent chlorides} = \frac{3.55 \times V \times N \times 100}{m \times S}$$

Calculate halides milliequivalent per gram of flux solids (non-volatiles) using the following formula:

$$\text{Halides, meq/g solids} = \frac{V \times N \times 100}{m \times S}$$

where

- V is the volume of 0.1 N silver nitrate in ml;
- N is the normality of silver nitrate solution;
- m is the mass of flux specimen in g; and
- S is the percentage of solids (non-volatiles) of the flux.

M-1.3 Potentiometric Titration Method (Method B)

M-1.3.1 Principle

A prepared, weighed sample of the flux is dissolved in a suitable solvent. The resulting solution is titrated with standard silver nitrate solution, using a silver electrode, the mV readings being recorded simultaneously. From the graph of volume of titrant readings against mV readings, the point of inflexion is determined and the percentage halide content, expressed as chloride, is calculated. The method is not suitable for the determination of fluoride.

M-1.3.2 Reagents

Only reagents of recognized analytical grade/quality and only distilled or deionized water with conductivity less than 10 $\mu\text{S}/\text{cm}$ are to be used and in particular the following are to be used:

M-1.3.2.1 Propan-2-ol

M-1.3.2.2 Silver nitrate solution, standardized (0.05 mol/l)

A commercially available 0.05 mol/L silver nitrate solution (N/20 silver nitrate solution) for volumetric analysis, the solution prepared by diluting silver nitrate solution (of the concentration higher than 0.05 mol/L) for volumetric analysis with distilled or deionized water, or the solution prepared by weighing out 8.494 g of silver nitrate of 99.9 percent or above purity specified in IS 2214 into a 1 000 ml volumetric flask and adding distilled or deionized water up to the mark to mix. Store in a coloured bottle. The silver nitrate (AgNO_3) should be dried at $(110 \pm 5)^\circ\text{C}$ for 16 h and cooled in a desiccator before weighing.

When a commercially available standard solution is used, the strength described on the label of standard solution shall apply. If not described, the strength shall be determined by the following method.

Approximately 10 g of sodium chloride (99.95 percent purity, *min*), is dried in the oven for a minimum of 6 h at $(100 \pm 5)^\circ\text{C}$ and allowed to cool to room temperature in the desiccator

Weigh out 2.922 g of the dried sodium chloride dried to the nearest 0.001 g and transfer into a 1 000 ml volumetric flask and dilute up to the mark with distilled or deionized water to mix. Transfer 20 ml of this diluted solution using a volumetric pipette to a 300 ml beaker, add distilled or deionized water to make 200 ml, and titrate with 0.05 mol/L silver nitrate solution according to the procedure of **M-1.3.4.1**. Calculate the strength according to Formula below and round it to the fourth decimal place.

$$f_{\text{AgNO}_3} = \frac{20 \times m \times \frac{A}{100}}{2.922 \times (V - V_b)}$$

where

f_{AgNO_3} : The strength of 0.05 mol/L silver nitrate solution;

m : The mass of sampled sodium chloride (g);

A : The purity of sampled sodium chloride [percent (mass fraction)];

V : The titre of 0.05 mol/L silver nitrate solution (ml);

V_b : The titre of 0.05 mol/L silver nitrate solution in blank test (ml); and

58.44: The mass corresponding to 1 mol sodium chloride (g).

M-1.3.3 Apparatuses and Instruments

The usual laboratory apparatus and, in particular, the following shall be used.

M-1.3.3.1 Potentiometric titrator, millivolt meter, pH meter, automatic potentiometric titrator, etc.

M-1.3.3.2 Electrodes, a platinum electrode or a silver electrode as an indicator electrode and a silver-silver chloride electrode (no halides in internal liquid) as a reference electrode, or the composite electrode that is the combination of the indicator electrode and the reference electrode.

M-1.3.3.3 Magnetic stirrer, having variable speed drive.

M-1.3.3.4 Drying oven, capable of setting and maintaining at a temperature of $100\text{ }^\circ\text{C} \pm 5\text{ }^\circ\text{C}$.

M-1.3.3.5 Chemical balance or electronic force balance having accuracy of 0.0001 g.

M-1.3.3.6 Volumetric pipette and volumetric flask.

M-1.3.4 Test Procedure

The test procedure shall be as follows.

M-1.3.4.1 Resin/Rosin flux cored solder (flux not available)

Wash the surface of the sample with acetone, rinse with distilled or deionized water, wash with 2-Propanol, and dry to use in tests. Weigh out the solder whose amount corresponds to $5.0\text{ g} \pm 0.1\text{ g}$ of flux for the case of the halide content over 0.1 percent (mass fraction) up to and including 1.0 percent (mass

fraction), and cut into chips of 2 mm to 3mm in length. Weigh the total mass of solder chips to the nearest 0.001 g. In the case of halide content other than above, Table 8 should be referred to.

Put all the solder chips in a 300 ml beaker. Add to this 50 ml of 2-Propanol, cover with a watch glass, and shake to mix at room temperature for about 15 min to elute the flux. After complete elution of flux, pour gently the supernatant liquid of the eluate into a 300 ml beaker. Wash the solder chips with 30 ml of 2-Propanol three or four times, join the washings to the supernatant solution in the 300 ml beaker to make 200 ml, and take this as the test solution.

Dry the solder chips after the extraction of flux for 1 h in a drying oven maintained at $100\text{ }^{\circ}\text{C} \pm 5\text{ }^{\circ}\text{C}$. After cooling, weigh the total mass of these solder chips to the nearest 0.001 g. The difference between the mass of resin flux cored solder first weighed and the mass of solder chips after the extraction of flux shall be taken as the mass of flux.

Place the beaker containing the test solution on a magnetic stirrer, put the electrodes in the beaker, and titrate with 0.05 mol/L silver nitrate solution by adjusting the speed of the stirrer to give vigorous stirring without splashing. Take the point of inflection of the curve as the end-point of the titration. Conduct a blank test, using all reagents, for comparison purposes.

M-1.3.4.2 Resin/Rosin flux cored solder (flux available), solder paste, liquid flux and solid flux:

For halide content of over 0.1 percent (mass fraction) but not exceeding 1.0 percent (mass fraction), weigh $5.0\text{ g} \pm 0.1\text{ g}$ of flux to the nearest 0.001 g. In the case of halide content other than above, Table 8 should be referred to. Put this flux in a 300 ml beaker and add 200 ml of 2-Propanol. Stir at room temperature to dissolve as much flux as possible, and take this as the test solution. Hereafter, perform the same procedure as **M-1.3.4.1** above.

Table 8 Relation between Halide Content and Mass of Sample

Sl No.	Item	Halide content [percent(mass fraction)]			
		0.05 or under	Over 0.05 up to and incl. 0.1	Over 0.1 up to and incl. 1.0	Over 1.0
(1)	(2)	(3)	(4)	(5)	(6)
i)	Mass of sample (g)	10	5	5	1
ii)	Digit required for mass measurement (g)	0.001	0.001	0.001	0.001
iii)	Molar concentration of silver nitrate to be used (mol/L)	0.01	0.01	0.05	0.05

M-1.3.5 Calculation of Halide Content

Determine the halide content as the content [percent(mass fraction)] of chlorine (Cl) converted from the sum of chlorine (Cl) content, bromine (Br) content and iodine (I) content in the flux. Calculate according

to Formula given below, and round the mean of the results obtained on three samples to the second decimal place.

$$H = \frac{3.55 \times M_{\text{AgNO}_3} \times (V - V_b) \times f_{\text{AgNO}_3}}{m_3}$$

where,

H is the halide content in flux [percent (mass fraction)];

V is the titre of 0.05 mol/L silver nitrate solution (ml);

V_b is the titre of 0.05 mol/L silver nitrate solution in blank test (ml);

M_{AgNO_3} is the molar concentration of silver nitrate solution used for titration (mol/L);

f_{AgNO_3} is the strength of 0.05 mol/L silver nitrate solution;

m_3 is the mass of sample (g); and

35.5 is the mass corresponding to 1 mol chloride (g).

M-2 QUANTITATIVE DETERMINATION OF FLUORIDE CONTENT IN FLUXES

M-2.1 Objective of the Test Method

This test method is used to determine the concentration of fluorides in soldering flux. The fluoride content is reported as the weight percentage of fluoride to the non-volatile portion of the flux. Ion specific electrodes are used for the determination.

M-2.2 Test Specimen

100 ml of the extracted material from flux cored solder wire.

M-2.3 Apparatus and Reagents

M-2.3.1 Apparatus

- a) Auto calibrating ion analyser;
- b) Fluoride specific electrode;
- c) Double junction reference electrode;
- d) Magnetic stirrer and stir bars;
- e) 250 ml and 500 ml beakers, glass or polypropylene;
- f) Funnel stand and funnel;
- g) 50 ml graduated cylinders;
- h) 100 ml and 1 000 ml volumetric flasks;
- j) 10 ml and 100 ml pipettes; and
- k) Analytical balance capable of weighing 0.001 g.

M-2.3.2 Reagents

- a) Deionized water with a resistivity of at least 18.0 megohm centimetre;

- b) Sodium fluoride, reagent grade (highly pure, without contamination);
- c) Chloroform, reagent grade;
- d) Fluoride analysis solution; and
- e) Whatman #41 ashless filter paper or equivalent.

M-2.3.3 Procedure

M-2.3.3.1 Specimen preparation of water-soluble flux

Depending on the expected concentration of fluoride, use the following amount of specimen and deionized water as shown in **Table 9**.

Table 9 Mixing Ratio from specimen size to water quantity

(Clause M-2.3.3.1)

SI No.	Fluoride ppm (2)	Specimen ml (3)	Deionized Water ml (4)
i)	0.1 to 1.0	25	50
ii)	1.0 to 10.0	5	50

- a) Take the beaker and add the specimen; record the weight of the flux to 0.001 g;
- b) Add deionized water and mix with stirrer for 10 min; stop mixing and allow to stand for 5 min; and
- c) Pour solution through filter paper in funnel into a clean beaker. Allow specimen to drain completely.

M-2.3.3.2 Specimen preparation of non-water soluble flux

Depending on the expected concentration of fluoride, use the following amount of specimen and chloroform as shown in **Table 10**.

Table 10 Specimen Size to Chloroform Mixture

(Clause M-2.3.3.2)

SI No.	Fluoride ppm (2)	Specimen ml (3)	Chloroform ml (4)
i)	0.1 to 1.0	25	25
ii)	1.0 to 10.0	5	5

- a) Take the beaker and add the specimen; record the weight of the flux to 0.001 g;
- b) Add chloroform and 50 ml deionized water and mix with stirrer for 10 min; stop mixing and allow to stand for 5 min; and

- c) Carefully decant the water solution through filter paper in funnel into a clean beaker. Allow specimen to drain completely.

M-2.3.3.3 *Standard solutions*

- a) 10 ppm fluoride (0.001 percent): This standard can be purchased ready-to-use or a solution can be prepared. Weight 0.022 1 g (dried to 140 °C) reagent grade NaF. Add 500 ml deionized water. Dilute to 1 l in a volumetric flask;
- b) 1 ppm fluoride (0.000 1 percent): This standard can be purchased ready-to-use or a solution can be prepared. Weight 0.002 3 g (dried to 140 °C) reagent grade NaF. Add 500 ml deionized water. Dilute to 1 l in a volumetric flask. Another method is to dilute 100 ml, 10 ppm fluoride standard with 450 ml deionized water and dilute to 1 l in a volumetric flask; and
- c) 0.1 ppm fluoride (0.000 01 percent): This standard is prepared by diluting 100 ml, 1 ppm fluoride standard with 450 ml deionized water and dilute to 1 l in a volumetric flask. Another method is to dilute 10 ml of 10 ppm fluoride standard with 495 ml deionized water and dilute to 1 l in a volumetric flask.

M-2.3.3.4 *Double reference electrode filling solutions*

- a) Inner chamber filling solution (green): Solution saturated with AgCl; and
- b) Outer chamber filling solution: 10 percent KNO₃.

M-2.3.4 *Test*

- a) For accurate results, allow all specimens and standards to reach the same temperature before attempting a measurement. Stir the specimens and standards while a measurement is being made;
- b) Prepare two standards that differ in concentration by a factor of 10. The standards should bracket the expected specimen concentration. Select concentration mode and STD 1 function. Significant digit selection is accomplished by pressing the X10 key the required number of times;
- c) Dilute 50 ml of the two standard solutions, each with 50 ml of deionized water;
- d) While stirring with a magnetic stirrer, immerse electrodes in the more dilute standard solution. Adjust the display using arrows or X10 keys to the correct value. When "Ready" illuminates, press "Enter." The display automatically proceeds to 'STD 2';
- e) Remove and rinse electrodes with deionized water. Immerse electrodes in the more concentrated standard solution. Adjust the display to read the correct value for STD 2. When "Ready" illuminates, press "Enter." The display automatically proceeds to "Sample" function; and
- f) To the specimen prepared per instructions for water soluble flux, add 25 ml total ionic strength adjustment buffer. While stirring, immerse electrodes. When display indicates "Ready," record indicated value.

M-2.3.5 *Calculation*

The indicated value is equal to the parts per million (⁻⁶) fluoride. To obtain weight percentage of fluoride as percentage of the non-volatile content, use the following formula:

$$\text{Fluoride percent of solids} = \frac{I}{(mS)100}$$

where

- I is indicated value in parts per million;
- m is the mass of the flux specimen in g; and
- S is the percentage of solids (non-volatile chemicals) of the flux.

M-2.3.6 *Calibration and Limits*

- a) Re-calibration should be carried out every few hours or as recommended by the equipment manufacturer to compensate for electrode drift;
- b) Reproducibility is typically ± 2 percent obtainable with hourly recalibration. Temperature fluctuation, drift and noise will limit reproducibility; and
- c) Detection limits are 0.02 ppm minimum and no known maximum. A list of possible interfering ions has not yet been determined for this electrode method.

ANNEX N

(Foreword, Annex B, Annex C, Clauses D-2.2.2, D-4.1.3.1.1 and D-4.1.3.1.2)

QUALITATIVE HALIDE CONTENT TEST**N-1 DETERMINATION OF HALIDES IN FLUXES, SILVER CHROMATE METHOD****N-1.1 Objective of the Test Method**

This test method is designed to determine the presence of chlorides and bromides in soldering flux by visual examination after placement of the flux on test paper.

N-1.2 Test Specimen

The test specimen shall consist of a minimum of 10 ml of liquid flux, a representative container of solder paste, paste flux for reflow soldering, extracted solder preform flux or extracted flux-cored wire..

N-1.3 Apparatus and Reagents

- a) Six pieces of silver chromate test paper 51 mm × 51 mm;
- b) 250 ml of reagent grade (highly pure, without contamination) propan-2-ol; and
- c) Six glass microscope slides.

N-1.4 Procedure**N-1.4.1 Preparation**

- a) The silver chromate paper is extremely light sensitive and shall be stored in a closed container away from light until used for testing.
- b) To avoid contamination, the paper shall be handled with forceps and shall never be touched with bare hands.

N-1.4.2 Test for Liquid Flux or Flux Extract Solution

- a) Place one drop of test flux or flux extract (approximately 0.05 ml) on each piece of silver chromate test paper. Allow the droplet to remain on each test paper for a minimum of 15 s;
- b) After the 15 s, immediately immerse each test paper in clean propan-2-ol to remove the residual organic materials; and
- c) Allow each test paper to dry for 10 min, then examine for colour change.

N-1.4.3 Evaluation

Carefully examine each test sheet for possible colour change. A change to off-white or yellow-white indicates the presence of chlorides or bromides (*see* Fig 5).

N-1.4.4 Interferences

- a) A number of chemicals may cause test failures. (Representative examples are, but are not limited to, amines, cyanides, isocyanates, etc.); and
- b) Certain acidic solutions may react with the reagent paper to provide a colour change similar to that obtained with chlorides and bromides. When a colour change is observed, it is advisable to check the acidity of the affected area by means of a pH indicating paper. If pH values of less than 3 are obtained, the presence of chlorides and bromides should be verified by other analytical means.

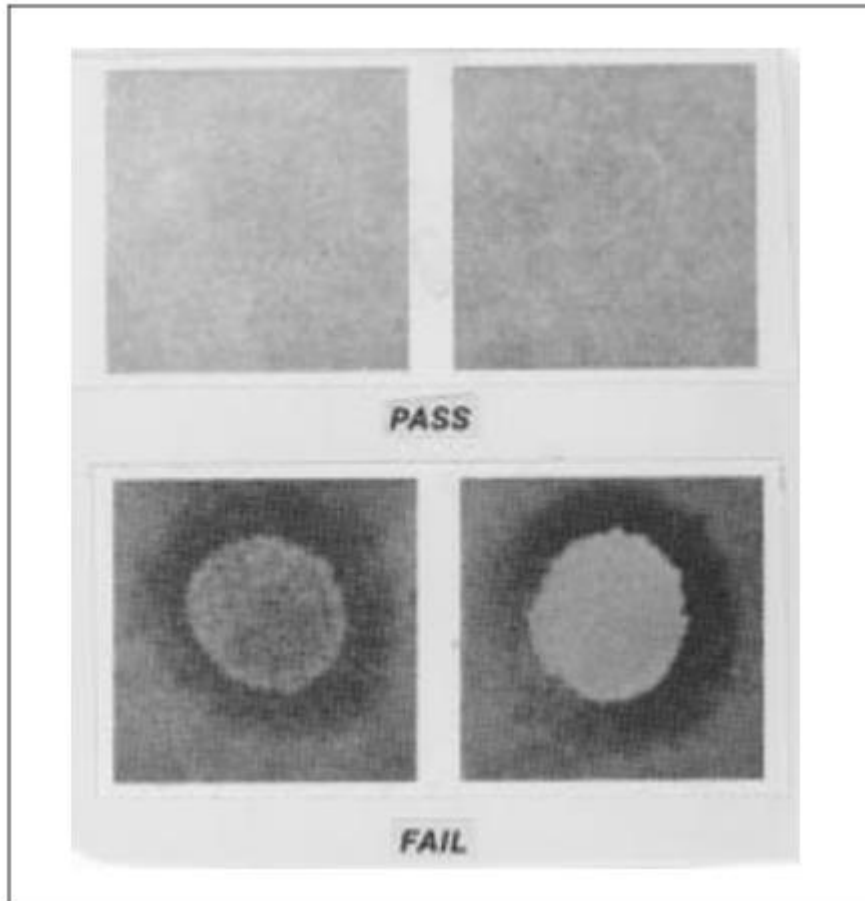

FIG. 4 CHLORIDES AND/OR BROMIDES TEST RESULTS (SOURCE IEC)

N-2 QUALITATIVE ANALYSIS OF FLUORIDES AND FLUXES BY SPOT TEST

N-2.1 Objective of the Test Method

This test method is designed to determine the presence of fluoride(s) in soldering flux by visual examination after placement of a drop of liquid test flux in a zirconium-alizarin purple solution.

N-2.2 Test Specimen

A minimum of 10 ml of a specimen from a production of liquid flux, solder paste flux, paste flux or extracted flux from preform or wire, furnished in a new or clean glass container.

N-2.3 Apparatus and Reagents

N-2.3.1 Apparatus

- a) White spot plate;

- b) Glass droppers; and
- c) Glass rods.

N-2.3.2 Reagents

- a) Zirconium nitrate solution: 0.05 g dissolved in 50 ml of deionized water; and
- b) Sodium alizarin sulfate solution: 0.05 g dissolved in 50 ml of deionized water.

N-2.4 Procedure

N-2.4.1 Preparation

Prepare a fresh zirconium-alizarin purple solution in three spots of the white spot plate by adding one drop each of zirconium nitrate and sodium alizarin sulfate solutions.

N-2.4.2 Test

- a) Add one drop of the test flux to each of the spots;
- b) Mix each spot with a clean glass rod; and
- c) Examine for any colour change.

N-2.4.3 Evaluation

A change in colour of the solution from purple to yellow is an indication of the presence of fluoride(s).

ANNEX P (New 2)

(Foreword, Annex B, Annex C, Clauses D-4.1.4 and D-4.1.5)

SURFACE INSULATION RESISTANCE TEST AND ELECTROCHEMICAL MIGRATION RESISTANCE TEST

P-1 SCOPE

This test method is used to characterize the effects of flux residues on electrical performance by determining the degradation of electrical insulation resistance under conditions of high temperature and humidity. This test method specifies a method of testing for deleterious effects that can arise from flux residues after soldering test coupons.

P-2 OUTLINE OF THE TEST

Comb-patterned printed circuit boards are soldered after the application of flux. The insulation resistance is measured under high temperature and high humidity condition. Coupons are conditioned and measurements taken at a high temperature and humidity. The electrodes are electrically biased during conditioning to facilitate electrochemical reactions, as shown in **Fig. 6** and Fig. 9.

The test employs two different test conditions of 85 °C and 85 % relative humidity (RH), preferred for a process that includes cleaning, or 40 °C and 90 % relative humidity (RH), preferred for processes where no cleaning is involved.

NOTE— 40 °C and 93 percent RH can be used as an alternative to 40 °C and 90 percent relative humidity (RH). Additional information is provided in **P- 7.6.2** and **P-12**.

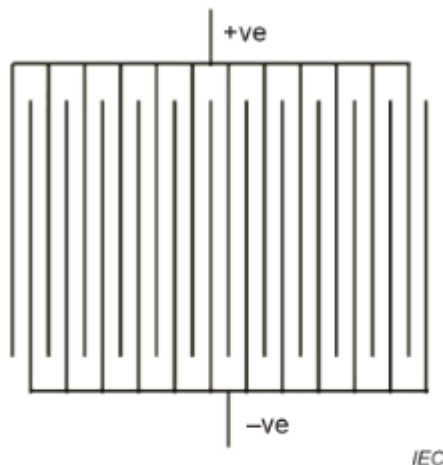

Figure 1 – SIR pattern

Fig. 5 SIR Pattern

P-3 PRINCIPLE

The objective of this test method is to characterize fluxes by determining the degradation of electrical resistance and the electrochemical migration of rigid printed wiring coupon specimens after exposure to

the specified flux. This test is carried out at high humidity and heat conditions under bias voltage. For fluxes, which can leave undesirable residues and hence require cleaning, the results obtained from the test will depend on the characteristics of the flux residue, substrate and metallization, and also on the effectiveness of the cleaning operation.

The measurement of surface insulation resistance (SIR) makes use of a printed wiring coupon substrate having one or more conductive interleaved test patterns. Prior to being subjected to conditioning, the interleaved test patterns are fluxed, soldered or tinned, and cleaned (when required). The patterns are then exposed to a controlled environment for a specified time with an applied voltage. The surface insulation resistance is measured using insulation test apparatus at a suitable test voltage while the test coupons are in the controlled environment. **P-12** provides further information on SIR testing.

P-4 REAGENTS AND MATERIALS

The reagents and materials to be used shall be as follows.

Use only reagents of recognized analytical grade or higher and only distilled or deionized water with a conductivity of less than 0.05 $\mu\text{S}/\text{cm}$ (resistivity $\geq 20 \text{ M}\Omega$).

P-4.1 Propan-2-ol, $(\text{CH}_3)_2\text{CHOH}$ or other suitable solvent.

P-4.2 Cleaning solvent (if required), recommended by the flux manufacturer as suitable for the removal of post-soldering flux residues or propan-2-ol.

P-4.3 Flux Cored Solder for Wiring

Non-activated rosin flux of Annex D, classification ROL0, shall be used in **P-7.5**, tin/lead or lead-free solder shall be agreed between user and supplier conforming to eutectic or near-eutectic tin/lead (S Sn60Pb40E or S Sn63Pb37) or lead-free solder (Sn95.5Ag3Cu0.5) or other lead-free solders as agreed between user and supplier, (*see* IS 193).

NOTE — This wire consists of 60/40 or 63/37 tin/lead solder wire or Sn96,5Ag3Cu0,5 or other lead-free solder wire agreed between user and supplier with a core of non-activated rosin (colophony) flux (Annex D, classification ROL0).

P-4.4 Test board, made of material conforming to GE 4 or FR 4 (glass fibre reinforced epoxy resin) copper-clad laminates (the metallization shall be unpreserved bare copper), with dimensions and patterns as shown in Fig. 7. The pattern shown in Fig. 7 can be found on the IPC-B -25A test board (pattern D). Commercially available test boards meeting the above specifications are acceptable.

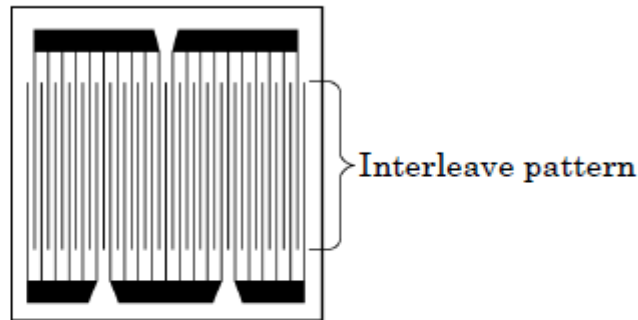

Conductor width : 0.318 mm
Interval between conductors : 0.318 mm
Interleave : 15.75 mm
Board dimension : 50 mm × 50 mm × 1.0 mm to 1.6 mm

FIG. 6 DIMENSIONS AND PATTERN OF TEST BOARD (SOURCE JIS)

P-5 APPARATUSES AND INSTRUMENTS

The usual laboratory apparatus and, in particular, the following shall be used.

P-5.1 Drying oven, suitable for use at up to $120\text{ °C} \pm 3\text{ °C}$.

P-5.2 Solder bath, of jet or stationary type, capable of setting and maintaining the temperature at the test temperature $\pm 3\text{ °C}$.

P-5.3 Hotplate, capable of setting and maintaining the temperature at the set temperature $\pm 3\text{ °C}$.

P-5.4 Humidity chamber, capable of maintaining environments up to 90 °C with temperature control of $\pm 2\text{ °C}$ and relative humidity (RH) up to 95 percent with control of ± 3 percent at a specific RH set point when loaded with test coupons. The chamber shall be constructed with stainless steel inner surfaces and be well insulated. Some solid-state sensors cannot tolerate high temperature and humidity. The temperature and humidity levels of the test chamber shall be recorded throughout the test, preferably with independent control sensors.

If used, independent temperature and humidity sensors should be located in close proximity to the test coupons. Conformance with these conditions will ensure that uniform test conditions can be maintained while the chamber is under test load.

P-5.5 Insulation-resistance meter, capable of measuring up to $10^{14}\ \Omega$ with test voltage 100 V DC.

P-5.6 Coaxial cable.

P-5.7 Spatula or squeegee.

P-5.8 Tongs or other proper jigs, suitable for horizontally lifting up the test specimen from the solder bath.

P-5.9 Soft brush, of about 7 mm in diameter (camel hair or the like).

P-5.10 Scalpel, doctor blade or equivalent, cutting tool for solder wire.

P-5.11 Analytical balance, capable of measuring to an accuracy of 0.000 1 g, for solvent extraction method.

P-5.12 Soxhlet extraction apparatus.

P-5.13 Soldering iron (*see* IS 959 : 1994)

P-6 TEST CONDITIONS

Either of the following test conditions shall apply.

- a) Temperature $40\text{ }^{\circ}\text{C} \pm 2\text{ }^{\circ}\text{C}$, relative humidity (90 ± 3) percent, 168 h; and
- b) Temperature $85\text{ }^{\circ}\text{C} \pm 2\text{ }^{\circ}\text{C}$, relative humidity (85 ± 3) percent, 168 h.

As an alternative to $40\text{ }^{\circ}\text{C} \pm 2\text{ }^{\circ}\text{C} / (90 \pm 3)$ percent RH, it is acceptable to use $40\text{ }^{\circ}\text{C} \pm 2\text{ }^{\circ}\text{C} / (93 \pm 3)$ percent RH. This shall be agreed between users and supplier prior to use. Using 93 percent RH can lead to different results when compared to using 90 percent RH. *See P-12.1* for guidance on which environmental conditions should be used and, *P-12.2* and *P-12.3* for information on specimen integrity during testing.

P-7 TEST PROCEDURE

The test procedure shall be as follows.

P-7.1 Pre-Cleaning of Test Boards

Use a non-contamination method for identifying the test sample (for example vibrating scribe). Permanent ink may be used on the backside of the test coupon if areas beneath conductors are avoided. During this process, handle the samples by the edges only or using non-contaminating gloves.

The test boards shall be preconditioned as follows.

- a) Prepare four test boards, and brush them in distilled or deionized water for 30 s using a soft brush. Use one board as control board;
- b) Splay and rinse with distilled or deionized water thoroughly;
- c) Brush with 2-Propanol for 30 s using a soft brush;
- d) Rinse with 2-Propanol; and
- e) Dry in the drying oven set at the temperature of $60\text{ }^{\circ}\text{C} \pm 3\text{ }^{\circ}\text{C}$ for 3 h.

P-7.2 Confirmation of Insulation Resistance Value of Test Board

Before conditioning of the test specimens, measure the insulation resistance of the test boards using an insulation resistance meter to make sure that it is $10^{13} \Omega$ or higher.

P-7.3 Conditioning of test specimens, as follows.

Tongs etc shall be used for handling test specimens in drying and heating procedures.

P-7.3.1 For Liquid Flux and Paste Flux

Use liquid flux samples, as received (unmodified), as the flux test solution. The test specimens for liquid flux and paste flux shall be conditioned as follows.

P-7.3.1.1 Apply the sample evenly over the interleave pattern of three test boards, ensuring that all the patterns are coated. Use the one board remaining as a control board, without applying flux.

P-7.3.1.2 In the case of flux of which the main solvent is 2-Propanol, dry in a drying oven set at $100 \text{ }^{\circ}\text{C} \pm 3 \text{ }^{\circ}\text{C}$ for 5 min. In the case of other solvent, set the drying oven at the temperature appropriate to the solvent. The temperature recommended by the manufacturer is acceptable.

P-7.3.1.3 Solder the pattern side of the three test boards, to which the sample flux is applied, in a solder bath maintained at a temperature $35 \text{ }^{\circ}\text{C} \pm 3 \text{ }^{\circ}\text{C}$ higher than the liquidus temperature of the solder used for test for $3 \text{ s} \pm 1 \text{ s}$, to prepare test specimens.

P-7.3.1.4 Visually inspect all combs and discard (or replace, if possible) any combs with bridging of conductors or visible (at 10-30 X with backlighting) metallic debris between conductors. Ensure there is no short circuit on the circuit boards. Discard any board exhibiting short circuits, and prepare and condition new circuit boards to prepare test specimens.

P-7.3.2 For Solid Flux

Prepare a solution with mass fraction of 25 percent of the solid flux sample in propan-2-ol, ethanol or other solvent recommended by the flux manufacturer's instructions in which the flux is soluble for carrying out the test. Prepare test specimens in accordance with **7.3.1.1** to **7.3.1.4**.

P-7.3.3 Flux Cored Solder Wire or Preform Samples:

Use the method given in **P-7.3.3.1** or **P-7.3.3.2** as agreed between the purchaser and supplier for preparation of test specimens. In case of dispute, the procedure given in **P-7.3.3.1** shall be referee method.

P-7.3.3.1 Using flux extract or solid flux samples

If the flux is readily available from the flux supplier, prepare a solution with mass fraction of 25 percent of the solid flux sample in propan-2-ol, ethanol or other solvent recommended by the flux manufacturer's instructions in which the flux is soluble for carrying out the test. If a sample of the solid flux used in the cored solder wire or preform is not available from the flux manufacturer, then use the method B of Annex

A to produce 25 mass per cent solution in 2-propanol, reagent grade (or other solvent recommended by the supplier).

Then, prepare the test specimens in accordance with P-7.3.1.1 to P-7.3.1.4.

P-7.3.3.2 *Using flux cored wire itself*

Use the product itself that is cored wire as a sample. Wash the surface of the sample with acetone, rinse with distilled or deionized water, wash with 2-propanol, and dry to use in tests. Using a clean fine-tip soldering iron apply the cored wire to the comb patterns being careful not to bridge the conductors. The iron temperature should be as specified by the cored wire vendor.

P-7.4 *Conditioning of Test Specimens Requiring Washing*

Wash the test boards as follows.

P-7.4.1 After exposure to flux and solder, samples/test coupons to be tested in an uncleaned state (that is those fluxes intended for use on applications where the flux residues will not be cleaned after soldering known as no clean fluxes), shall be tested as per **P-7.6** directly.

P-7.4.2 After exposure to flux and solder, specimens to be tested in the cleaned state shall be cleaned using one of the following procedures and then tested as outlined in **P-7.6**. The cleaning parameters shall be reported in the qualification test report (see Annex C and Annex S for examples of qualification report of fluxes).

P-7.4.2.1 The samples to be cleaned shall be cleaned with an appropriate environmentally safe solvent or aqueous cleaning medium. The use of a commercial in-line or batch cleaner is preferred. If this is not available, the following laboratory cleaning process shall be followed. Samples shall be cleaned within 30 minutes or less after soldering.

P-7.4.2.2 For solvent or aqueous detergent cleaning, three 2000 ml beakers each containing 1000 ml of solvent shall be used such that one beaker serves as the primary cleaning stage and the other two are used for rinsing purposes. Each test coupon shall be agitated in each beaker for one minute. In the case of aqueous detergent, one beaker shall contain the cleaning agent and the remaining beakers shall contain deionized water for rinsing purposes. Beaker solutions shall be used to clean or rinse a maximum of three specimens before the solutions are replaced.

P-7.4.2.3 After the cleaning procedure is complete, specimens are dried for 2 h at 50 °C. Following cleaning, the specimens shall be tested as outlined in **9.4**.

P-7.4.3 Do not subject control coupons to this cleaning process.

P-7.5 *Wiring to Electrodes*

Cover the test patterns with non- contaminating film, such as aluminum foil or plastic film, to prevent flux spattering during the wire attach process. Do not attempt to remove the flux residues.

Solder the coaxial cable with the flux cored solder having the conformance to **P-4.3** for wiring to the electrodes on the test board and the control board.

P-7.6 Operation

The test operation shall be as follows.

P-7.6.1 Before placing test specimens in the temperature/humidity oven, measure the insulation resistance between terminals by means of the insulation-resistance meter at the test voltage of 100 V DC. If the variation in the measured values is found to be $10^2 \Omega$ or greater, condition new test specimens.

P-7.6.2 After connecting coupons in accordance with **P-7.5**, select environmental conditions a) or b), as appropriate.

- a) $40 \text{ }^\circ\text{C} \pm 2 \text{ }^\circ\text{C}$ with a relative humidity (90 ± 3) percent; and
- b) $85 \text{ }^\circ\text{C} \pm 2 \text{ }^\circ\text{C}$ with a relative humidity (85 ± 3) percent.

As an alternative to $40 \text{ }^\circ\text{C} \pm 2 \text{ }^\circ\text{C} / (90 \pm 3)$ percent RH, it is acceptable to use $40 \text{ }^\circ\text{C} \pm 2 \text{ }^\circ\text{C} / (93 \pm 3)$ percent RH. This shall be agreed between users and supplier prior to use. Using 93 percent RH can lead to different results when compared to using 90 percent RH. See **P-12.1** for guidance on which environmental conditions should be used and, **P-12.2** for information on specimen integrity during testing.

P-7.6.3 Place the test specimens in the environmental chamber in a vertical position such that the airflow is parallel to direction of the board in the chamber and seal the chamber (*see* Fig 8). Allow at least 12.5 mm between each test sample to facilitate good airflow between each test coupon. Provision should be made to avoid any water droplets falling or blowing onto the coupons, for example a drip guard may be necessary. If a test rack is being used, a rain shield should be used to avoid the possibility of condensation raining onto the test coupons. Dress all wiring away from the test patterns. Route the wires to the outside of the chamber.

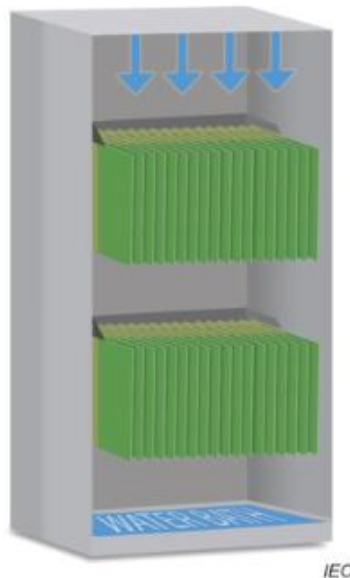

FIG. 7 COUPON ORIENTATION IN TEST CHAMBER (SOURCE IEC)

P-7.6.4 Insert test coupons into the humidity chamber (6.7) and seal the chamber. Without bias applied, ramp from laboratory ambient conditions to $25\text{ }^{\circ}\text{C} \pm 2\text{ }^{\circ}\text{C}$ and (50 ± 3) percent RH and dwell for 1 h and take an initial SIR measurement at - 100 V DC with the test specimens being placed in the oven.

P-7.6.5 Verify the electrical system setup by taking a series of all SIR measurements at these specified ambient conditions. Because classification or ranking of sample performance by SIR at ambient is not appropriate for these test vehicles, clarity suggests that measurements need not be reported unless “shorts” are observed and therefore the corresponding samples are deemed inappropriate for test.

P-7.6.6 Increase the temperature to $40\text{ }^{\circ}\text{C} \pm 2\text{ }^{\circ}\text{C}$ or $85\text{ }^{\circ}\text{C} \pm 2\text{ }^{\circ}\text{C}$, depending on the flux chemistry being evaluated (*see P-12.1* for guidance on which environmental conditions should be used and **P-12.2** for information on specimen integrity during testing.) while maintaining the humidity at (50 ± 3) percent RH and dwell at this temperature for 15 min. After this period, gradually increase, within 30 min, the relative humidity to (85 ± 3) percent RH or (90 ± 3) percent RH depending on the flux chemistry being evaluated (*see P-12.1* for guidance on which environmental conditions should be used and **P-12.2** for information on specimen integrity during testing). Do not allow the temperature of the samples to drop below the dew point. This ramp-up should not exceed 3 h.

P-7.6.6 Allow the specimens to come to equilibrium for at least one hour before applying the bias voltage to begin the test. If a salt solution and desiccator are used for humidity, specimens shall be held for 24 hours before beginning the test. This period is called as stabilization period and also during this period no bias is applied.

P-7.6.7 If the alternative conditions of $40\text{ }^{\circ}\text{C} \pm 2\text{ }^{\circ}\text{C}$ and (93 ± 3) percent RH are being employed, the chamber shall be increased to (93 ± 3) percent RH rather than the (90 ± 3) percent RH referenced above. *See Clause P-12.1.2* for additional details.

P-7.7 Application of Bias Voltage

Now, connect the 45-50v DC voltage source to the specimen test points to apply the bias voltage to all

specimens. Place a 1 M Ω current limiting resistor in series with each test point.

P-8 RESISTANCE MEASUREMENTS

P-8.1 Measurements shall be made with test specimens in the chamber under the test conditions of temperature and humidity at 24, 96 and 168 hours after application of bias. To take these measurements, the 45V – 50V DC bias voltage source must be removed from the test specimen and a test voltage of 100V DC shall be applied. (Test voltage polarity is opposite the bias polarity).

The insulation resistance value on the meter shall be read 1 min after the application of voltage.

NOTE — Each comb pattern requires four test measurements. Measurements are made between (*see* Fig 8 below):

- a) Pad 1 to Pad 2
- b) Pad 3 to Pad 2
- c) Pad 3 to Pad 4
- d) Pad 5 to Pad 4

Pads 2 and 4 are at one potential and pads 1, 3, and 5 are at ground potential. The polarity of the applied voltage is not important as long as the application is consistent (for example pads 1, 3, 5 are positive and 2, 4 are at ground potential, vs. Pads 2 and 4 positive, and Pads 1, 3, 5 at ground potential). Determine the means of the dataset as outlined in 9.

P-8.2 At the end of the test exposure, remove electrical bias from all test patterns prior to temperature-humidity ramp-down initiation. After ramp-down, stabilize the chamber at 25 °C and 50 percent RH for 2 h and take out the specimens for visual examination.

P-8.3 All measurement values are listed in log ohms (base 10 logarithm of the measured resistance). Requirements: no value may fall under 100 megohms (8.0 log ohms) at any time during the test. SIR measurements should be provided in an appropriate graph or table.

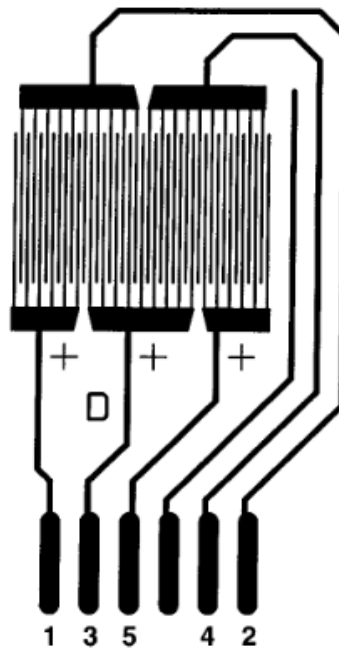

FIG 8 COMB PATTERN BIAS APPLICATION (SOURCE IPC)

P-9 DATA ANALYSIS

P-9.1 The average insulation resistance or geometric mean value of the measurements of the three test specimens is obtained also called as geometric mean for each sample group (here 3 test samples and a total of 12 calculation points), taken at 24 hours 96 hours and 168 hours, shall be greater than the 100 MegaOhms (100 MΩ). If the control coupon readings are less than $10^9 \Omega$, a new set of test specimens shall be obtained and the entire test repeated. The average insulation resistance (IR_{avg}) shall be defined as the geometric mean of the sample set and can be calculated from the following:

$$IR_{avg} = 10 \left[\frac{1}{N} \sum_{i=1}^N \log IR_i \right]$$

Where

N = Number of test points (12 nominal for each set of three patterns); and

IR_i = individual insulation resistance measurements (*see P-12.3* for an example).

No individual insulation resistance value may be more than a factor of 10 below the specified minimum value that is 100 MegaOhms.

P-9.2 Where an assignable cause of low insulation resistance, which is properly attributable to the laminate itself, or to the process used to produce the PCB, can be found, then such a value can be excluded from calculating the average value, provided that at least 10 (of the original 12) test points are included in the average. Such assignable causes include the following:

- a) Contamination on the insulating surface of the board, such as lint, solder splines or water droplets from the chamber;

- b) Incompletely etched patterns that decrease the insulating space between the conductors by more than the amount allowed in the appropriate design requirements drawing;
- c) Scratched, cracked, or obviously damaged insulation between conductors; and
- d) A minimum of 10 test measurements is required for the test to be valid.

P-10 EVALUATION

P-10.1 The geometric mean value/average insulation resistance of the measurements of the three test specimens is obtained, and the evaluation is made based on the insulation resistance of test specimens under the consideration of the following test conditions.

- a) Each sample group shall be evaluated by the insulation resistance values at 24 h, 96 h and 168 h. The average insulation resistance values shall be greater than $10^8 \Omega$. If the control coupon readings are less than $10^9 \Omega$, a new set of test specimens shall be obtained and the entire test repeated;
- b) A temporal drop in the resistance value observed in the middle of the test period (24 h and 96 h) indicates the possibility of adherence of dust etc. inside the oven. In this case, exclude that test value from evaluation;
- c) Extremely low resistance value indicates the possibility of adherence of dew, dust etc. at that position. In this case, take out the test specimen from the temperature/ humidity oven after test, observe by a magnifying glass for any abnormalities, and if abnormality is found, discard that test value; and
- d) The insulation resistance values of the circuit board itself vary; therefore, the board shall be examined for abnormalities, using a control board.

P-10.2 VISUAL EXAMINATION

All specimens shall also be examined under a $10 \times$ to $30 \times$ microscope using backlighting within 24 hours of completing the testing, for evidence of electrochemical migration (filament growth), discoloration, and corrosion. If the coupons are to be held longer, they shall be placed in Kapak® or other non-contaminating container and stored in a desiccator. All samples must be evaluated within seven days. If dendritic growth is observed, it shall be determined if the dendrite spans 20percent or more of the original spacing. This latter condition will constitute a failure. It should be determined whether dendritic growth is due to condensation from the chamber. Visible discoloration, corrosion, or dendritic growth shall be reported.

NOTE — If condensation occurs on the test coupons in the environmental chamber while the coupons are under voltage, dendritic growth or filament formation can occur. Dendritic growth or filament formation can be caused by a lack of sufficient control of the humidification of the oven. Water spotting can also be observed in some ovens where the air flow in the chamber is from back to front. In this case, water condensation on the cooler oven window can be blown around the oven as micro-droplets which deposit on the test coupon surfaces and cause dendritic growth if the spots bridge the distance between electrified conductors. Both of these conditions shall be eliminated for proper testing. It is recommended that a drip shield be placed over and/or around the test samples to prevent water droplets from dropping from the chamber ceiling or from the chamber doors on to the energized test samples. However, the drip shield should also not interfere with good air flow around the test samples, which can require innovative shielding approaches.

P-11 ELECTROCHEMICAL MIGRATION (ECM) TEST

Extend SIR measurement (**P-7.2 to P-10.2**) for 500 h (596 hours in total) and measure the insulation resistance at 24 h, 96 h, 168 h and 500 h, after the placement of the test specimens in the temperature/humidity oven and stabilizing for a period of 96 h at the specific test temperature and humidity.

NOTE — Close the chamber and allow all samples to stabilize for 96 hours at the specific temperature and humidity till the time bias is applied in **P-7.7**.

At the end of the test exposure, remove electrical bias from all test patterns prior to temperature-humidity ramp-down initiation. After ramp-down, stabilize the chamber at 25 °C and 50 percent RH for 2 h and and take out the specimens for visual evaluation in accordance with **P-10.2**.

P-12 GENERAL SIR TESTING GUIDANCE

P-12.1 Test Conditions

P-12.1.1 Fluxes that contain more than a mass fraction of 1 percent organic acid activators, such as adipic acid, that volatilize significantly at 85 °C and less than a mass fraction of 5 percent rosin or modified-rosin resin should be tested at 40 °C and 90 percent RH. Fluxes that contain more than a mass fraction of 0.1 percent ionic halide should be tested at 85 °C and 85 percent RH.

NOTE — Some weak organic acid-containing fluxes have volatile residues which can be driven off at higher test temperatures than those experienced in environmental conditions.

P-12.1.2 Humidity (90 Percent RH or 93 Percent RH)

IEC 60068-2-78 includes a set of damp heat conditions of 40 °C ± 2 °C and (93 ± 3) percent RH whereas SIR testing has traditionally employed the same temperature but the lower humidity value of 90percent RH ± 3 percent RH. The historical reason for this difference is that with the 3 percent tolerance applied to 93 percent RH, condensation would typically occur at the high end of the tolerance (for example 95 percent RH to 96 percent RH) and this in turn would lead to ‘rain’ in the chamber which could in turn fall on the coupons, something that shall be avoided in this SIR test. Based on this, the default humidity value for SIR testing in the industry became (90 ± 3) percent RH. This 90 percent RH value continues to be referenced in the industry and is the default value provided in this test method for no-clean fluxes. With the development of some modern damp-heat chambers, it is now possible to employ (93 ± 3) percent RH without creating ‘rain’ in the chamber and as such, this humidity option has been permitted in this test method as an alternative to (90 ± 3) percent RH, providing it is first agreed between user and supplier. Without this agreement, the 90 percent RH value is to be used for no-clean flux chemistries. User and supplier should be aware that 93 percent RH may lead to different results to those seen when using 90 percent RH and as such direct comparisons of values produced using these two different humidity levels should be conducted with caution.

P-12.2 Risk of Condensation

If condensation occurs on the test coupons in the environmental chamber while the coupons are under voltage, dendritic growth or filament formation can occur. Dendritic growth or filament formation can be caused by a lack of sufficient control of the humidification of the oven. Water spotting can also be

observed in some ovens where the air flow in the chamber is from back to front. In this case, water condensation on the cooler oven window can be blown around the oven as micro-droplets which deposit on the test coupon surfaces and cause dendritic growth if the spots bridge the distance between electrified conductors. Both of these conditions shall be eliminated for proper testing.

P-12.2.1 Precautions

It is recommended that a drip shield be placed over and/or around the test samples to prevent water droplets from dropping from the chamber ceiling or from the chamber doors on to the energized test samples. However, the drip shield should also not interfere with good air flow around the test samples, which can require innovative shielding approaches.

P-12.3 Example of Geometric Mean Calculation

IR_{avg} is also referred to as the geometric mean of the data set. Most spreadsheet packages contain functions for calculating the geometric mean of a data set. If you are computing the geometric mean of a large dataset, the spreadsheet may come back with an error because the number is so large. In such cases, use the antilog of the LogOhm average to arrive at the geometric mean. See the following example:

Example — Three 5-point test patterns (4 measurements each)
 LogOhms = base-10 logarithm of measured resistance ($\log_{10} \Omega$)

<i>Sl No.</i>	<i>Measurement No.</i>	<i>Resistance in Ohms (Ω)</i>	<i>LogOhms($\log_{10} \Omega$)</i>
(1)	(2)	(3)	(4)
i)	1	3.98×10^{11}	$\log_{10} 3.98 \times 10^{11} = 11.60$
ii)	2	1.58×10^{11}	$\log_{10} 1.58 \times 10^{11} = 11.20$
iii)	3	6.31×10^{11}	$\log_{10} 6.31 \times 10^{11} = 11.80$
iv)	4	7.94×10^{11}	$\log_{10} 7.94 \times 10^{11} = 11.90$
v)	5	1.00×10^{12}	$\log_{10} 1.00 \times 10^{12} = 12.00$
vi)	6	1.00×10^{12}	$\log_{10} 1.00 \times 10^{12} = 12.00$
vii)	7	3.98×10^{11}	$\log_{10} 3.98 \times 10^{11} = 11.60$
viii)	8	1.58×10^{12}	$\log_{10} 1.58 \times 10^{12} = 12.20$
ix)	9	1.26×10^{12}	$\log_{10} 1.26 \times 10^{12} = 12.10$
x)	10	1.26×10^{12}	$\log_{10} 1.26 \times 10^{12} = 12.10$
xi)	11	1.00×10^{12}	$\log_{10} 1.00 \times 10^{12} = 12.00$
xii)	12	3.98×10^{11}	$\log_{10} 3.98 \times 10^{11} = 11.60$

$$\text{Average of LogOhms } (\log_{10} \Omega) = \frac{\sum_{n=1}^{n=N} \log_{10} \Omega_n}{N}$$

$$= \frac{\sum_{n=1}^{12} \log_{10} \Omega_1 + \log_{10} \Omega_2 + \dots \log_{10} \Omega_{12}}{12} = 11.84$$

Geometric Mean of Average Insulation resistance = IR_{avg} = Antilog of $\frac{\sum_{n=1}^N \log_{10} \Omega_n}{N}$

$$= 10^{\frac{\sum_{n=1}^N \log_{10} \Omega_n}{N}} = \left(10^{\log_{10} \Omega_1 \times \log_{10} \Omega_2 \times \dots \log_{10} \Omega_N}\right)^{\frac{1}{N}}$$

$$= \left(10^{\log_{10} \Omega_1 \times \log_{10} \Omega_2 \times \dots \log_{10} \Omega_{12}}\right)^{\frac{1}{12}} = 6.94 \times 10^{11}$$

$$\therefore IR_{avg} = 6.94 \times 10^{11}$$

ANNEX Q

(Foreword, Annex B, Clauses D-4.1.4 and D-4.1.5)

SURFACE INSULATION RESISTANCE COMB TEST AND ELECTROCHEMICAL
MIGRATION TEST OF FLUX RESIDUES

Q-1 SCOPE

This test method is used to characterize the effects of flux residues on electrical performance by determining the degradation of electrical insulation resistance under conditions of high temperature and humidity.

This test method specifies a method of testing for deleterious effects that can arise from flux residues after soldering or tinning test coupons. The test is applicable to fluxes specified in Annex D, in solid or liquid form, or in the form of flux-cored solder wire, solder preforms or solder paste constituted with eutectic or near-eutectic tin/lead (Sn/Pb) or Sn95.5Ag3Cu0.5 or other lead-free solders as agreed between user and supplier (*see* IS193).

Interdigitated comb patterns comprising long parallel electrodes on an IPC B53 standardized test coupon are used for the evaluation. Coupons are conditioned and measurements taken at a high temperature and humidity. The electrodes are electrically biased during conditioning to facilitate electrochemical reactions, as shown in Fig. 10 and Fig. 11.

The test employs two different test conditions of 85 °C and 85 percent relative humidity (RH), preferred for a process that includes cleaning, or 40 °C and 90 percent relative humidity (RH), preferred for processes where no cleaning is involved.

NOTE — 40 °C and 93 percent RH can be used as an alternative to 40 °C and 90 percent RH. Additional information is provided in 9.1.2 Q-7.1.2, Q-7.4.2 and M-5.2.

Reference can be made to **IEC TR 61189-5-506**, which examines different geometry comb patterns: 400 µm × 500 µm; 400 µm × 200 µm; and 318 µm × 318 µm.

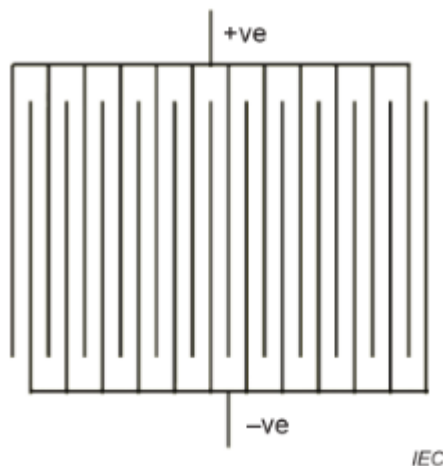

FIG. 9 SIR PATTERN (SOURCE IEC)

Q-2 PRINCIPLE

The objective of this test method is to characterize fluxes by determining the degradation of electrical resistance and the electrochemical migration of rigid printed wiring coupon specimens after exposure to the specified flux. This test is carried out at high humidity and heat conditions under bias voltage. For fluxes which can leave undesirable residues and hence require cleaning, the results obtained from the test will depend on the characteristics of the flux residue, substrate and metallization, and also on the effectiveness of the cleaning operation.

The measurement of surface insulation resistance (SIR) makes use of a printed wiring coupon substrate having one or more conductive interleaved test patterns. Prior to being subjected to conditioning, the interleaved test patterns are fluxed, soldered or tinned, and cleaned (when required). The patterns are then exposed to a controlled environment for a specified time with an applied voltage. The surface insulation resistance is measured using insulation test apparatus at a suitable test voltage while the test coupons are in the controlled environment. Annex D provides further information on SIR testing.

Q-3 REAGENTS

Use only reagents of recognized analytical grade or higher and only distilled or deionized water with a conductivity of less than 0.05 $\mu\text{S}/\text{cm}$ (resistivity $\geq 20 \text{ M}\Omega$).

Q-3.1 Propan-2-ol, $(\text{CH}_3)_2\text{CHOH}$ or other suitable solvent.

Q-3.2 Cleaning solvent (if required), recommended by the flux manufacturer as suitable for the removal of post-soldering flux residues or propan-2-ol.

Q-4 APPARATUS

Equipment shall be capable of demonstrating repeatability in accordance with the gauge r and R methodology specified in IS 15393 (Part 2). The usual laboratory apparatus and, in particular, the following shall be used.

Q-4.1 Low profile container, for example a Petri dish or a watch glass.

Q-4.2 Drying oven, suitable for use at up to $120 \text{ }^\circ\text{C} \pm 3 \text{ }^\circ\text{C}$.

Q-4.3 Insulated wire or cable, 1 000 V general-purpose wire, temperature rated to $150 \text{ }^\circ\text{C}$; primary insulation of radiation-crosslinked; configuration suitable for equipment in use.

For consistent and repeatable results, it is important that all cabling carrying test signals be encased in an electromagnetic shield. Most often, this is a metallic foil or braid material. Since SIR measurement often deals with picoamperes of current or less, electromagnetic coupling (EMC) and other stray electrical fields can unduly affect the test signals. Encasing the signal lines with a grounded metal dramatically reduces currents due to EMC and other electrical noise. It is not necessary to individually shield each line, such as in coaxial cabling, but separating voltage supply lines and current

return lines is recommended. A single EMC shield can be used to encase all current-return lines.

Q-4.4 Connector, 64-position, glass filled polyester body with the following properties:

- 1.27 mm × 10.67 mm (0.05 in × 0.42 in) on 2.54 mm (0.10 in) centres;
- 32 tabs, gold-plated over nickel plate over copper;
- 0,762 μm (0,000 03 in) gold plated post/pin mating end;
- bifurcated beam contacts;
- for coupon thickness of 1.40 mm to 1.78 mm (0.055 in to 0.070 in);
- capable of resisting temperatures up to 105 °C.

The IR (insulation resistance) of pin-to-pin at the connector shall have a resistance under climate and temperature conditions, with a minimum of 1 012 Ω under test conditions. The connector shall be suitable for use under different test conditions.

Q-4.5 Test coupon

The test pattern IPC B53 according to IEC 61189-5-501, as shown in [Fig. 11](#), shall be used for the test specimen. Of the six comb patterns, A and B patterns have 0.4 mm line width and 0.2 mm spacing, comprising 5 207 squares (IEC 61189-5-501); C and D patterns have 0.4 mm line width and 0.5 mm spacing, comprising 1 038 squares (IPC B24); and E and F patterns have 0.318 mm line width and 0.318 mm spacing, comprising 1 981 squares (Bellcore).

Pattern G (the central Y pattern), and the squares and dots (adhesion test pattern) identified as A and B, are not a requirement for SIR testing; all other test patterns shall be evaluated as part of this test.

The specimen is approximately 150 mm × 95 mm in size. The conductive patterns shall be either unpreserved bare copper or finished with electroless nickel gold (ENIG).

- 32 tabs, gold-plated over nickel plate over copper;
- 1.27 mm × 10.67 mm (0.05 in × 0.42 in) on 2.54 mm (0.10 in) centres.

The test pattern shall comply with Table 11 and the test coupon shall comply with Fig. 11:

Table 11 Test pattern
(Clauses Q-4.5 and Q-7.2.1)

Type of SIR test patterns	A and B	C and D	E and F
Width of conductor	0.4 mm	0.4 mm	0.318 mm
Spacing of conductor	0.2 mm	0.5 mm	0.318 mm
Overlap length	25.4 mm	15.25 mm	15.75 mm
Overlapping spaces	41	34	40
Squares (nominal)	5 207	1 038	1 981

NOTE — Spaces are determined by counting the number of overlapping areas per pattern. Squares are determined by:

$$\frac{l_o \times n_s}{w_s} = q$$

where

l_o length of overlap

n_s number of spaces

q number of squares

w_s spacing width

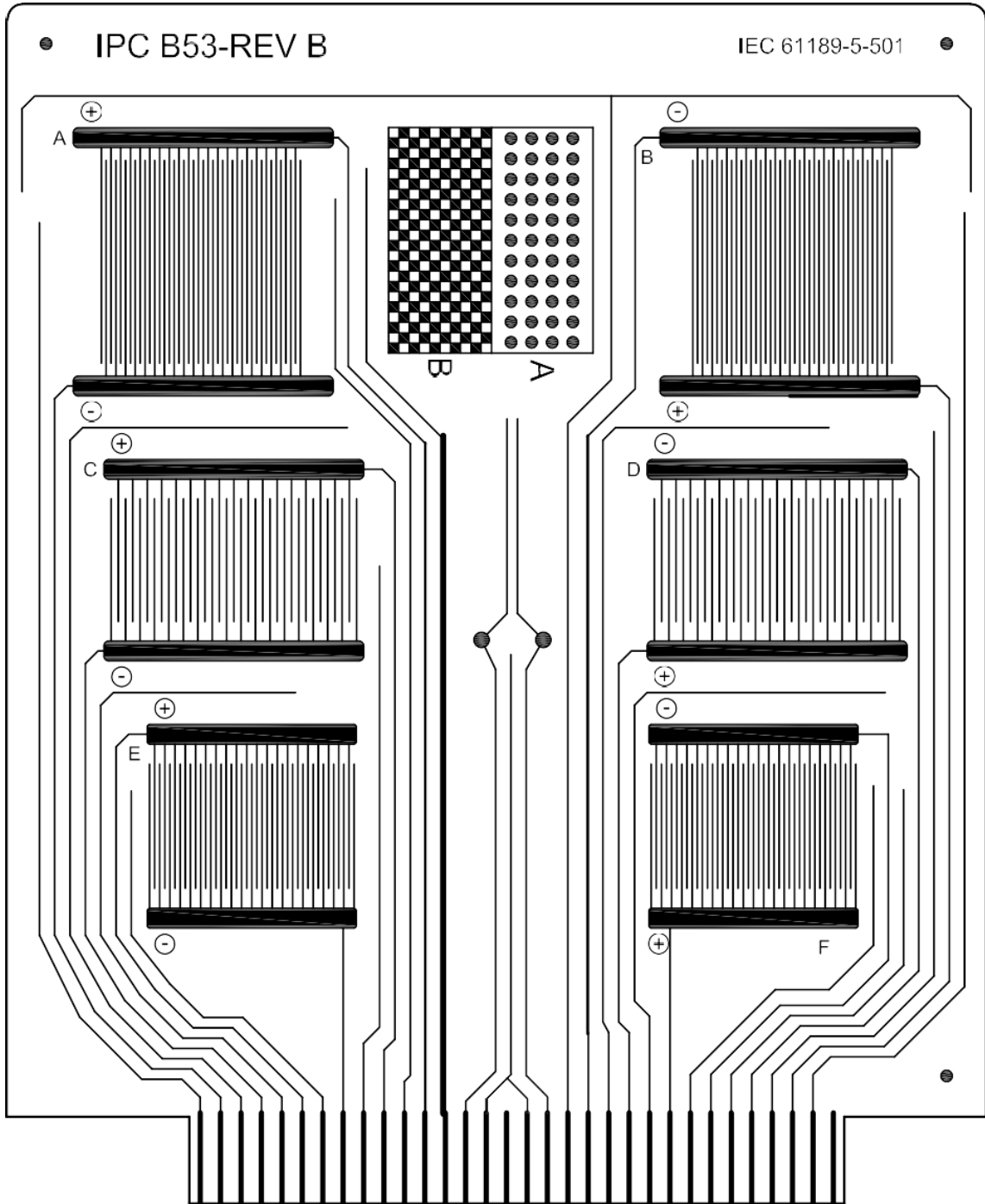

FIG. 10 IPC B53-REV B TEST COUPON (SOURCE ISO 9455-17 : 2024)

Q-4.6 Soldering Equipment

Q-4.6.1 Flux-Cored Solder Wire

If cabling is connected by soldering, non-activated rosin flux of Annex D, classification ROL0, shall be used, tin/lead or lead-free solder shall be agreed between user and supplier conforming to eutectic or near-eutectic tin/lead (S Sn60Pb40E or S Sn63Pb37) or lead-free solder (Sn95.5Ag3Cu0.5) or other lead-free solders as agreed between user and supplier, (*see* IS 193).

NOTE—This wire consists of 60/40 or 63/37 tin/lead solder wire or Sn96.5Ag3Cu0.5 or other lead-free solder wire agreed between user and supplier with a core of non-activated rosin (colophony) flux (Annex D, classification ROL0).

Q-4.6.2 Wave Solder System

Comprising a wave-soldering machine with the solder in a bath. Tin/lead or lead-free solder shall be agreed between user and supplier and conform to eutectic tin/lead (Sn63Pb37) or lead-free solder (Sn95.5Ag3Cu0.5 or other lead-free solders as agreed between user and supplier, *see* IS 193). The set point temperature shall be maintained to ± 5 °C.

Q-4.6.3 Static Bath

Containing solder to a depth of not less than 40 mm. Tin/lead or lead-free solder shall be agreed between user and supplier and conform to grade Sn63Pb37E or Sn96,5Ag3Cu0,5 or other lead-free solder agreed between user and supplier. The set point temperature shall be maintained to ± 5 °C.

Q-4.6.4 Soldering Iron (*see* IS 959)

Q-4.7 Humidity chamber, capable of maintaining environments up to 90 °C with temperature control of ± 2 °C and relative humidity (RH) up to 95 percent with control of ± 3 percent at a specific RH set point when loaded with test coupons. The chamber shall be constructed with stainless steel inner surfaces and be well insulated. Some solid-state sensors cannot tolerate high temperature and humidity. The temperature and humidity levels of the test chamber shall be recorded throughout the test, preferably with independent control sensors.

If used, independent temperature and humidity sensors should be located in close proximity to the test coupons. Conformance with these conditions will ensure that uniform test conditions can be maintained while the chamber is under test load.

Q-4.8 High-resistance measurement system, capable of measuring surface insulation resistance (SIR) in the range of at least 10^6 Ω to 10^{12} Ω . It shall be capable of measuring and recording each individual test channel/pattern. The measurement circuit shall incorporate a 1 M Ω current limiting resistor in each current pathway.

The tolerance of the total measurement system shall be ± 5 percent up to 10^{10} Ω , ± 10 percent between

$10^{10} \Omega$ to $10^{11} \Omega$, and ± 20 percent above $10^{11} \Omega$. If a different test voltage is to be used, the measurement circuit shall be assessed at that voltage rather than the 5 V stipulated. See Clause A.5 for additional information on test voltages.

The instrument can be used with either an external or internal power supply but shall be capable of delivering a variable voltage from (5 to 100) V DC ± 1 percent with a 1 M Ω load and a channel to channel isolation resistance of $10^{13} \Omega$.

The system shall be capable of taking measurements in the time interval required.

Equipment shall have the measurement capability to repeat the resistance measurement on all channels at least every 20 minutes.

Q-4.9 Resistor verification coupon, with the same dimensions as the test coupon, with four resistors with the values $10^6 \Omega$, $10^8 \Omega$, $10^{10} \Omega$ and $10^{12} \Omega$ in specific current pathways as shown on Fig 12. It shall have a protective metal (stainless steel) cover attached with stainless hardware to the grounded mounting holes on the coupon to protect the resistors from contamination or damage during handling (*see* Fig 13).

Q-4.10 Soft bristle brush.

Q-4.11 Scalpel, doctor blade or equivalent, cutting tool for solder wire.

Q-4.12 Analytical balance, capable of measuring to an accuracy of 0.000 1 g, for solvent extraction method.

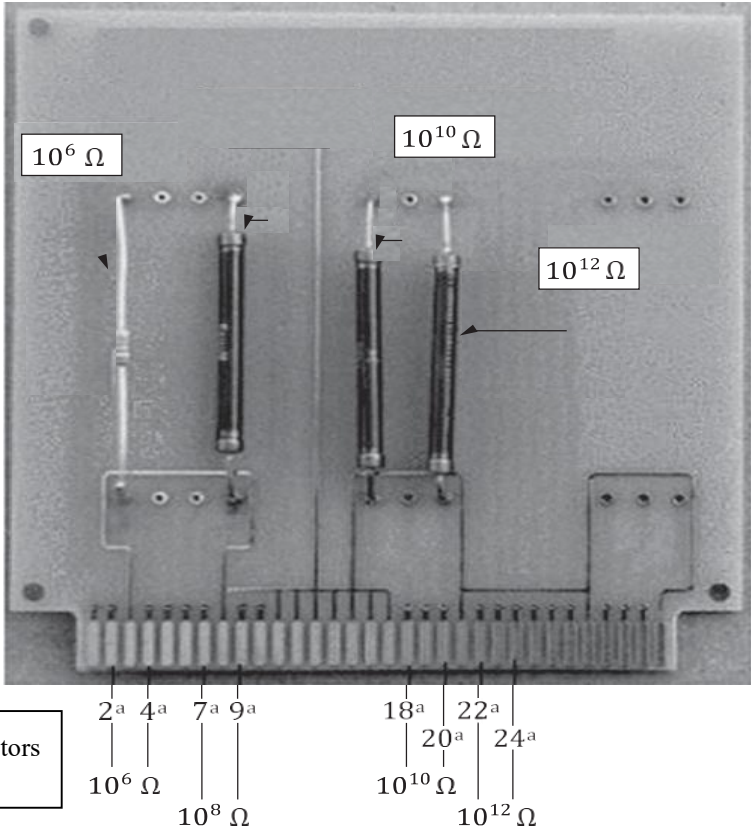

^a Test coupon tab connectors

FIGURE 11 RESISTOR VERIFICATION COUPON

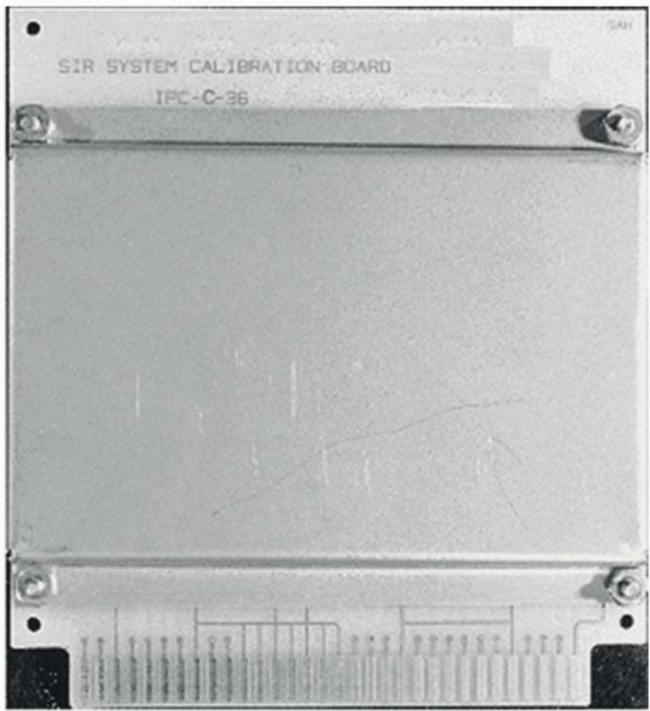

FIG. 12 RESISTOR VERIFICATION BOARD WITH PROTECTIVE COVER

Q-4.13 Test coupon fixing device, capable of uniformly spacing coupons (minimum of 15 mm), parallel to air flow with the connector (if present), in accordance with Fig. 8 and Fig. 14.

Q-4.14 Soxhlet extraction apparatus.

Q-4.15 Camera, for recording full colour photographs of test coupons.

Q-4.16 Backlight panel, suitable for inspecting test coupons for evidence of dendritic growth or other anomalies.

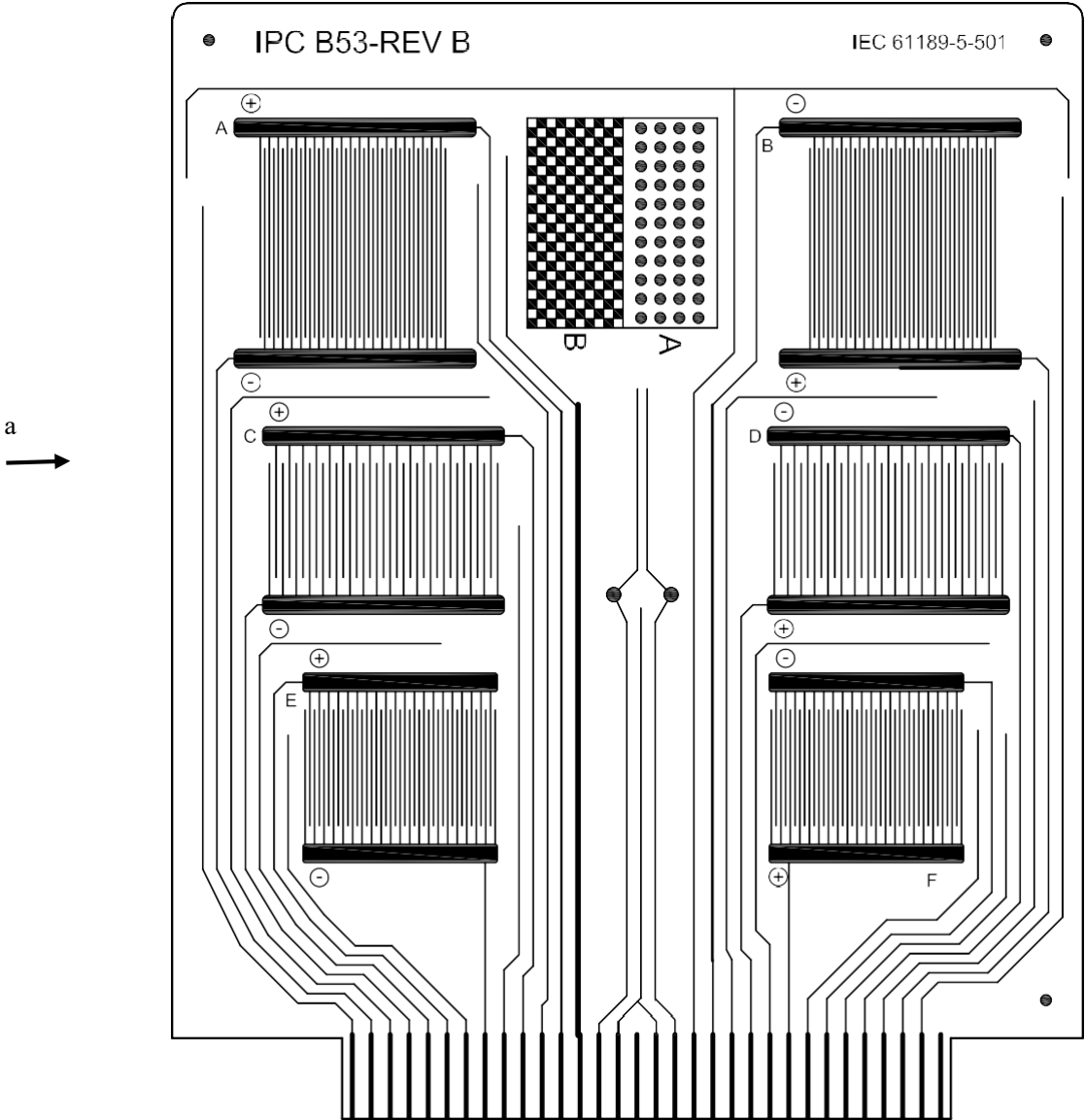

FIG. 13 IPC B53-REV B TEST COUPON LOCATION WITH RESPECT TO CHAMBER AIR FLOW

a Air flow.

Q-5 INSPECTION OF TEST COUPONS

Q-5.1 Surface Plating

Q-5.1.1 *Slivering (Thin Metal Overhang on Etch Runs)*

Copper tracks on test coupons shall be free of slivering since the slivers are prone to breaking off with the associated possibility of creating electrical short circuits during SIR testing.

NOTE — Slivering is sometimes associated with surface plating or etching

Q-5.1.2 *Plating Nodules*

Plating nodules on the edges of etch runs shall be kept to a minimum and in no case shall nodules violate minimum conductor design electrical spacing requirements. Nodules, if present, shall not be loose nor flake on to the laminate substrate.

Q-5.1.3 *Plating Pits*

All conductors and plated-through lands shall be free of plating pits. Gold-plated card edge connector pads shall be free of plating pits that expose copper or nickel.

Q-5.2 Surface Laminate

Measles or crazing of the bare printed coupon, if present, shall not exceed 1 percent of the coupon area. There shall be no more than 25 percent reduction in space between electrically uncommon conductors due to measling or crazing. A separate determination shall be made for each side of the coupon.

The area of measling or crazing is determined by combining the area of each meale or craze and dividing by the total area of the printed coupon.

The referee test (destructive) to determine propagation of measling or crazing is to pre-condition the test coupon and then solder-float the specimen on a solder bath at a temperature of $(260 \pm 5) ^\circ\text{C}$ for a period of 5 s.

Total measling or crazing of the assembled test coupon shall not exceed 2 percent of the test coupon area. There shall be no more than a 50 percent reduction in the space between electrically uncommon conductors.

The area of measling or crazing is determined by combining the area of each meale or craze and dividing by the total area of the printed coupon. A separate determination is made for each side of the coupon.

Conductor edges, if not smooth and even, shall be within design tolerances.

Q-6 SAMPLE PREPARATION

Q-6.1 Preparation of the Flux Test Solution

Q-6.1.1 *Solid Flux Samples*

Prepare a solution with mass fraction of 25 percent of the solid flux sample in propan-2-ol, ethanol or other solvent recommended by the flux manufacturer's instructions.

Q-6.1.2 *Flux-Cored Solder Wire or Preform Samples*

If a sample of the solid flux used in the cored solder wire or preform is not available from the flux manufacturer, then use the following method to prepare samples otherwise prepare a solution with mass fraction of 25 percent of the solid flux sample as given in **Q-6.1.2**.

Cut a length of the flux-cored solder wire or preform weighing approximately 150 g and seal the ends by crimping. Wipe the surface clean with a cloth moistened with propan-2-ol (**Q-3.1**). Place the sample in a beaker, add sufficient water to cover the sample and boil for 5 min to 6 min. Remove the sample, rinse with propan-2-ol and allow to dry.

Protecting the solder surface from contamination, cut the sample into 3 mm to 5 mm lengths using a scalpel (**Q-4.11**) and avoid crimping the cut ends. Weigh and place the cut segments into the extraction tube of a clean Soxhlet extraction apparatus (**Q-4.14**) and extract the flux with propan-2-ol, or other suitable solvent (**Q-3.2**) until the return condensate is clear. Calculate the approximate non-volatile matter content of the extract from the loss in mass of the segments and the volume of the extract.

To produce the flux test solution, adjust the non-volatile matter content of the extract to a mass fraction of 25 percent, by evaporation or by dilution with the solvent used during the extraction stage.

Q-6.2 Preparation of the Test Coupons

Q-6.2.1 *Sample Identification*

Following inspection, in accordance with *clause Q-5*, mark test coupons using a positive, permanent and non-contaminating method, for example with an engraving tool, so that they can be identified.

Q-6.2.2 *Test Coupons*

The preparation and number of test coupons shall be in accordance with Table 12 and is dependent

on the sample group. Include a minimum of two control coupons for each test run in each test chamber.

Each test coupon shall comprise six test patterns as described in Q-4.5.

For Group A, prepare a minimum of three test coupons for each solid flux and flux-cored solder wire to be tested in the cleaned state. If more than three test coupons are used, report all results. When testing fluxes which are intended to remain in the uncleaned state use six test coupons. Wave solder three uncleaned test coupons pattern side down (group B of Table 12) and three test coupons pattern side up (group C of Table 12).

In addition, there shall be at least two unprocessed control coupons for comparison purposes (Table 12, Sample Group F).

Preconditioning of SIR test coupons (see Q-7.1.2) may be used to determine initial coupon cleanliness levels.

Table 12 Minimum number of Coupons for SIR testing
(Clauses Q-6.2.2 and Q-7.2.1)

Sample group	Flux/solder	Clean	Number of coupons
(1)	(2)	(3)	(4)
A	Yes	Yes	3
B	Yes	No	3
C	Yes	No	3
D	Yes	Yes	3
E	Yes	No	3
F	No	No	2
A = pattern down/clean B = pattern down/no clean C = pattern up/no clean D = solder paste/reflow/clean E = solder paste/reflow/no clean F = control (pre-cleaned, unprocessed)a			

Q-6.2.3 Test Coupon Pre-Cleaning

Q-6.2.3.1 Pre-clean each test or control coupons using one of the following methods:

- a) Gently brush under deionized or distilled water using a soft bristle brush (6.10) for 30 s. Spray-rinse thoroughly with deionized or distilled water. Then rinse the cleaned area thoroughly with fresh propan-2-ol (Q-3.1);

- b) Place the test coupons in an ionic contamination tester containing one of the following test solutions:
- 1) a volume fraction of 75 percent propan-2-ol, 25 percent deionized water solution;
 - 2) a volume fraction of 50 percent propan-2-ol, 50 percent deionized water solution.

Process until a resistivity measure of $> 20 \text{ M}\Omega$ has been achieved /all ionics have been removed.

Q-6.2.3.2 During the remainder of the specimen preparation, handle test coupons by the edges only, and use non-contaminating lint free rubber gloves.

Q-6.2.3.3 Dry the cleaned board for two hours at 50°C in the drying oven.

Q-6.2.3.4 If boards/test coupons/specimens are to be stored before treatment, place the boards in Kapak® bags or other contamination free containers in a desiccator.

Q-7 PROCEDURE

Q-7.1 Methods for Connecting Test Coupons to the Measurement System

Q-7.1.1 *Board Circuitry Layout*

Q-7.1.1.1 *Methods of connection*

Connect the test coupons as shown on Fig. 5 and by either hardwiring in accordance with **Q-7.1.1.2** or connector interfacing in accordance with **Q-7.1.1.3**. In the event of dispute, the samples with soldered wires shall be used as referee.

NOTE — See **R-11** for guidance on the advantages and disadvantages of using connectors as part of the measurement system.

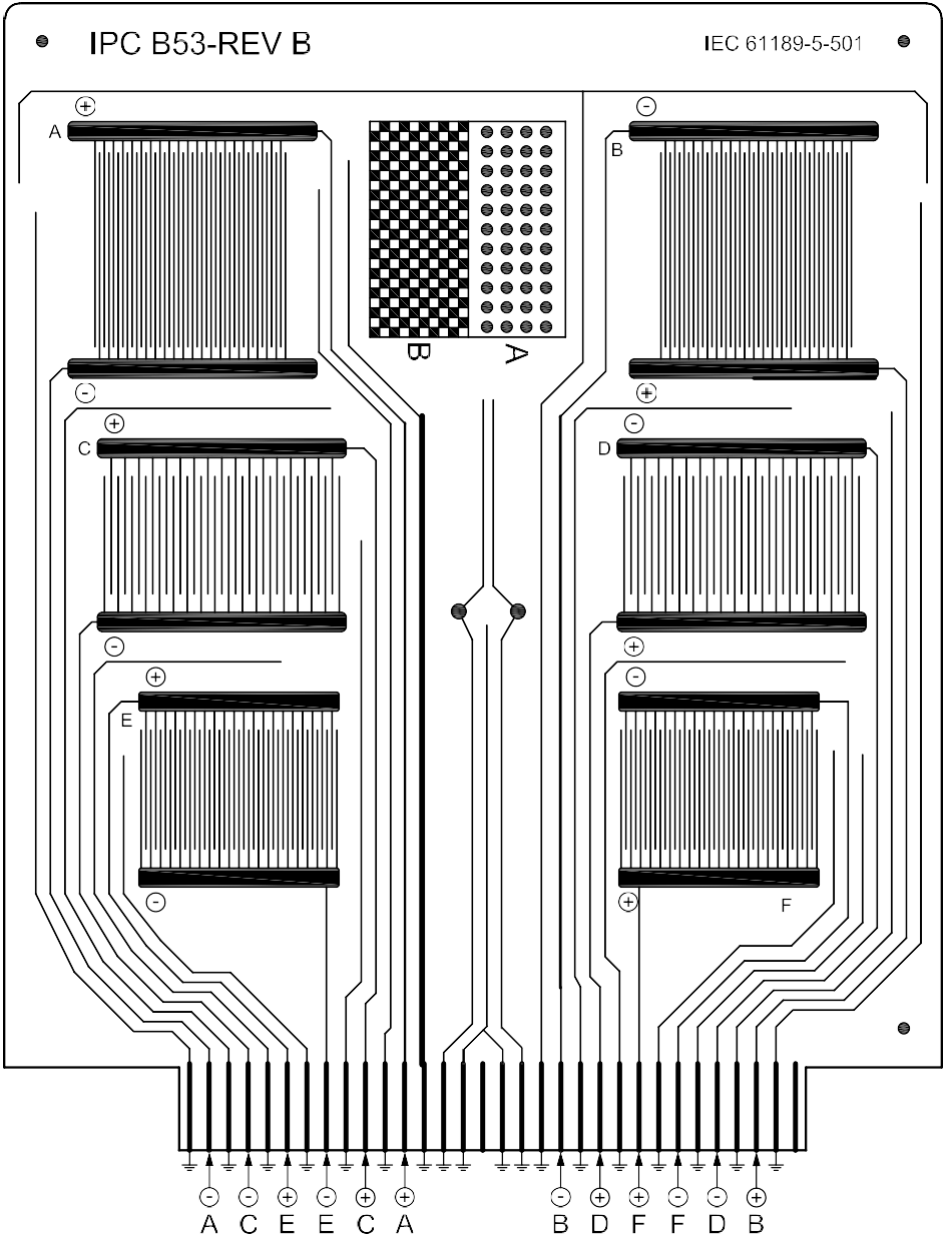

FIG. 14 IPC B53-REV B TEST COUPON CONNECTIONS ACCORDING TO IPC-TM-650

Key
⊥ earth

Q-7.1.1.2 Hard wiring

For each test coupon (Q-4.5), first cover the patterns to be tested with aluminium foil to protect them from contamination during interconnect attachment soldering.

The aluminium foil should be configured to tent the patterns but not to touch them.

Solder a suitably insulated wire (Q-4.3) to the appropriate coupon tab (see Fig 14) using a soldering

iron (Q-4.6.4) and flux-cored solder wire (Q-4.6.1). Use a minimum amount of solder to make each joint and do not allow solder or flux to contaminate the test pattern. Tag each wire so that it can be identified outside the humidity chamber. Do not attempt to remove the flux residues.

Q-7.1.1.3 Connector interfacing

When connectors are used, slide coupon edge pads into the connector, mating the gold coupon tabs to the corresponding gold finish connector tabs.

Some users will use fixtures with gold plated pins to interconnect with the gold coupon tabs. In such cases, the same requirements apply.

Q-7.1.2 Preconditioning Of SIR Test Coupons Prior to Processing (Optional)

This option is intended for users who wish to verify the cleanliness (in terms of SIR) of the test coupons prior to fluxing and soldering. Connect the coupons (*see* Q-7.1.1.1). Precondition coupons for a period of 8 h to 16 h in the humidity chamber (Q-4.7), programmed for the appropriate test condition, as follows:

- a) $40\text{ }^{\circ}\text{C} \pm 2\text{ }^{\circ}\text{C}$ with a relative humidity of (90 ± 3) percent; and
- b) $85\text{ }^{\circ}\text{C} \pm 2\text{ }^{\circ}\text{C}$ with a relative humidity of (85 ± 3) percent.

As an alternative to $40\text{ }^{\circ}\text{C} \pm 2\text{ }^{\circ}\text{C}$ and (90 ± 3) percent RH, it is acceptable to use $40\text{ }^{\circ}\text{C} \pm 2\text{ }^{\circ}\text{C}$ and (93 ± 3) percent RH. This shall be agreed between users and supplier prior to use. Using 93 percent RH can lead to different results when compared to using 90 percent RH. See R-5 for guidance on which test condition should be used. See R-6 and R-7 for information on specimen integrity during testing.

Take SIR measurements (*see* Q-7.4) at the end of the preconditioning period at the test conditions.

NOTE— *see* R-8 for information about frequency of monitoring during SIR testing.

Q-7.2 Fluxing and Soldering Test Patterns

Q-7.2.1 Liquid Flux or Flux Extract of Cored Wire

Protect edge connector tabs from flux and solder contamination on all coupons. Solder test patterns, listed in Table 11, circuit-side down in accordance with Q-7.2.1.1 or Q-7.2.1.2.

Do not flux or solder the control test patterns. If the flux residues are not designed to be cleaned during production (*see* Q-6.2.2), a second set of test patterns shall be fluxed and floated pattern up on the solder pot or passed pattern up over the solder wave.

After soldering, examine the test patterns or combs and discard (or replace, if possible) any combs with bridging of conductors or visible metallic debris between conductors at 10-30X with

backlighting. Discard data from any test patterns exhibiting short circuits. Add additional coupons to maintain the number of required test patterns specified in Table 12.

Q-7.2.1.1 *Soldering using wave solder system*

Liberal apply the flux test solution obtained in **Q-6.1.1** or **Q-6.1.2**, as appropriate, to the pattern side of the test coupons (**Q-4.5**), ensuring that the test patterns are coated. Wave solder using a solder schedule which achieves topside preheat temperature as recommended by the flux manufacturer and a dwell time/contact time in the solder pot of $3 \text{ s} \pm 1 \text{ s}$ at a solder temperature between $245 \text{ }^\circ\text{C}$ and $260 \text{ }^\circ\text{C}$ for Sn63Pb37E or Sn96.5Ag3Cu0.5 or liquidus point $+30 \text{ }^\circ\text{C} \pm 5 \text{ }^\circ\text{C}$ of the solder for other lead-free solder agreed between user and supplier.

Q-7.2.1.2 *Soldering using static solder pot*

Liberal apply the flux test solution obtained in **Q-6.1.1** or **Q-6.1.2**, as appropriate, to the pattern side of the test coupons (**Q-4.5**), ensuring that all the patterns are coated. Allow the excess flux to drain off by standing the coupons vertically on absorbent paper for 10 s. Dry the coupons for 5 min in the drying oven (**Q-4.2**), maintained at $(100 \pm 3) \text{ }^\circ\text{C}$.

Solder by floating the test coupon on a static solder pot maintained between $245 \text{ }^\circ\text{C}$ and $260 \text{ }^\circ\text{C}$ for Sn63Pb37E or Sn96.5Ag3Cu0.5 or liquidus point $+30 \text{ }^\circ\text{C} \pm 5 \text{ }^\circ\text{C}$ of the solder for other lead-free solder agreed between user and supplier with a dwell time/contact time in the solder pot of $4 \text{ s} \pm 1 \text{ s}$. Be sure that all dross is removed from the solder pot surface just before the contact with the specimen.

Q-7.2.2 *Cored Wire*

Using a clean fine-tip soldering iron apply the cored wire directly to the comb patterns being careful not to bridge the conductor. The iron temperature should be as specified by the flux cored solder wire manufacturer.

Q-7.3 **Cleaning of Samples**

Q-7.3.1 After exposure to flux and solder, samples/test coupons to be tested in an uncleaned state (that is those fluxes intended for use on applications where the flux residues will not be cleaned after soldering known as no clean fluxes), shall be tested as outlined in **Q-7.4**.

Q-7.3.2 After exposure to flux and solder, specimens to be tested in the cleaned state shall be cleaned using one of the following procedures and then tested as outlined in **Q-7.4**. The cleaning parameters shall be reported in the qualification test report (*see Annex C and Annex S for qualification report of fluxes*).

Q-7.3.2.1 The specimens to be cleaned shall be cleaned with an appropriate environmentally safe solvent or aqueous cleaning medium. The use of a commercial batch or in-line cleaner is preferred.

If this is not available, the following laboratory cleaning process shall be followed. Samples shall be cleaned within a maximum of 30 min after soldering.

Q-7.3.2.2 For solvent or aqueous detergent cleaning, three 2 000 ml beakers each containing 1 000 ml of solvent shall be used so that one beaker serves as the primary cleaning stage and the other two are used for rinsing purposes. Each test specimen shall be agitated in each beaker for 1 minute. In the case of aqueous detergent, one beaker shall contain the cleaning agent and the remaining beakers shall contain deionized water for rinsing purposes. Beaker solutions shall be used to clean or rinse a maximum of three specimens before the solutions are replaced.

Q-7.3.2.3 After the cleaning procedure is complete, specimens are dried for 2 h at 50 °C. Following cleaning, the specimens shall be tested as outlined in **Q-7.4**.

Q-7.3.3 Do not subject control coupons to this cleaning process.

Q-7.4 Surface Insulation Resistance (SIR) Test

Q-7.4.1 High-Resistance Measurement System Verification

Prior to connecting test coupons to the measurement system, connect each cable assembly to the resistor verification coupon (**Q-4.9**) inside the humidity chamber at ambient conditions and take a measurement. Rework and replace any cable that does not read within the tolerance value of the total measurement system (± 5 percent up to $10^{10} \Omega$, ± 10 percent between $10^{10} \Omega$ and $10^{11} \Omega$, and ± 20 percent above $10^{11} \Omega$).

NOTE — See **R-9** for information about electromagnetic shielding of cables and **R-10** for further information about connecting the verification coupon.

Q-7.4.2 Test Coupon Measurement Procedure

Q-7.4.2.1 After connecting coupons in accordance with **Q-7.1.1.1**, select environmental conditions a) or b), as appropriate.

- a) $40 \text{ °C} \pm 2 \text{ °C}$ with a relative humidity of (90 ± 3) percent; and
- b) $85 \text{ °C} \pm 2 \text{ °C}$ with a relative humidity of (85 ± 3) percent.

As an alternative to $40 \text{ °C} \pm 2 \text{ °C} / 90 \text{ percent} \pm 3 \text{ percent RH}$, it is acceptable to use $40 \text{ °C} \pm 2 \text{ °C} / 93 \text{ percent} \pm 3 \text{ percent RH}$. This shall be agreed between users and supplier prior to use. Using 93 percent RH can lead to different results when compared to using 90 percent RH. See **R-5** for guidance on which environmental conditions should be used and, **R-6** and **R-7** for information on specimen integrity during testing.

Q-7.4.2.2 Insert test coupons into the humidity chamber (**6.7**) and seal the chamber. Without bias applied, ramp from laboratory ambient conditions to $25 \text{ °C} \pm 2 \text{ °C}$ and (50 ± 3) percent RH and

dwell for 1 h.

Q-7.4.2.3 Verify the electrical system setup by taking a series of all SIR measurements at these specified ambient conditions. Because classification or ranking of sample performance by SIR at ambient is not appropriate for these test vehicles, clarity suggests that measurements need not be reported unless ‘shorts’ are observed and therefore the corresponding samples are deemed inappropriate for test.

Q-7.4.2.4 Increase the temperature to $40\text{ °C} \pm 2\text{ °C}$ or $85\text{ °C} \pm 2\text{ °C}$, depending on the flux chemistry being evaluated (*see M-5* for guidance on which environmental conditions should be used and **M-6** and **M-7** for information on specimen integrity during testing) while maintaining the humidity at (50 ± 3) percent RH and dwell at this temperature for 15 min. After this period, gradually increase, within 30 min, the relative humidity to (85 ± 3) percent RH or (90 ± 3) percent R.H depending on the flux chemistry being evaluated (*see R-5* for guidance on which environmental conditions should be used and **R-6** and **R-7** for information on specimen integrity during testing). Do not allow the temperature of the samples to drop below the dew point. This ramp-up should not exceed 3 h.

Q-7.4.2.5 Allow the specimens to come to equilibrium for at least one hour before applying the bias voltage to begin the test. If a salt solution and desiccator are used for humidity, specimens shall be held for 24 hours before beginning the test.

Q-7.4.2.6 If the alternative conditions of $40\text{ °C} \pm 2\text{ °C}$ and (93 ± 3) percent RH are being employed, the chamber shall be increased to (93 ± 3) percent RH rather than the (90 ± 3) percent RH referenced above. *See R-5.2* for additional details.

Q-7.4.2.7 The duration of testing shall be a minimum of 168 h at test conditions.

Q-7.4.3 *Measurements*

Apply bias 1 h after chamber stabilization at test conditions. Measurement and stress bias voltage shall be the same.

Measurements shall be made with test coupons in the chamber under the test conditions of temperature and humidity at not less than 20-minute intervals. To take these measurements, the stress bias voltage source shall be removed from the test coupon and the measurement voltage shall be applied. Unless a different voltage is agreed between user and supplier, the voltage for both stress and measurement shall be 5 V DC. *See R-5.3* for additional information on test voltages.

NOTE — *See R-8* for further information on the frequency of monitoring.

For the purpose of this standard and classification of flux, each comb pattern on each test specimen/test coupon shall be evaluated by the insulation resistance values at 24 h, 96 h and 168 h. The insulation resistance values of each comb pattern shall be greater than $10^8\ \Omega$. If the control coupon readings are less than $10^9\ \Omega$, a new set of test specimens shall be obtained and the entire test repeated. The reading at 24 h may fall below the required value provided that it recovers by

96 h.

Any reason for deleting values (for example scratches, condensation, bridged conductors, and outlying points) shall be noted. Deletion of results for more than two combs shall require the test to be repeated.

All specimens shall also be examined for other changes/observations given in **Q-8**.

At the end of the test exposure, remove electrical bias from all test patterns prior to temperature-humidity ramp-down initiation. After ramp-down, stabilize the chamber at 25 °C and 50 percent RH for 2 h and take out the specimens for evaluation in accordance with **Q-8**.

NOTE — Other methods like IPC, JIS, Bellcore are acceptable.

Q-7.5 Electrochemical Migration (ECM) Test

Extend SIR measurement (**Q-7.4**) for 500 hours (596 hours in total including the stabilization period of 96 hours) and measure the insulation resistance after 24 h, 96 h, 168 h and 500 h, after the placement of the test specimens in the temperature/humidity oven and after stabilization period of 96 hours at specific test temperature and humidity (*see P-9 and P-12.3* for details on the measurements of average insulation resistance).

At the end of the test exposure, remove electrical bias from all test patterns prior to temperature-humidity ramp-down initiation. After ramp-down, stabilize the chamber at 25 °C and 50 percent RH for 2 h and and take out the specimens for evaluation in accordance with **Q-8**.

NOTE — Other methods like IPC, JIS, Bellcore are acceptable.

Q-8 ASSESSMENT/EVALUATION FOR DENDRITE AND OTHER VISIBLE CHANGES

All specimens shall also be examined for other changes given in **Q-8**, under $\times 10$ to $\times 30$ microscope using backlighting within 24 h of completing the testing. If the coupons are to be held longer, they shall be placed in Kapak® or other non-contaminating container and stored in a desiccator. All the samples must be evaluated within seven days.

After conditioning, remove the specimens from the chamber and examine at $\times 10$ to $\times 30$ in light field and dark field (back light). Record the following:

- a) Presence of dendrites: yes/no;
- b) Maximum percent reduction of spacing: 0 percent for no dendrites, 1 percent to 100 percent for worst-case dendrite. Capture and record image of the worst case dendrites. If dendrite spans more than 20percent of the original spacing, this condition will constitute failure. It should be determined whether the dendritic growth is due to condensation from the chamber (*see R-6*);

- c) Presence of discoloration between conductors: yes/no; if yes, capture and record the image;
- d) Presence of water spots: yes/no; if yes, capture and record the image; and
- e) Presence of subsurface metal migration: yes/no; if yes, capture and record the image.

Q-9 PRECISION

An intralaboratory test equipment assessment shall be performed on all SIR test coupons prior to the execution of the SIR testing to verify that the repeatability of the test coupon is within the acceptable limits. The analysis shall measure the repeatability using the gauge r and R methodology specified in IS 15393 (Part 2)/ISO 5725-2.

The repeatability assessment shall consist of a minimum of five repeated measurements on a minimum of 12 test patterns.

The results shall report the standard deviation, repeatability, r, and the repeatability percentage of the specification for each of the test values being captured. The repeatability percentage shall be not greater than 10 percent of the specification range.

Q-10 TEST REPORT

The test report shall include, at least, the following information:

- a) Identification and preparation of the flux sample (*see Q-6.1*);
- b) Reference to this test method (that is Annex Q , IS 1921)
- c) Details of any post-soldering cleaning procedures used before coupon conditioning and measurement (*see Q-7.3*);
- d) Details of the solvent used for the solid flux sample, if appropriate (*see Q-6.1.1*);
- e) Qualification test report, which should be in accordance with Annex S;
- f) Individual charts or graphs showing the measured resistance (log ohms vs time) for each coupon and test pattern, or box plots for the data set;
- g) SIR results obtained for each pattern:
 - 1) After optional preconditioning, if applicable (*see Q-7.1.2*);
 - 2) At ambient conditions (*see Q-7.4.2.*); and
 - 3) All measurement values (*see Q-7.4.3*);
- h) Any unusual features noted during the test;
- j) Details of any operation not included in this document or regarded as optional;
- k) the environmental conditions used for the test, i.e. condition a) or b) in **Q-7.4.2.1**; and
- m) the date of the test.

ANNEX R
(Annex C)
(Informative)

GENERAL SIR TESTING GUIDANCE

R-1 TEST COUPONS

There are several names used in the industry, all of which can be equally applied. These include:

- a) test vehicle;
- b) test coupon; and
- c) test sample.

R-2 TEST COUPON DEVELOPMENT

It has been the practice for different test coupons to be used and that has led to confusion in respect to comparing test results. In addition, previous revisions of this and other test methods, have conflicting requirements in respect to the voltage gradient and test voltages to be used. To resolve this confusion, a comprehensive ‘round-robin’ research study was conducted that employed a new test coupon that includes test pattern characteristics of the following test coupons: IPC B24; Bellcore and IEC 61189-5 Method 5E01.

A full technical report IEC TR 61189-5-506 of this separate research study should be reviewed.

R-3 COUPON COUNT

A test coupon should be considered a sample count of 1. For example, an IPC B53 test coupon is a sample count of 1, even though there are 6 distinct test patterns and measurements.

R-4 DERIVED UNIT OF SIR

The derived unit of surface resistivity and its expression as ohm/square cannot be defined for this method or similar methodologies due to the non-linear response of the test coupons and the assumed nonhomogeneous concentration of ionic and non-ionic contaminants.

R-5 TEST CONDITIONS

R-5.1 General

Fluxes that contain more than a mass fraction of 1 percent organic acid activators, such as adipic acid, that volatilize significantly at 85 °C and less than a mass fraction of 5 percent rosin or modified-rosin resin should be tested at 40 °C and 90 percent RH. Fluxes that contain more than a mass fraction of 0.1 percent ionic halide should be tested at 85 °C and 85 percent RH.

CAUTION — Some weak organic acid-containing fluxes have volatile residues which can be driven off at higher test

temperatures than those experienced in environmental conditions.

R-5.2 90 PERCENT RH OR 93 PERCENT RH

IEC 60068-2-78 includes a set of damp heat conditions of $40\text{ }^{\circ}\text{C} \pm 2\text{ }^{\circ}\text{C}$ and (93 ± 3) percent RH, whereas SIR testing has traditionally employed the same temperature but the lower humidity value of 90 percent RH \pm 3 percent RH. The historical reason for this difference is that with the 3 percent tolerance applied to 93 percent RH, condensation would typically occur at the high end of the tolerance (for example 95 percent RH to 96 percent RH) and this in turn would lead to “rain” in the chamber which could in turn fall on the coupons, something that shall be avoided in this SIR test. Based on this, the default humidity value for SIR testing in the industry became (90 ± 3) percent RH. This 90 percent RH value continues to be referenced in the industry and is the default value provided in this test method for no-clean fluxes. With the development of some modern damp-heat chambers, it is now possible to employ (93 ± 3) percent RH without creating “rain” in the chamber and as such, this humidity option has been permitted in this test method as an alternative to (90 ± 3) percent RH, providing it is first agreed between user and supplier. Without this agreement, the 90 percent RH value is to be used for no-clean flux chemistries. User and supplier should be aware that 93 percent RH may lead to different results to those seen when using 90 percent RH and as such direct comparisons of values produced using these two different humidity levels should be conducted with caution.

R-5.3 VOLTAGE

The stress and test voltage in this document is defaulted to 5 V DC but as it is designed to cover many different use applications, the option has been provided for the user and supplier to agree to employ different stress and test voltages. 5V DC is the test voltage used in historical test methods, such as IPC-TM-650 2.6.3.7, and may be useful to those trying to compare results from that test method and this test method. The key thing is to understand the end-use requirements for the product being assessed, and employ a suitable stress and test voltage for that application. Although, it should be noted that the IPC B-53 test vehicle has not been designed for testing above 100 V DC. For additional considerations on test voltage and voltage gradient, please consult IEC TR 61189-5-506.

R-6 RISK OF CONDENSATION

If condensation occurs on the test coupons in the environmental chamber while the coupons are under voltage, dendritic growth or filament formation can occur. Dendritic growth or filament formation can be caused by a lack of sufficient control of the humidification of the oven. Water spotting can also be observed in some ovens where the airflow in the chamber is from back to front. In this case, water condensation on the cooler oven window can be blown around the oven as microdroplets, which deposit on the test coupon surfaces and cause dendritic growth if the spots bridge the distance between electrified conductors. Both of these conditions shall be eliminated for proper testing.

R-7 PRECAUTIONS

It is recommended that a drip shield be placed over and/or around the test samples to prevent water droplets from dropping from the chamber ceiling or from the chamber doors on to the energized test samples. However, the drip shield should also not interfere with good airflow around the test samples, which can require innovative shielding approaches.

R-8 FREQUENCY OF MONITORING

During SIR testing resistance values can change rapidly over a period of minutes. These are often transitory in nature with SIR values often recovering by the end of the test. Such a drop in SIR can constitute failure in real product. Modern frequent sampling instruments can monitor up to 128 SIR patterns in less than 20 min and so capture this type of short-lived event. It is recommended that measurement readings be taken as frequently as possible to detect rapid changes in SIR.

R-9 ELECTROMAGNETIC SHIELDING

For consistent and repeatable results, it is important that all cabling carrying test signals be encased in an electromagnetic shield. Most often, this is a metallic foil or braid material. Since SIR measurement often deals with picoamperes of current or less, EMC and other stray electrical fields can unduly affect the test signals. Encasing the signal lines with an earthed metal dramatically reduces currents due to EMC and other electrical noise. It is not necessary to individually shield each line, such as in coaxial cabling, but separating voltage supply lines and current-return lines is recommended. A single EMC shield can be used to encase all current-return lines.

R-10 CONNECTIONS

During the actual execution of the test programme, the verification coupon should be connected to the high-resistance measurement system via an external connector or connection. The test coupon can then be periodically measured to verify that the high-resistance measurement system is under proper operating conditions if anomalous readings are observed.

R-11 ADVANTAGES AND DISADVANTAGES OF USING CONNECTORS AS PART OF THE MEASUREMENT SYSTEM

R-11.1 Advantages

- a) Ease of use. Preparation for an SIR test is fairly easy; simply plug the coupon into the edge card connector;
- b) Connector assemblies can be made in higher volumes during slack time;
- c) No hand soldering is done, therefore no additional flux residues will contact the test patterns;
- d) Handling is kept to a minimum; and
- e) The orientation of the best coupon can be held parallel to the chamber airflow.

R-11.2 Disadvantages

- a) Depending on the materials of construction, the connectors can have leakage currents resulting in a 0.5 decade drop (or higher) at $10^{12} \Omega$ compared with hard wired samples. Proper connector design and choice of highly insulating materials (e.g. PTFE) can minimize this effect;
- b) The connectors should be verified before each use and monitored with time to determine if the resin system has aged, resulting in greater leakage currents;
- c) The spring-loaded contacts will wear with each use. Solder bulges on the test coupons increase the wear. Examining the contact fingers on test coupons as coupons are withdrawn from the test can give an indication of adequate contact (look for scratches);
- d) The cover metallization on the spring-loaded contacts will wear, especially if soft gold. This wear can result in dissimilar metals in contact and an increase in contact resistance; and
- e) Potential for entrapment of moisture.

ANNEX S
(Clauses P-7.4.2, Q-7.3.2 and Q-10)
(Informative)

**SURFACE INSULATION RESISTANCE COMB TEST AND ELECTROCHEMICAL
MIGRATION TEST OF FLUX RESIDUES — QUALIFICATION TEST REPORT**

S-1 OVERALL ASSESSMENT

S-1.1 Material Identification

ID Number:	
Flux classification (flux type):	
Flux form: ^a	
Manufacturer's identity:	
Manufacturer's batch number:	
Date of manufacturer:	
Original use by date:	
Solder alloy (if used):	
^a Examples include liquid, paste, cored wire, preform.	

S-1.2 Processing Parameters

Reflow method:	
Maximum preheat temperature (°C):	
Time above liquidus or solder contact time:	
Cleaning method, materials and parameters:	

S-1.3 Testing Parameters

Date original qualification tests complete:	
Tested by:	
Interconnect attachment method: ^a	
Chamber within stated tolerances?	
Test anomalies noted:	
Number of patterns tested:	
Number and identity of reworked patterns:	
Preconditioning time:	
Test environment:	
^a Refers to method used to interconnect coupons: hard wire solder vs connectors or dedicated fixtures.	

S-2 Visual examination

Parameter	Observations
Dendritic growth?	
Corrosion?	
Other visual effects:	

Material identification number: _____

S-3 SUMMARY: MEASUREMENT RESULT

All measurement values are listed in log ohms (base 10 logarithm of the measured resistance). **Requirements:** no value may fall under 100 megohms (8.0 log ohms) at any time during the test. SIR measurements should be provided in an appropriate graph or table.

ANNEX T

(Foreword, Clause 7.4 and Annex B)

DETERMINATION OF ACID VALUE BY POTENTIOMETRIC AND VISUAL TITRATION METHODS

T-1 OBJECTIVE OF THE TEST METHOD

This test method specifies two methods for the determination of the acid value of a flux types L, M or H having RO, RE and OR flux compositions.

Method A is a potentiometric titration method and is to be considered as the referee method.

Method B is an alternative, visual end-point, titration method.

T-2 TEST SPECIMEN

A minimum of 2.0 g of liquid flux, 10 g of solder paste, 150 g of cored wire or 10 g of solder preforms.

T-3 METHOD A: POTENTIOMETRIC TITRATION METHOD

T-3.1 Principle

A prepared, weighed sample of the flux is dissolved in a suitable solvent. The resulting solution is titrated with standard tetrabutyl ammonium hydroxide solution, using a glass electrode, the pH or mV readings being recorded simultaneously. From the graph of volume of titrant against pH or mV readings, the point of inflexion is determined, from which the acid value is calculated.

T-3.2 Reagents

Use only reagents of recognized analytical quality and only distilled or deionized, water.

T-3.2.1 *Tetrabutyl Ammonium Hydroxide* $[(CH_3CH_2CH_2CH_2)_4NOH]$ 0.1 M (0.1 mol/L).

Use a commercially available standard solution of 0.1 mol/L tetrabutyl ammonium hydroxide solution or one prepared from a commercially available concentrated standard solution (of the concentration higher than 0.1 mol/L) by dilution with propan-2-ol, anhydrous (*see T-3.2.2*)—and standardize this solution against an accurately weighed amount of benzoic acid about 0.5 g, dissolved in dimethylformamide, previously neutralised to thymol blue.

T-3.2.2 Propan-2-ol $[(CH_3)_2CHOH]$, neutralized with tetrabutyl ammonium hydroxide solution (**T-3.2.1**) to a faint pink colour, using phenolphthalein as indicator.

T-3.2.3 Ethanol (C_2H_5OH), anhydrous, neutralized with tetrabutyl ammonium hydroxide solution (**T-3.2.1**) to a faint pink colour using phenolphthalein as indicator.

T-3.2.4 Toluene ($C_6H_5CH_3$), neutralized with tetrabutyl ammonium hydroxide solution (**T-3.2.1**) to a faint pink colour using phenolphthalein as indicator.

T-3.2.5 Ethanol/toluene mixture, made by mixing equal volumes of the anhydrous ethanol (**T-3.2.3**) and toluene (**T-3.2.4**).

T-3.3 Apparatus

Usual laboratory apparatus and, in particular, the following.

T-3.3.1 Millivoltmeter or pH meter.

T-3.3.2 Glass electrode.

T-3.3.3 Saturated calomel, or silver chloride/silver, electrode.

T-3.3.4 Magnetic, or mechanical, stirrer, with variable speed drive.

T-3.3.5 Automated titration system with evaluating processor unit.

T-3.4 Procedure

T-3.4.1 *General*

T-3.4.1.1 Use the procedure specified in Annex A to determine the mass of the flux and obtain the 25 percent by mass solution of flux in reagent grade 2-propanol(**T-3.2.2**), Ethanol (**T-3.2.3**), Toluene(**T-3.2.4**), the ethanol/toluene mixture (**T-3.2.5**) or any other solvent recommended by the supplier in which the flux is completely soluble for testing purpose.

T-3.4.1.2 Carry out the following procedure, in triplicate, on the flux sample.

T-3.4.1.3 Weigh, to the nearest 0.001 g, 2 to 5 g of the liquid flux sample, taking steps to prevent loss of volatile matter during the weighing. The larger size (≈ 5 g) sample is required for very low solids fluxes. Transfer the weighed sample to a 250 ml low form beaker.

T-3.4.1.4 Dilute the sample to 100 ml with propan-2-ol (**T-3.2.2**), Ethanol (**T-3.2.3**), toluene (**T-3.2.4**), ethanol/toluene mixture (**T-3.2.5**) or any other solvent recommended by the manufacturer according to the solubility characteristics of the flux. Cover with a watch glass and dissolve the flux by gentle agitation.

T-3.4.2 *Manual Procedure*

T-3.4.2.1 Place the beaker on the stand of the titration assembly with the electrodes, stirrer and burette in position. Adjust the speed of the stirrer to give vigorous stirring without splashing. Titrate

with the 0.1 M tetrabutyl ammonium hydroxide solution (T-3.2.1) adding 1 ml portions and recording the pH, or mV meter readings after each addition. As the endpoint is approached, reduce the additions of titrant to 0.1 ml and continue titrating past the endpoint.

T-3.4.2.2 Plot the pH, or potential values against the volume of titrant added to obtain the titration curve. The point of inflexion of the curve corresponds to the end-point of the titration.

NOTE — The point of inflexion of the curve can conveniently be determined by using the derivative curve.

T-3.4.2.2.3 Carry out a blank determination, using all reagents, for comparison purposes.

T-3.4.3 *Automated Procedure*

T-3.4.3.1 Details of the automated procedure must be in accordance with the manual of used titration system.

T-3.4.3.2 Place the beaker on the stand of the titration assembly and bring other titration equipment in position as defined in the manual. Adjust the speed of the stirrer to give vigorous stirring without splashing. Before titration starts, several parameters shall be entered into the evaluation unit for calculation and identification of the test sample.

T-3.4.3.3 Start the automated titration system. The titration curve is plotted automatically.

T-3.4.3.4 If there are no other requirements in the manual, carry out a blank determination, using all reagents, for comparison purposes.

T-3.5 Calculation of Results

The acid value is expressed in milligrams of potassium hydroxide per gram of non-volatile matter, regardless of the alkali used to perform the titration. The acid value (expressed in milligrams of potassium hydroxide per gram of non-volatile matter) is given by formula below

$$\frac{56.11 \times V \times M}{m \times S}$$

where

V is the volume, in millilitres, of alkali used (tetrabutyl ammonium hydroxide for Method A and use potassium hydroxide for method B), minus the volume needed to titrate the blank;

M is the molarity of the tetrabutyl ammonium hydroxide solution/potassium hydroxide (T-3.2.1);

m is the mass, in grams, of the sample taken;

S is the percentage non-volatile matter content of the sample, determined as described in Annex L (for solid flux samples, $S = 100$).

The acid value of the flux under test is calculated as the mean of the results obtained of the three test samples.

At the end of an automatic titration the evaluation unit automatically calculates the results. Some units plot the titration curve, too.

T-4 METHOD B — TITRATION METHOD WITH VISUAL END-POINT

T-4.1 Principle

A prepared, weighed sample of the flux is dissolved in neutralized propan-2-ol, ethanol, toluene, or an ethanol/ toluene mixture or any other solvent recommended by the supplier. The solution is then titrated with standard potassium hydroxide solution and the acid value is calculated.

T-4.2 Reagents

Use only reagents of recognized analytical quality and only distilled, or deionized water.

T-4.2.1 Ethanol, anhydrous, neutralized with potassium hydroxide, 0.1 mol/L in alcohol (**T-4.2.5**), to a faint pink colour using phenolphthalein as indicator.

T-4.2.2 Toluene, neutralized with potassium hydroxide, 0.1 mol/L in alcohol (**T-4.2.5**), to a faint pink colour using phenolphthalein as indicator.

T-4.2.3 Ethanol/toluene mixture, made by mixing equal volumes of the anhydrous ethanol (**T-4.2.1**) and toluene (**T-4.2.2**).

T-4.2.4 Propan-2-ol, neutralized with potassium hydroxide, 0.1 mol/l in alcohol (**T-4.2.5**), to a faint pink colour using phenolphthalein as indicator.

T-4.2.5 Potassium hydroxide solution, 0.1 mol/L in alcohol.

Use a commercially available standard solution or one prepared from a commercially available concentrated standard solution by dilution with ethanol (**T-4.2.1**). Alternatively, prepare a 0.1 mol/L potassium hydroxide solution by dissolving $3 \text{ g} \pm 0.1 \text{ g}$ potassium hydroxide (KOH) in 500 ml of ethanol (**T-4.2.1**) and standardize this solution against an accurately weighed amount of benzoic acid (about 0.5 g) dissolved in ethanol (**T-4.2.1**).

T-4.2.6 Phenolphthalein indicator solution. Add 1 g of phenolphthalein to approximately 50 ml methanol and mix. When dissolved, dilute to 100 ml with methanol and mix.

T-4.3 Apparatus

Ordinary laboratory apparatus is required.

T-4.4 Procedure

Use the procedure specified in Annex A to determine the mass of the flux and obtain the 25 percent by mass solution of flux in 2-propanol(T-4.2.4), Ethanol (T-4.2.1), Toluene(T-4.2.2), the ethanol/toluene mixture (T-4.2.3) or any other solvent recommended by the supplier in which the flux is completely soluble.

Carry out the following procedure in triplicate on the flux sample. Weigh, to the nearest 0.001 g, sufficient of the liquid flux sample correspond to approximately 1 g of non-volatile matter (*see* Annex L), taking steps to prevent loss of volatile matter during the weighing. Transfer the weighed sample to a suitable flask or beaker and add 100 ml of the selected solvent. Stir until the sample has dissolved as completely as possible. Do not heat.

Add 3 drops of phenolphthalein (T-4.2.6) and titrate with the potassium hydroxide solution (T-4.2.5) until a faint pink colour persists throughout the titrated solution for 15 s.

Carry out a blank determination, using all reagents, for comparison purposes.

T-4.5 Calculation of Results

The acid value of the sample, expressed in milligrams of potassium hydroxide per gram of non-volatile matter, is given by mathematical formula given in T-3.5.

The acid value of the flux under test is calculated as the mean of the results obtained of the three test samples.

ANNEX U
(Foreword)

GRADES COVERED IN THE SECOND REVISION OF THIS INDIAN STANDARD

Table 13 Chemical Composition of Solders Used for Flux Cored Solder Wires
(Annex U)

Sl No.	Grade	Alloying Element, Percent		Impurities, Percent, <i>Max</i>			
		Sn (3)	Pb (4)	Sb (5)	Cu (6)	As (7)	Fe (8)
i)	60	60 ± 0.5					
ii)	50	50 ± 0.5					
iii)	40	40 ± 0.5	Remainder	0.2	0.05	0.05	0.02
iv)	35	35 ± 0.5					
v)	20	20 ± 0.5					

NOTE — Total of other impurities namely, Al, Zn or Cd shall be limited to 0.08 percent as their presence is harmful.

ANNEX V
(Foreword)

GUIDANCE TEST REPORT FOR SOLID AND FLUX CORED SOLDER WIRE

Manufacturers Identification:		Manufacturer's Batch Number:	
Date of Manufacture:		Original Expiration Date:	
Alloy Designation:		Solder Form: Solid [] Flux Cored Wire []	
		Diameter: _____	
		Overall Result : Pass/Fail	
Inspection and Test Results			
Inspections	Inspection Method Clause	Requirement Clause of IS 1921	Result/Descriptive Results
Material	–	<i>Clause 5</i>	
Alloy Composition	Standard Analytical Procedures (Spark OES, ICP-OES, AAS, IS 998 (various parts) etc.)	<i>Clause 6.2</i>	
Dimensions	Annex H	<i>Clause 8</i>	
Solder Core	7.1.1.2 (Visual)	<i>Clause 7.1.1</i>	
Flux Percentage	Annex E	<i>Clause 7.3</i>	
Flux Classification	Annex D	<i>Clause 7.2 and Annex D</i>	
Flux Residue Dryness	Annex G	<i>Clause 7.5</i>	
Packaging and Labelling/Marking	Visual	<i>Clauses 12 and 13</i>	

NOTES

1 An example of inspection report format for soldering flux for its classification can be found in Annex S.

2 For non-fluxed solder wire only Material, Dimensions, and Packaging and Labelling/Marking inspection results are to be reported.

ANNEX W
(Foreword)

COMMITTEE COMPOSITION

Ores and Feed Stock for Non-Ferrous (Excluding Aluminium and Copper) Industry, their Metals/Alloys
and Products Sectional Committee, MTD 09

<i>Organization</i>	<i>Representative(s)</i>
CSIR -National Metallurgical Laboratory, Jamshedpur	DR ABHILASH (Chairperson)
Arya Alloys Private Limited, New Delhi	SHRI AMRENDRA K. JHA
BT Solders Private Limited, Bengaluru	SHRI ANANT TOSHNIWAL SHRI S. RAMESH (<i>Alternate</i>) DR. DHRUVA KUMAR SINGH
Bhabha Atomic Research Centre, Mumbai	DR. BHASKAR PAUL (<i>Alternate</i>) SHRI RAJAK SYED (<i>Young Professional</i>)
Bharat Electronics Limited, Bengaluru	SHRI SHREEDHAR NADIGER SHRI AWADESH KUMAR (<i>Alternate</i>)
Bombay Non Ferrous Metals Association Limited, Mumbai	SHRI SANDEEP VAKHARIA
CSIR — Central Electrochemical Research Institute, Karaikudi	DR. C. NAVEEN KUMAR DR. M.JAYA KUMAR (<i>Alternate I</i>) DR. N. RAJASEKARAN (<i>Alternate II</i>)
CSIR -National Metallurgical Laboratory, Jamshedpur	DR. PRATIMA MESHARAM (<i>Alternate</i>)
Chakradhar Chemicals Private Limited, Muzaffarnagar	SHRI NEERAJ KEDIA
Directorate General of Aeronautical Quality Assurance, Ministry of Defence, New Delhi	DR NEERAJ CHAURASIA SHRI MAHENDRA KUMAR GUPTA (<i>Alternate</i>)
Directorate General of Quality Assurance, Ministry of Defence, Ichapur	SHRI A K VERMA SHRI KARTIKEY SHARMA (<i>Alternate</i>)
Eveready Industries India Limited, Kolkata	SHRI G. PRAHALATHAN SHRI SENTHIL R. PANDIAN (<i>Alternate</i>)
Exide Industries Limited, Kolkata	DR. SAGAR SENGUPTA SHRI SURAJIT CHANDRA DEB (<i>Alternate</i>)
Hindustan Zinc Limited, Udaipur	SHRI HIMMAT HADIYA SMT MANINEE MANASMITA NAYAK (<i>Alternate</i>)
Indian Bureau of Mines, Nagpur	DR D. R. KANUNGO DR JYOTI SHRIVASTAVA (<i>Alternate</i>)
Indian Institute of Technology , Roorkee	PROF NIKHIL DHAWAN PROF UJJWAL PRAKASH (<i>Alternate</i>)
Indian Lead Zinc Development Association, New Delhi	SHRI K. SRIDHAR SHRI L. PUGAZHENTHY (<i>Alternate</i>)

Indian Rare Earths Limited, Mumbai	SHRI D. SINGH DR B. R. MISHRA (<i>Alternate</i>)
IZA India (International Zinc Association), New Delhi	DR. RAHUL SHARMA SHRI KENNETH DE SOUZA (<i>Alternate</i>)
Indiana Gratings Private Limited, Pune	SHRI SANDESH A. NANNAWARE SHRI SANJAY BHARNE
Kothari Metsol Private Limited, Pune	SHRI VISHAL KOTHARI
MSME Testing Center, New Delhi	SHRI D. D. GAJBHIYE SHRI G.PRASAD (<i>Alternate</i>) SHRI GURURAJA U. V SMT ASHMITA PATRA BANERJEE (<i>Alternate</i>) SHRI VAMSI KRISHNA PARIMI (<i>Young Professional</i>)
Mishra Dhatu Nigam Limited, Hyderabad	DR SANKARARAMAN SANKARANARAYANAN
National Institute of Technology, Tiruchirapalli	SHRI G. VENKATESWARA RAO
National Mineral Development Corporation, Hyderabad	SHRI D. RAJAGOPALA RAO SHRI SUHAS PINGALE (<i>Alternate</i>)
National Test House, Kolkata	SHRI V. P. DESHMUKH DR A. GOURAV RAO (<i>Alternate</i>)
Naval Materials Research Laboratory, Thane	SHRI K.H.K SRINIVAS SHRI S. MAHESH BABU (<i>Alternate</i>)
Nile Limited, Hyderabad	SHRI VIJAY KAUSHIK SHRI G SAMYUKTHA (<i>Alternate</i>)
Nuclear Fuel Complex, Hyderabad	SHRI NITIN SALVI SHRI AMIT SANGAI
Phoenix Industries Limited, Dadra and Nagar Haweli	SHRI K. N. M. RAO DR SATISH KUMAR (<i>Alternate</i>)
Power Grid Corporation of India, Gurugram	SHRI R. K. VIJAY SHRI ANOOP SINGH DAGUR (<i>Alternate</i>)
Research Designs and Standards Organization (RDSO), Lucknow	SHRI V. K. DWIVEDI SHRI SANDEEP GUPTA (<i>Alternate</i>)
RITES Limited, Gurugram	SHRI SHASHANK JAIN SHRI ARUN GUPTA (<i>Alternate</i>) SHRI TARUSH JAIN (<i>Young Professional</i>)
Saru Smelting Private Limited, Meerut	SHRI VIVEK NORONHA SHRI VINOD NORONHA (<i>Alternate</i>)
Southern Metals & Alloys Private Limited, Mumbai	DR. SOURAJYOTI DEY SHRI SUBRATA SADHU (<i>Alternate</i>)
The Tinsplate Company of India Limited, Jamshedpur	SHRI SANJIV MAINI, SCIENTIST 'F' AND Senior DIRECTOR AND HEAD (MTD) [REPRESENTING DIRECTOR GENERAL (<i>Ex-officio</i>)]
BIS Directorate General	

Member Secretary
SHRI SAAQIB RAAHI
Scientist 'C'/Deputy Director (MTD), BIS

Panel for Revision of Indian Standard on Flux Cored Solder Wire IS 1921 : 2005, MTD09/P6

<i>Organization</i>	<i>Representative(s)</i>
Macdermid Alpha Electronics Solutions India Private Limited, Chennai	SHRI PRASANNA SOMASUNDARAM (<i>Convener</i>)
BT Solders Private Limited, Bengaluru	SHRI S. RAMESH
Hi Flo Solders, Private Limited, Chennai	SHRI FRANCIS JOSEPH
Khanna Traders and Engineers, New Delhi	DR S.K. KHANNA
Saru Smelting Private Limited, Pune	SHRI ARUN GUPTA
Persang Alloy Industries Private Limited, Vadodara	SHRI AADIL J. BAVAADAM
Kothari Metsol Private Limited, Pune	SHRI VISHAL KOTHARI

Bibliography

- [1] ISO 9453:2020 Soft solder alloys — Chemical compositions and forms. International Organization for Standardization.
- [2] ISO/DIS 12224-1 Solder wire, solid and flux cored — Specification and test methods — Part 1: Classification and performance requirements. International Organization for Standardization.
- [3] ISO 12224-2 :2024 Solder wire, solid and flux cored — Specification and test methods — Part 2 : Determination of flux content. International Organization for Standardization
- [2] ISO 9454-1:2016 Soft soldering fluxes — Classification and requirements Part 1: Classification, labelling and packaging. International Organization for Standardization.
- [3] ISO 9454-2:2016 Soft soldering fluxes — Classification and requirements Part 2: Performance requirements. International Organization for Standardization.
- [4] IEC 61190-1-1:2002 Attachment materials for electronic assembly - Part 1-1: Requirements for soldering fluxes for high-quality interconnections in electronics assembly. International Electrotechnical Commission
- [5] IEC 61190-1-3:2017 Attachment materials for electronic assembly - Part 1-3: Requirements for electronic grade solder alloys and fluxed and non-fluxed solid solder for electronic soldering applications. International Electrotechnical Commission
- [6] IEC 61189-5-2: 2015 Test methods for electrical materials, printed boards and other interconnection structures and assemblies - Part 5-2: General test methods for materials and assemblies - Soldering flux for printed board assemblies. International Electrotechnical Commission
- [8] IEC 61189-5-4:2015 Test methods for electrical materials, printed boards and other interconnection structures and assemblies - Part 5-4: General test methods for materials and assemblies - Solder alloys and fluxed and non-fluxed solid wire for printed board assemblies. International Electrotechnical Commission
- [9] IEC 61189- 5-501:2021 Test methods for electrical materials, printed boards and other interconnection structures and assemblies - Part 5-501: General test methods for materials and assemblies - Surface insulation resistance (SIR) testing of solder fluxes. International Electrotechnical Commission
- [10] IEC TR 61189-5-506:2019 Test methods for electrical materials, printed boards and other interconnection structures and assemblies - Part 5-506: General test methods for materials and assemblies - An intercomparison evaluation to implement the use of fine-pitch test structures for surface insulation resistance (SIR) testing of solder fluxes in accordance with IEC 61189-5-501. International Electrotechnical Commission
- [11] JIS Z 3197 : 2021 Test methods for soldering fluxes. Japanese Standards Association (JSA)
- [12] JIS Z 3283 : 2017 Resin flux cored solders. Japanese Standards Association (JSA)
- [13] JIS Z 3282 : 2017 Soft solders -- Chemical compositions and forms. Japanese Standards Association (JSA)
- [14] IPC J STD 004C (September 2022) Requirements for Soldering Fluxes. IPC International, USA.
- [15] IPC J STD 006 C (July 2013) Requirements for Electronic Grade Solder Alloys and Fluxed and Non-Fluxed Solid Solders for Electronic Soldering Applications. IPC International, USA.

- [16] IPC TM 650 Test Method Manual. Available from <https://www.ipc.org/test-methods>
- [17] IPC 9201A (August 2007) Surface Insulation Resistance Handbook. IPC International, USA.
- [18] Jasbir Bath, Gordon Clark, Tim Jensen, Renee Michalkiewicz and Brian Toleno; A Review of Test Methods and Classifications for Halogen-Free Soldering Materials published in the 2011 IPC, APEX conference proceedings'. Available from https://www.ipc.org/sites/default/files/test_methods_docs/TMpercent202.5.5.14.pdf
- [19] Peter Burton, Peter Footner, David Prichard Brian Richards and Christopher Hunt; Surface Insulation Resistance Measurements A Review of the Significance and Sensitivity of the Various SIR Parameters. Available from <https://eprintspublications.npl.co.uk/571/1/CMMT48.pdf>
- [20] EUROPEAN UNION. Directive 2011/65/EU of the European Parliament and of the Council of 8 June 2011 on the restriction of the use of certain hazardous substances (RoHS) in electrical and electronic equipment, Available from <https://eur-lex.europa.eu/legal-content/EN/TXT/?uri=CELEX:32011L0065>
- [21] INDIA. MINISTRY OF ENVIRONMENT, FOREST AND CLIMATE CHANGE. E-Waste (Management) Rules, 2022. Available from <https://cpcb.nic.in/rules-6/>