

BUREAU OF INDIAN STANDARDS

DRAFT FOR COMMENTS ONLY

(Not to be reproduced without permission of BIS
Or used as an Indian Standard)

Draft Indian Standard

**PLASTIC FEEDING AND DRINKING CONTAINERS, ACCESSORIES
AND CUTLERIES FOR INFANT AND CHILD USE — SPECIFICATION**

(ICS No. 83.08; 55.100)

Plastics Packaging Sectional Committee,
PCD 21

Last date for receipt of comment is
19 April 2023

FOREWORD

(Formal clause to be added later)

1 SCOPE

1.1 This standard prescribes the requirements, methods of sampling, safety aspects and test method for feeding and drinking container and their accessories.

1.2 This standard does not cover feeding bottles and teats for feeding bottles. These products are covered by IS 14625 and IS 3565 respectively.

2 REFERENCES

The following standards contain provisions which through reference in this text constitute provisions of this standard. At the time of publication, the editions indicated were valid. All standards are subject to revisions, and parties to agreements based on this standard are encouraged to investigate the possibility of applying the most recent editions of the standards indicated below.

IS No.	Title
IS 249 : 2022	Sodium bichromate, technical — Specification (<i>fourth revision</i>)
IS 266 : 1993	Sulphuric acid — Specification (<i>third revision</i>)
IS 1699 : 1995	Methods of sampling and test for food colours (<i>second revision</i>)
IS 2798: 1998	Methods of test for plastics containers (<i>first revision</i>)
IS 3025	Methods of sampling and test (physical and chemical) for water and waste water
Part 37 : 2022	Arsenic (<i>second revision</i>)
Part 41 : 1992	Cadmium (<i>first revision</i>)
Part 47 : 1994	Lead (<i>first revision</i>)
Part 48 : 1994	Mercury (<i>first revision</i>)
Part 52 : 2003	Chromium (<i>first revision</i>)

Part 56 : 2003	Selenium (<i>first revision</i>)
IS 3565 : 2018	Teats for feeding bottles — Specification (<i>first revision</i>)
IS 4905 : 2015 / ISO 24153 : 2009	Random sampling and randomization procedures (<i>first revision</i>)
IS 7019 : 1998	Glossary of terms in plastics and flexible packaging, excluding paper (<i>second revision</i>)
IS 8747: 1977	Methods of tests for environmental stress - crack resistance of blow moulded polyethylene containers
IS 9845: 1998	Determination of overall migration of constituents of plastics materials and articles intended to come in contact with foodstuffs — Methods of analysis (<i>second revision</i>)
IS 10910 : 1984	Specification for polypropylene and its copolymers for its safe use in contact with foodstuffs, pharmaceuticals and drinking water
IS 13360 (Part 9/Sec 5) : 1999	Plastics — Methods of testing : Part 9 Optical properties, Section 5 Determination of haze and luminous transmittance of transparent plastics
IS 14534 : 2016	Plastics — Guidelines for the recovery and recycling of plastics waste (<i>first revision</i>)
IS 14625:2015	Plastic feeding bottles (<i>first revision</i>)
IS 15303:2003	Determination of Antimony, Iron and Selenium in water by electrothermal atomic absorption spectrometric method
IS 15495 : 2020	Printing ink for food packaging — Code of practice (<i>first revision</i>)
IS 13360 (Part 9 / Sec 5) : 1999 / ASTM D 1003	Standard test method for haze and luminous transmittance of transparent plastics

3 TERMINOLOGY

For the purpose of this standard, the definitions given in IS 1382, IS 7019 and the following shall apply:

3.1 Air Vent — Component of an anti-colic device that has an opening that allows air to circulate.

3.2 Bowls — Round, square or any other shaped container, opened on top and that holds food, liquid, juice, soups for child.

3.3 Brimful Capacity — Volume of water or liquid required to fill the Container completely to brim level at 27 ± 2 °C.

3.4 Container with Breast Pump — Pump (manual or electrically operated) for extracting the milk from the breast through the nipple and attached to a container for drinking of breast milk by the child.

3.5 Breast Shield — Nipple-shaped sheath worn over the areola and nipple of the breast during breastfeeding.

3.6 Container — Capable of holding food either semi-solid, liquid for feeding or drinking purpose and it may be in the form of a bottle, tumbler, cups, or mugs.

3.7 Clip — Component designed to assist the attachment of a container on to garments.

3.8 Cord or Loop — Flexible component designed to assist the handling of a container.

3.9 Drinking Tumbler / Mugs / Cups — Container other than a feeding container or feeding bag capable of holding a fluid intended for feeding a child. Drinking cups are also known as “beakers”.

3.10 Double-Walled Insulated Sippy Cup — Container with insulated double wall, used for the drinking of fluid by the child.

3.11 Drinking Accessory — Device fitted to a container which permits a child to obtain fluid from it.

3.12 Drinking Glass — Container for holding liquids while drinking by the child.

3.13 Drinking Spout — Elastic/non-elastic drinking accessory other than a straw.

3.14 Feeding Container — Container capable of holding fluid with or without a graduated scale suitable for visual measurement and is intended for feeding a child through a suitable drinking accessory.

3.15 Feeding Spoon — Drinking accessory when assembled for its intended use on a Container.

3.16 Fresh Food Feeder — Perforated device which allows babies to chew, suck and taste the extract (fruit juice, fruit pulp, vegetables etc.) coming through without any kind of risk of choking.

3.17 Gravity / Weight Ball — A gravity / weight ball at the end of the straw helps the baby to easily drink while lying down.

3.18 Graduations — Markings indicating the volume of fluid within the container, numbered or unnumbered.

3.19 Handle — Component designed to assist the handling of a container during drinking.

3.19.1 Single-Side Handle — Handle at one side for holding while drinking by the child.

3.19.2 Double-Side Handle — Handle on both sides for holding while drinking by the child.

3.20 Locking Ring — A component used to secure a drinking accessory to a container.

3.21 Matched Components — Components that are intended to be used together whilst feeding a child.

3.22 Medicine Feeder — A silicon bulb and syringe-type container work together to push medicine through the bulb directly in babies' mouth. A medicine dispenser for babies and toddlers.

3.23 Nominal Capacity — Volume of milk / fluid normally expected to be filled in the Containers at 27 ± 2 °C.

3.24 Numbered Graduations — Markings indicating the volume of fluid within the drinking equipment.

3.25 Outer Packaging — Any packaging used for storage of the product by a retailer, not including the packaging intended for the consumer.

3.26 Protective Cover — Component to cover a drinking accessory.

3.26.1 Detachable Protective Cover — Cover or parts of it, intended to be detached when drinking or cleaning. After being detached, they can be reassembled in their original state.

3.26.2 Permanent Protective Cover — Cover or parts of it intended to stay attached to the product during use/drinking. It can only be detached by using a tool or force and is not intended to be reassembled later.

3.27 Plate — Flat dish from which food is served or from which food is eaten.

3.28 Protruding Part — Drinking accessory when assembled for its intended use on a container.

3.29 Push-Pull Valve — Drinking accessory equipped with a valve designed to be manually operated by a push-pull, twist, or similar action. A push-pull valve is also known as a “sports cup spout”.

3.30 Pipe — Component of drinking accessories where the valve with an internal vent or hole is fitted for the flow of air to facilitate drinking of liquid food easily by the child.

3.31 Re-Usable Product — Component intended to be used again after first use.

3.32 Sealing Disc — Component used to create a seal between the container and the locking ring.

3.33 Spoon and Fork — Accessory for eating food.

3.34 Straw — Cylindrical hollow tube through which fluid is sucked.

3.35 Sippy Straw Bottle — Feeding or drinking bottle with straw for sipping liquids, juice.

3.36 Sippy Spout Bottle — Feeding or drinking bottle with a silicone spout for feeding toddlers.

3.37 Sling (Strap) — A strap, band, or the like, forming a loop by which something is suspended or carried, as a strap attached to a rifle and passed over the shoulder.

3.38 Spout — Drinking accessory other than a straw.

3.39 Straw Spout — Silicon tube-based device for sucking liquids from a container.

3.40 Training Set / Transition Set — Transition/training set is to promote feeding habits and to promote independent drinking habits in babies.

3.41 Valve — Component of drinking accessories with an internal vent for the flow of air to facilitate drinking of liquid food easily by the child.

3.42 Water Bottles — Container for drinking water or carry water for kids.

4 MATERIALS

4.1 The material used for feeding and drinking containers, its accessories and cutleries for infants and child use shall be of Polypropylene (PP) confirming to IS 10910 or Polyethersulfone (PES) confirming to ISO 24025-1 or Thermoplastic Elastomer (TPE) confirming to ISO 18064 or any other olefin-based polymer, co-polyester material, or other raw material like silicone rubber which should not have any health hazards to babies and shall not contain Bisphenol A (BPA).

4.2 The details about materials to be used are given in Annex A.

4.3 The accessories shall be made of plastic or silicone rubber. The plastic part or component shall be as per the requirements given in IS 14625 and the silicone rubber part shall be as per the requirements given in IS 3565.

NOTE — Polyvinyl chloride (PVC) and Polyethylene Terephthalate (PET) shall not be used to manufacture drinking and feeding containers, accessories and cutleries.

4.4 Determination of Absence of BPA

Test methods as prescribed in ISO 18857-2 or EN 13130-13 shall be used for determination of absence of BPA. In case of dispute, the ISO 18857-2 shall be the referee method.

5 DESIGN, SHAPE AND SIZE OF CONTAINERS, ACCESSORIES AND CUTLERIES

5.1 Containers

The images of the important design, shape and size of containers commonly used are illustrated below for reference. Besides these, containers of any other design, shape or size shall be agreed upon between the buyer and the suppliers.

5.1.1 Bowl





5.1.2 Drinking Tumbler/ Mugs/ Cups:

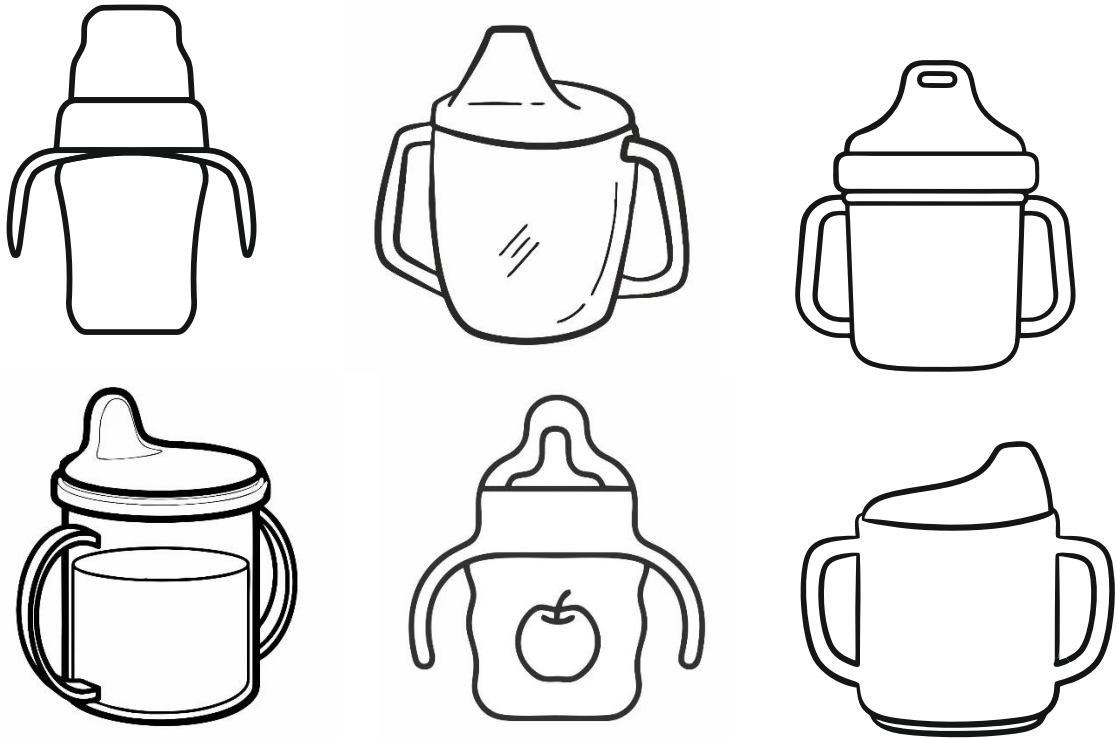

5.1.3 Double-Walled Insulated Sippy Cup

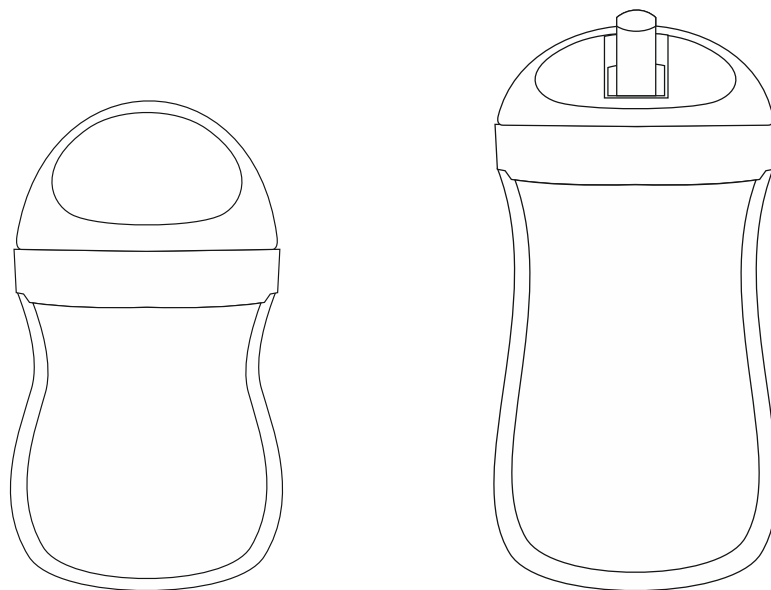

5.1.4 Drinking Glass

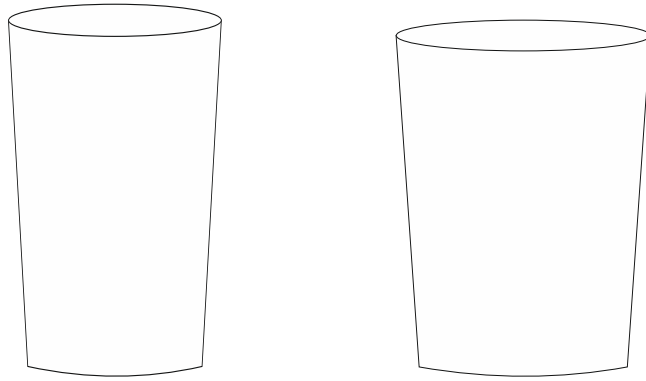

5.1.5 Container with Breast Pump

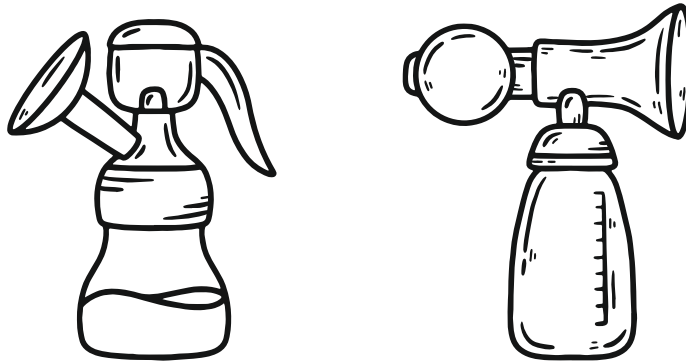

5.1.6 Fresh Food Feeder

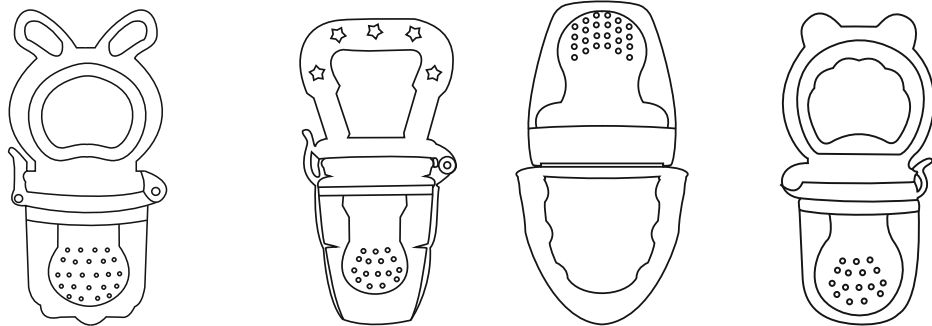

5.1.7 Magic Cup 360 degree

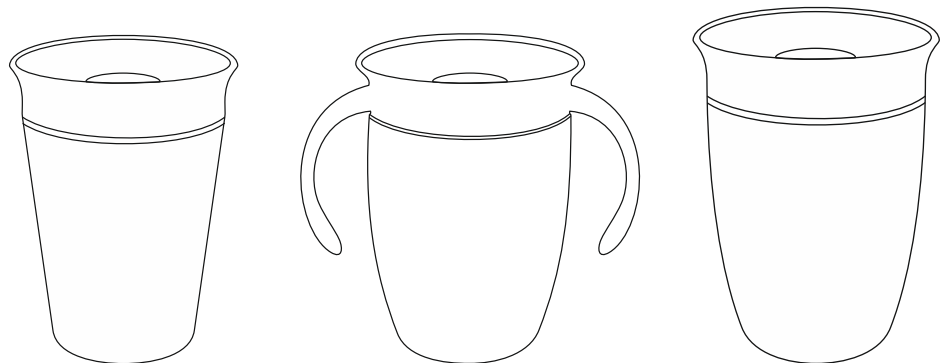

5.1.8 Medicine Feeder

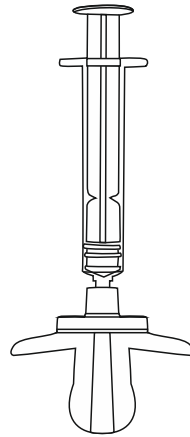
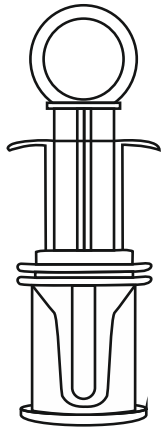

5.1.9 Plate

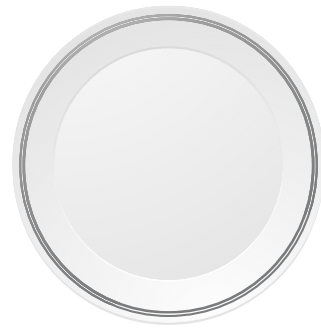
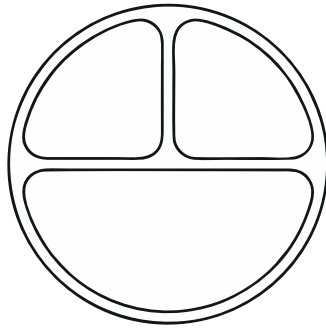

5.1.10 Spout Cup

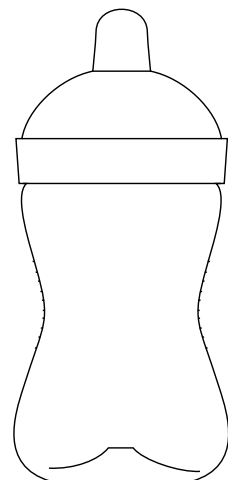
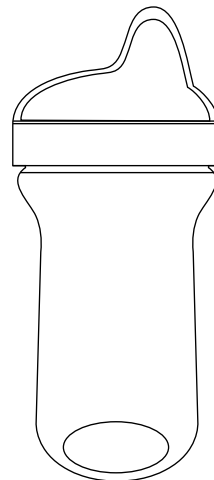
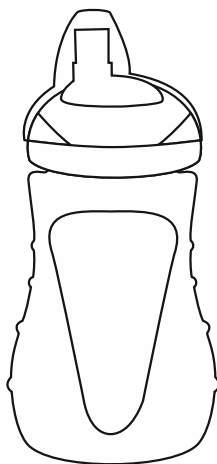
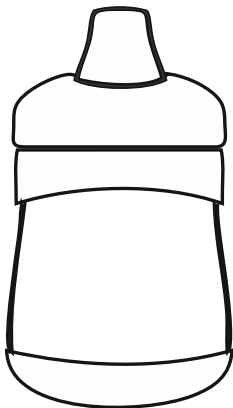

5.1.11 Sippy Straw Bottle

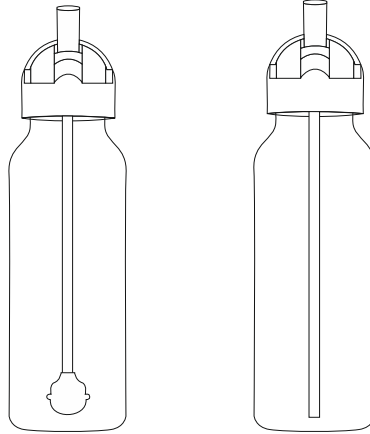

5.1.12 Sippy Spout Bottles

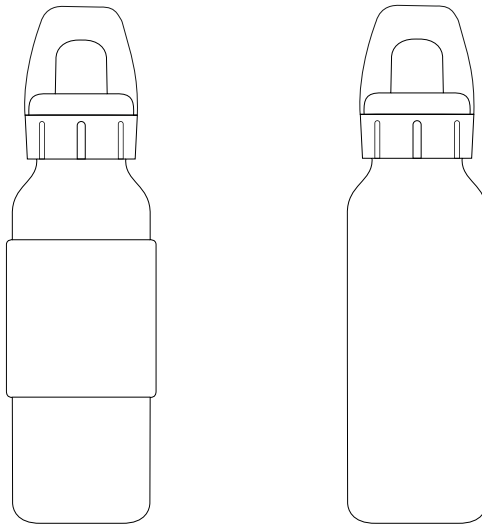

5.1.13 Training Set/Transition Set

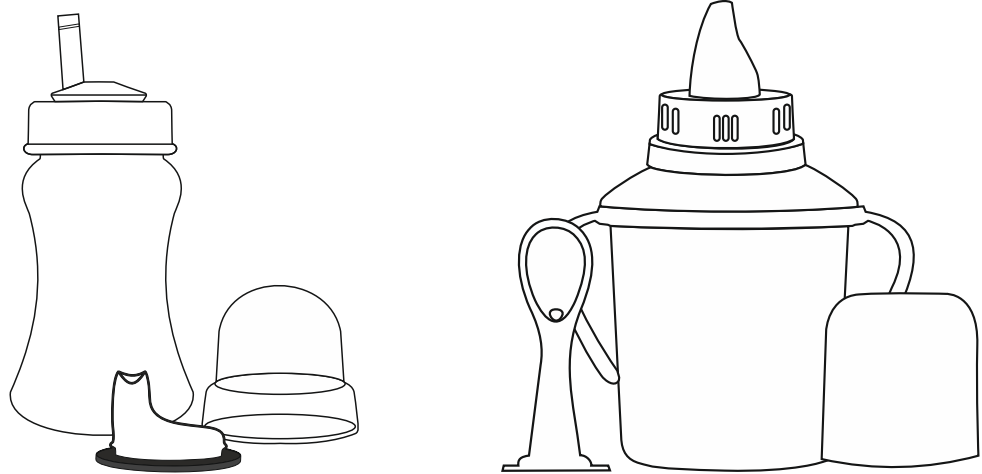

5.1.14 Water Bottles

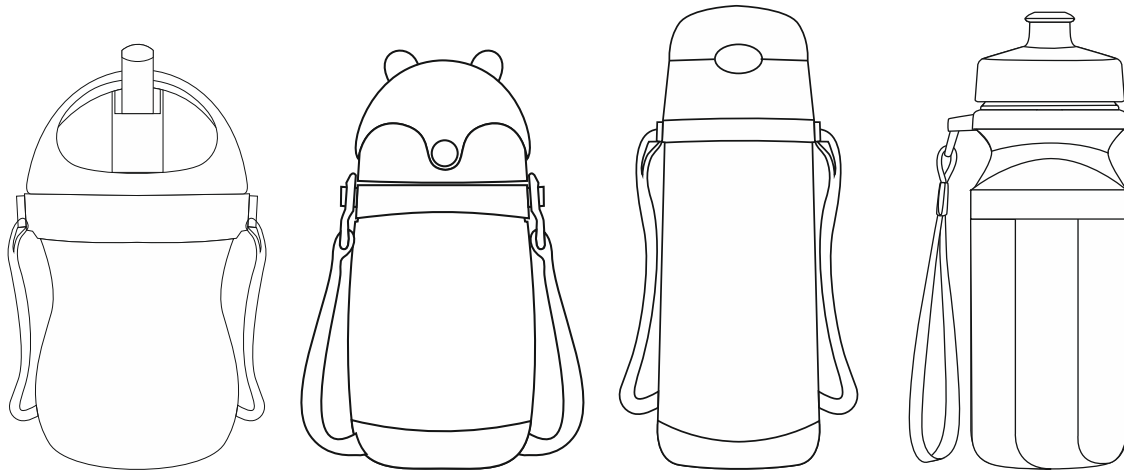

5.2 Accessories

The images of the important design, shape and size of accessories are given below. Beside these, accessories of any other design or size, shall be agreed upon between the buyer and the suppliers.

5.2.1. Spoon

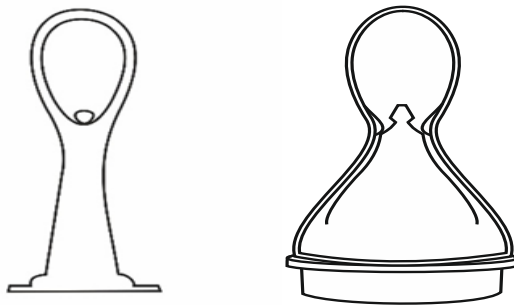

5.2.2. Straw

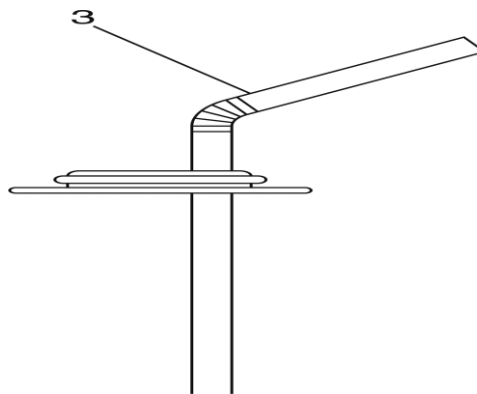

5.2.3 Spout

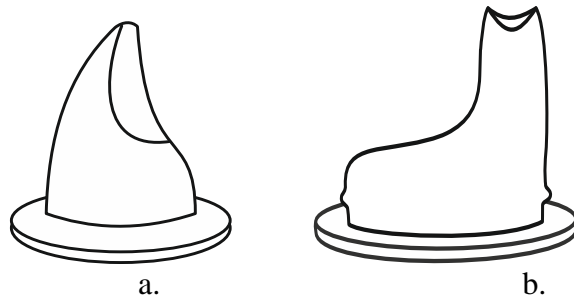

5.2.4 Straw Spout

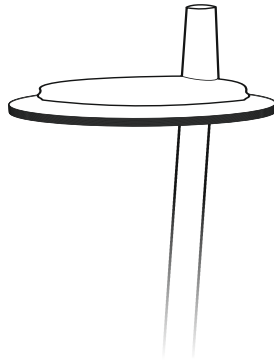

5.2.5 Pipe

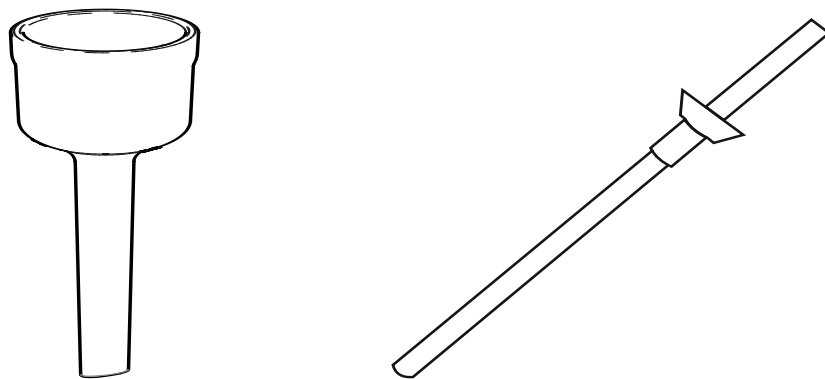

5.2.6 Air Vent Systems

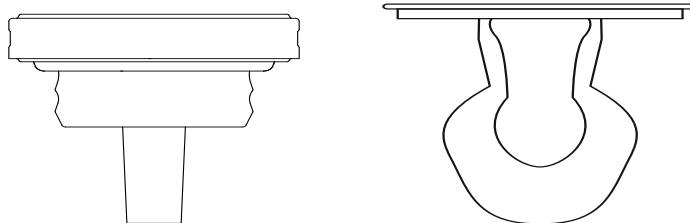

5.2.7 Handle

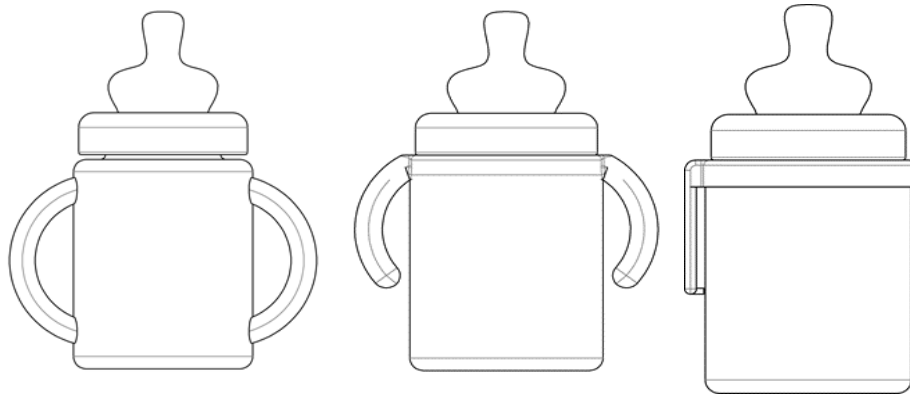
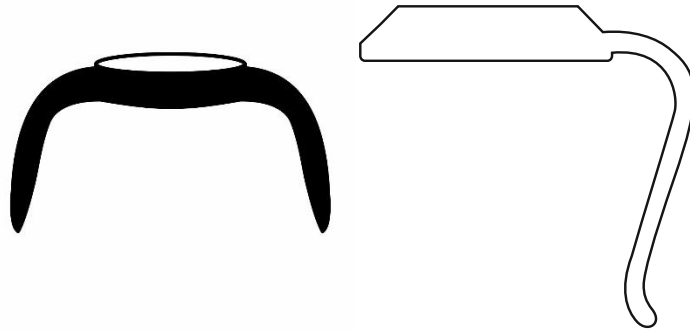
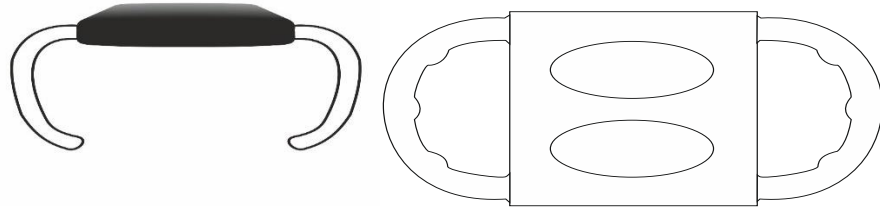

5.2.8 Weight Ball / Gravity Ball

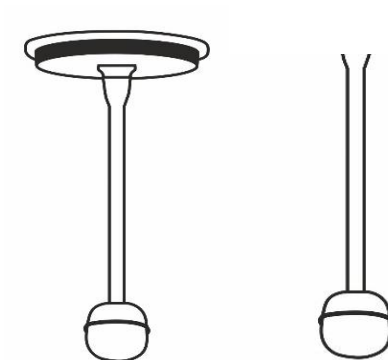

5.2.9 Locking Ring

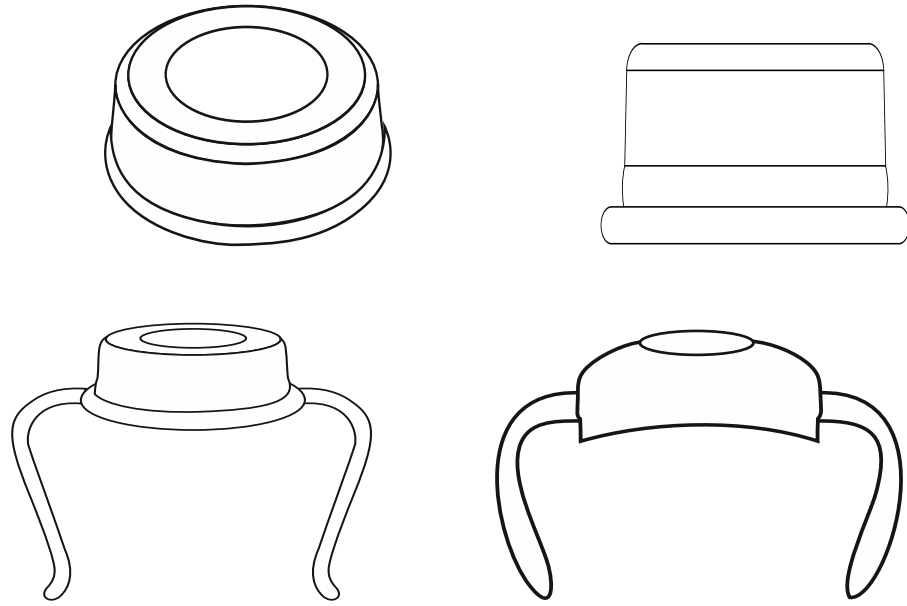

5.2.10 Sealing Disk

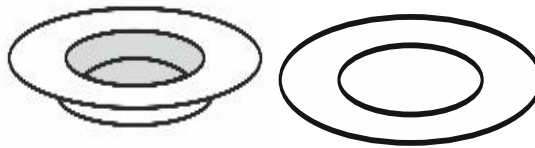

5.2.11 Protecting Cap



5.2.12 Breast Shield

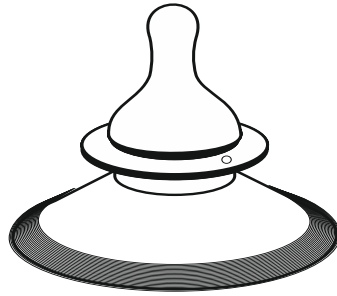

5.2.13 Push and Pull Valve

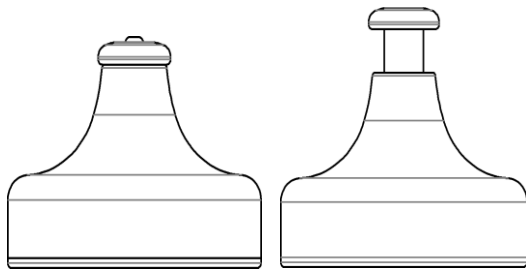

5.2.14 Valve

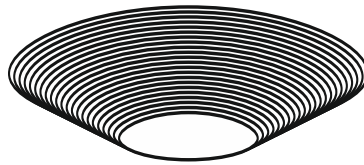

5.2.15 Sling (Strap)

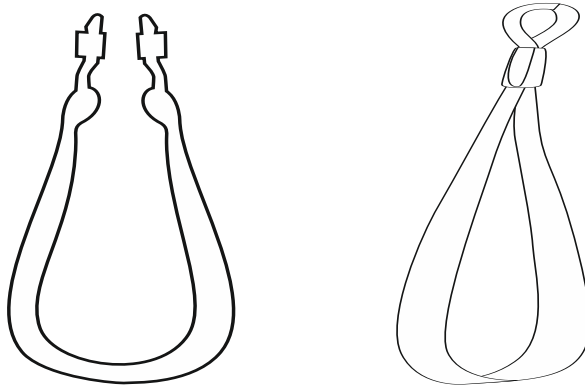

5.3 Cutlery:

5.3.1 Spoon and Fork

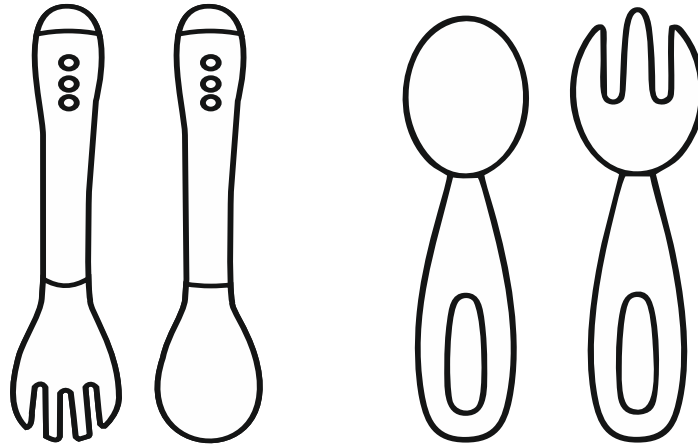

6 GENERAL REQUIREMENTS

6.1 Physical Requirements

6.1.1. Description — The feeding and drinking container, its accessories and Cutleries for infants and Child use shall be of suitable design, shape, and required dimensions as agreed upon between the purchaser and the supplier.

NOTE — The shape of the container, its accessories and cutleries for infants and child use shall be such that it is easily cleanable and does not permit the food remnants to remain stuck inside either in containers or accessories or cutleries. If there are chances of any food being stuck, a cleaning brush that fits the accessory should be provided.

6.1.2 *Manufacture, Workmanship, Finish and Appearance*

6.1.2.1 The feeding and drinking containers, its accessories and cutleries shall be manufactured by a suitable process adhering to good manufacturing practice (GMP).

6.1.2.2 The body of the container, its accessories and cutleries shall be smooth, both internally and externally, free from any visual defects like cavities, crevices, hooks, embedded foreign matters, detrimental bubbles, streaks, flaws, stains, etc. All components of drinking equipment when assembled for use shall be free from points and sharp edges and any harmful extrusions, which are likely to cause injury. All parts which are designed to be detached (e.g., for cleaning) shall not fit within a small parts cylinder in any orientation and without compression.

6.1.3 *Wall Thickness*

The minimum wall thickness shall be declared by the manufacturer. The wall thickness when measured in accordance with 4.5 of IS 2798 shall not be less than the declared minimum value.

6.1.4 Capacity

The containers shall be manufactured in different capacities as agreed between the purchaser and the supplier.

6.1.4.1 Capacity scale

The feeding and drinking container may or may not be marked with graduations at least in milliliters. The drinking equipment may be provided with the following capacity scale:

6.1.4.1.1 If the container is unprinted, then capacity scale may be engraved on the container and if the container is printed then the capacity scale may be clearly printed. The container with printed scale shall be tested for the permanency of pigment in accordance with the method prescribed in Annex B.

6.1.4.1.2 The scale interval and the maximum indicating scale mark shall be as agreed between the purchaser and the supplier. However, the minimum scale mark and interval marking shall be not more than 20 percent of the maximum scale indicating mark.

6.1.4.1.3 The scale marks and the indicating numerical values shall be clear and shall not be affected by high-temperature sterilizing treatment.

NOTE — This test is applicable if the container has capacity scale.

7 REQUIREMENT OF FEEDING AND DRINKING CONTAINERS, IT'S ACCESSORIES AND CUTLERIES MADE UP OF PLASTICS

7.1 Migration Test

7.1.1 Overall Migration Test for Container, Accessories and Cutleries made of Plastics

7.1.1.1 Representative samples of feeding and drinking container, shall be subjected to overall migration test either by filling the whole container or by using sheets cut from the container. In the latter case, the migration value has to be extrapolated to the container contact surface area and the volume of the contents with the following:

- a) Distilled water at 40 ± 2 °C for 2 h, and
- b) n-heptane at 38 ± 1 °C for 30 min.

7.1.1.2 The maximum extraction values for the container material shall not exceed 10 mg/dm² or 60 mg/l (for details *see* IS 9845).

7.1.2 Specific Migration of Heavy Metals of Container, Accessories and Cutleries Made up of Plastics

7.1.2.1 The specific migration is tested to determine the quantity of a specific substance that can migrate from a food packaging material or food container into food. Specific migration limits are usually expressed as mg/kg food.

7.1.2.2 The sample/simulants shall be prepared using the procedure described in IS 9845.

7.1.2.3 The limit of specific migration of all toxic substances when tested as prescribed in column 4 of Table 1 shall not release the substances in quantities exceeding the specific migration limits listed under Table 1.

Table 1
(Clause 7.1.2.3)

Permissible Levels of Heavy Metals in Plastic feeding and drinking containers, its accessories and cutleries

Sl No.	Toxic Substances	Migration Limit, Maximum, mg/kg	Test Method
(1)	(2)	(3)	(4)
i)	Barium	1.0	IS 3025(Part 2)
ii)	Cobalt	0.05	-do-
iii)	Copper	5.0	-do-
iv)	Iron	48.0	-do-
v)	Lithium	0.6	-do-
vi)	Manganese	0.6	-do-
vii)	Zinc	25.0	-do-
viii)	Antimony	0.04	-do-
ix)	Phthalic acid, bis(2-ethylhexyl)ester (DEHP)	1.5	ISO 18856

NOTE — Printing inks used in the printing shall conform to IS 15495.

7.2 Performance Requirements

7.2.1 Environmental Stress-Crack Resistance

The Containers shall be tested in accordance with Method I of IS 8747 and shall show no evidence of stress cracking or leakage after being kept in the oven for 48 h.

7.2.2 Transparency

A feeding and drinking container having a scaling mark, the transparency of the container shall not be less than 70 percent in any light source transmittance when tested in accordance with the method described in Annex C.

NOTE — The test is applicable only for transparent plastic containers

7.2.3 Leakage Test

The feeding and drinking container filled to brim level with water at ambient temperature and closed tight with closures shall be kept for 24 h in a horizontal position. During and at the end

of the period, the feeding and drinking container shall not show any leakages. The feeding and drinking container shall be then held vertically upside down for 10 min and the bottle shall not show any leakages. The feeding and drinking container may be kept on a blotting paper in upside down position and any leakages observed shall be noted.

7.2.4 *Drop Test*

The feeding and drinking container to be filled up to brimful capacity with water at ambient conditions and closed tight with closures shall not show any sign of rupture or leakage when tested in accordance with the method described in Annex D of IS 14625. The dropping height of the Containers shall be 1.2 m.

NOTE — This test is applicable for the drinking and feeding container only.

7.2.5 *Ageing Resistance*

Immerse the feeding and drinking containers into the boiling water for 20 min, then immediately into the ice water for 20 min. Alternately repeat it three times. At the end of the test, the change in the capacity of feeding and drinking containers shall not be more than 3 percent and there shall be no defective changes in the feeding and drinking container. There shall be no significant changes in appearance when the accessories are tested in accordance with the method indicated above.

NOTE — This test is applicable for the feeding and drinking container if the liquid is in hot condition.

7.2.6 *Compressive Deformation Resistance*

The containers shall not get deformed by more than 10 percent in diameter in compressive direction at the compressive load of 2 kgf (19.6 N) when tested in accordance with the method described in Annex E of IS 14625.

NOTE — This test is applicable for the drinking and feeding container only.

7.2.7 *Product Resistance of Printed Containers*

The printed containers when tested in accordance with the method prescribed in 14 of IS 2798 shall not show any significant removal of the print from the Container surface for product fluids like milk, juices, etc. and the print shall be legible to the naked eye after the test.

7.2.8 *Vacuum Test for Performance Evaluation of Breast Pump Attached to Container*

The performance evaluation of breast pump is assessed by carrying out the vacuum test in accordance with test method prescribed in Annex D. The pressure gauge shall not show the negative pressure less than 2.5 psi (17.24 kPa).

8 REQUIREMENTS FOR FEEDING AND DRINKING CONTAINERS, ITS ACCESSORIES AND CUTLERIES MADE UP OF SILICONE RUBBER

8.1 Performance Requirements

8.1.1 Resistance to Autoclaving for Silicone-Based Component

The silicon-based component or parts of the accessories shall show no visual deformation or damage when tested in accordance with Annex E.

8.1.2 Tear Resistance Test

The components and accessories made up of silicone rubber shall not get punctured when tested as per method prescribed in Annexure K of IS 3565. In case, the sample punctures, another piece shall be tested for tensile test (*see 8.1.3*).

8.1.3 Tensile Test

This test shall be conducted only if the components made of silicone rubber punctures in the tear resistance test. The sample shall be taken to have passed the test, if no component tears on the tensile test conducted as per the method prescribed in Annex L of IS 3565.

8.2 Chemical Requirements

8.2.1 The components or parts of accessories made of silicone rubber shall comply with the requirements given in Table 2.

Table 2
(Clause 8.2.1)

Chemical Requirements of Components Made from Silicone Rubber

SI No.	Characteristic	Requirements		Method of Test
		Type 1	Type 2	
(1)	(2)	(3)	(4)	(5)
i)	Water extract a) pH b) Colour c) Turbidity d) odour	7 ± 0.5 Colourless Not turbid Odourless	7 ± 0.5 Colourless Not turbid Odourless	Annex B of IS 3565
ii)	Acetone extract, percent a) Acetone extracted material, percent by mass, <i>Max</i> b) Free sulphur, percent by mass, <i>Max</i>	3.0 0.2	3.0 NA	Annex C of IS 3565
iii)	Ash content, percent by mass, <i>Max</i>	2.0	NA	Annex D of IS 3565
iv)	Volatile components, percent, <i>Max</i>	0.3	0.5	Annex E of IS 3565
v)	Extractable protein content, ppm, <i>Max</i>	50	NA	Annex F of IS 3565

8.2.2 Requirements to Check Release of Harmful Ingredients.

The vulcanizing agents 2-mercaptobenzothiazole (MBT), and antioxidants mentioned in Table 3 below do not represent a definitive list.

NOTE — Chemicals other than those mentioned in Table 3 may be used where toxicological evidence, either on the original chemical or any reaction product, is available to demonstrate that no unacceptable risk will be posed when they are used in silicon products and an appropriate analytical test procedure for determining migration levels exists.

Table 3
(Clause 8.2.2)

Tests to Be Carried Out on Silicone Rubber Materials

SI No.	Materials	Migration of Certain Elements (see 6.2.1)	N-Nitrosamines and N-Nitrosatables	MBT Release	Anti-oxidants Release	BPA release	Volatile compounds content
(1)	(2)	(3)	(4)	(5)	(6)	(7)	(8)
i)	Vulcanised rubber	X	X	X	X	-	-
ii)	Silicone rubber	X	X	-	-	-	X
iii)	Thermoplastic elastomers (TPEs)	X	X	-	-	-	-
iv)	Thermoplastics	X	-	-	-	X	-

8.2.3 N-Nitrosoamines and N-Nitrosatables

When tested in accordance with Annex G of IS 3565, the total N-Nitrosoamines and N-Nitrosatable release of any elastomer or rubber component along with tolerance limits shall be as given in Table 4.

Table 4
(Clause 8.2.3)

Permissible Level of N-Nitrosamines and N-Nitrosatables in Silicone Rubber Products

SI No,	Substance	Maximum Limit mg/kg	Tolerance mg/kg
(1)	(2)	(3)	(4)
i)	N-Nitrosamines	0.01	0.01
ii)	N-Nitrosatables	0.1	0.1

8.2.4 Determination of 2-Mercaptobenzothiazole (MBT)

When elastomeric component of silicone rubber-based components tested in accordance with Annex H of IS 3565, the migration of the 2-mercaptobenzothiazole (MBT) release shall not exceed 8 mg/kg (8 ppm).

8.2.5 Determination of Antioxidants

8.2.5.1 When elastomeric components of silicone rubber-based components are tested in accordance with Annex H of IS 3565, the migration of the antioxidant [2,6-bis (1,1-dimethylethyl)-4-methyl-phenol (BHT) chemical shall not exceed 30 µg/ 100 ml or 60 µg/dm².

8.2.5.2 When elastomeric components of silicone rubber-based components are tested as given in Annex H, the migration of the antioxidant 2,2'-methylenebis [6-(1,1-dimethylethyl)-4-methylphenol] (Antioxidant 2246) shall not exceed 15 µg/100 ml or 30 µg/dm².

8.2.6 Specific Migration of Heavy Metals of Containers, Accessories and Cutleries Made of Silicone Rubber

8.2.6.1 The migration of elements from silicone rubber parts shall comply with the limits given in Table 5.

8.2.6.2 Procedure

Take a test portion of 1 000 mg of the material and add 50 times its mass of an aqueous HCl solution at 37 ± 2 °C of $c(\text{HCl}) = 0.07 \pm 0.005$ mol/l, avoiding heating of the material. Shake for 1 min. Check the acidity of the mixture. If the pH is greater than 1.5, add drop wise, while shaking the mixture an aqueous solution of $c(\text{HCl})$ approximately 2 mol/l [2.0 ± 0.2 mol/l] until the pH of the mixture is between 1.0 and 1.5. Protect the mixture from light. Agitate the mixture continuously at 37 ± 2 °C for 1 h and then allow standing for 1 h at 37 ± 2 °C. Without delay, efficiently separate the solids from the solution, by filtration. If the resulting solution are to be stored for more than one working day prior to elemental analysis, stabilize them by addition of hydrochloric acid so that concentration of stored solution is approximately $c(\text{HCl}) = 1$ mol/l [see IS 9873 (Part 3)].

8.2.6.3 The limits and tolerances of the pigments and colorants used in the printing shall conform to IS 15495.

8.2.6.4 The components made of silicone rubber shall also comply with the chemical requirements given in Table 5.

Table 5
(Clause 8.2.6.1 and 8.2.6.4)

Specific Migration of Heavy Metals of Containers, Accessories and Cutleries Made of Silicone Rubber

Sl No.	Heavy Metals	Maximum Limit ppm Max	Ref to, IS No.
(1)	(2)	(3)	(4)

i)	Antimony	15	IS 15303
ii)	Arsenic	10	IS 3025 (Part 37)
iii)	Chromium	10	IS 3025 (Part 52)
iv)	Mercury	10	IS 3025 (Part 48)
v)	Cadmium	20	IS 3025 (Part 41)
vi)	Lead	25	IS 3025 (Part 47)
vii)	Barium	100	IS 1699
viii)	Selenium	100	IS 15303/IS 3025 (Part 56)

9 ADDITIONAL REQUIREMENTS FOR ECO-MARK

9.1 General Requirements

9.1.1 The product shall conform to the requirements for quality, safety and performance prescribed.

9.1.2 The manufacturer shall produce to BIS the consent clearance as per the provisions of *Water (Prevention & Control of Pollution) Act, 1974* and *Air (Prevention & Control of Pollution) Act, 1981* along with the authorization, if required under *Environment (Protection) Act, 1986* and the rules made there under while applying for the ECO-Mark. The manufacturer shall produce documentary evidence with respect to the compliance of regulation under *Prevention of Food Adulteration Act, 1954* and *Drugs and Cosmetic Act, 1940* and Rules made thereunder, wherever necessary.

9.1.3 The product must display a list of critical ingredients in descending order of quantity present expressed as percent of the total. The list of such ingredients shall be identified by Bureau of Indian Standards.

9.1.4 The product packaging shall display in brief the criteria based on which the product has been labelled as 'Environment Friendly'.

9.1.5 The material used for product packaging shall be recyclable or biodegradable.

9.1.6 It shall also suitably mention that ECO-Mark label is applicable only to the packaging material/package, if content is not separately covered under ECO-Mark. It may be stated that ECO-Mark is applicable to the product or packaging material or both.

10 PRINTING AND DECORATION

The drinking and feeding containers, accessories should be either printed, engraved or embossed. Printing inks used in the printing shall conform to IS 15495. The items made of the silicone rubber should be embossed or engraved where ever printing is not possible.

11 SAMPLE PREPARATION

11.1 The sample preparation applies to all tests. Representative samples of the material shall be drawn (*see* IS 4905).

11.2 Samples from re-usable products shall be immersed in boiling water for 10 min without touching the walls of the container.

NOTE — This is to remove the surface coating arising from the manufacturing processes and ensure that the materials used are stable in boiling water.

11.3 New samples, preferably from the same batch, shall be used for each test.

11.4 Samples and test portions shall only be handled with suitable (non-rubber or plastic) gloves and shall only be stored insecurely fastened, migration-free (glass) containers and protected from light.

12 PACKING AND MARKING

12.1 Packing

The feeding and drinking containers and its accessories shall be packed as agreed to between the manufacturer and buyer and shall include clear legible instructions for the use and hygienic care of the product.

12.2 Marking

12.2.1 The following information shall be visible on the packaging or on a leaflet placed inside the product and/ or on the external packaging material. Each carton containing the feeding and drinking container and its accessories shall be permanently marked with the following:

- a) Indication of the source of manufacture and trade-mark, or the company responsible for placing the product in the market, if any;
- b) Nominal capacity;
- c) Batch No. and Code No.;
- d) Month and year of manufacture;
- e) Made from plastics/silicon materials meant for food contact applications indicating material used;
- f) Product symbol in line with IS 14534;
- g) Instructions for use and hygienic care of the product shall be printed in English/ Hindi/ regional language and may be included in a separate leaflet placed in or/on the product as given in Clause 9.3; and
- h) Any other statutory requirements.

12.2.2 *BIS Certification Marking*

The product(s) conforming to the requirements of this standard may be certified as per the conformity assessment schemes under the provisions of the Bureau of Indian Standards Act, 2016 and the Rules and Regulations framed thereunder, and the products may be marked with the Standard Mark.

13 INSTRUCTIONS FOR USE

13.1 The following information shall be provided:

- a) Information for the safe use of the product; and
- b) Information on unsuitable common methods of heating that might damage the product.

13.2 For re-usable products, the following additional instructions shall be provided:

- a) At least one method of cleaning;
- b) Before first use, clean the product; and
- c) Information on unsuitable common methods of cleaning, storage and use which might damage the product.

13.3 For products with feeding and drinking accessories the following **warnings** shall be provided in the form given:

WARNING - For your child's safety and health ssss such as

- a) Always use this product with adult supervision.
- b) Always check food temperature before feeding.
- c) Keep all components not in use out of the reach of children.

NOTE — It is recommended that the supplier of drinking equipment include informative literature to explain the reasons and background for these warnings.

14 SAMPLING AND CRITERIA FOR CONFORMITY

The samples of the feeding and drinking containers and its accessories shall be drawn and the criteria for conformity determined as prescribed in Annex F.

ANNEX A
(Clause 4.2)

LIST OF MATERIAL FOR MANUFACTURE OF PLASTIC DRINKING, FEEDING CONTAINERS, ITS ACCESSORIES AND CUTLERIES.

(1) (i) Polypropylene consists of basic polymers manufactured by the catalytic polymerization of propylene.

21 CFR 177.1520 (a)(3)(i)

Olefin basic copolymers consist of basic copolymers manufactured by the catalytic copolymerization of:

(i) Two or more of the 1-alkenes having 2 to 8 carbon atoms. Such olefin basic copolymers contain not less than 96 weight percent of polymer units derived from ethylene and/or propylene, except that:

- (a)(1) Olefin basic copolymers manufactured by the catalytic copolymerization of ethylene and hexene-1 or ethylene and octene-1 shall contain not less than 90 weight percent of polymer units derived from ethylene.
- (2) Olefin basic copolymers manufactured by the catalytic copolymerization of ethylene and hexene-1 shall contain not less than 80 but not more than 90 weight percent of polymer units derived from ethylene.
- (3) Olefin basic copolymers manufactured by the catalytic copolymerization of ethylene and pentene-1 shall contain not less than 90 weight percent of polymer units derived from ethylene.
- (4) Olefin basic copolymers manufactured by the catalytic polymerization of ethylene and octene-1 shall contain not less than 50 weight percent of polymer units derived from ethylene.
- (b) Olefin basic copolymers manufactured by the catalytic copolymerization of ethylene and 4-methylpentene-1 shall contain not less than 89 weight percent of polymer units derived from ethylene;
- (c)(1) Olefin basic copolymers manufactured by the catalytic copolymerization of two or more of the monomers ethylene, propylene, butene-1, 2-methylpropene-1, and 2,4,4- trimethylpentene-1 shall contain not less than 85 weight percent of polymer units derived from ethylene and/or propylene;
- (2) Olefin basic copolymers manufactured by the catalytic copolymerization of propylene and butene-1 shall contain greater than 15 but not greater than 35 weight percent of polymer units derived from butene-1 with the remainder being propylene.

- (d) Olefin basic terpolymers manufactured by the catalytic copolymerization of ethylene, hexene-1, and either propylene or butene-1, shall contain not less than 85 weight percent polymer units derived from ethylene.
- (e) Olefin basic copolymers manufactured by the catalytic polymerization of ethylene and octene-1, or ethylene, octene-1, and either hexene-1, butene-1, propylene, or 4- methylpentene-1 shall contain not less than 80 weight percent of polymer units derived from ethylene.

21 CFR 177.1520 (b)

- (b) Olefin basic copolymers manufactured by the catalytic copolymerization of ethylene and 4- methylpentene-1 shall contain not less than 89 weight percent of polymer units derived from ethylene.

21 CFR 177.1520 (c) Specifications

Item	Olefin polymers	Density	Melting Point (MP) or softening point (SP) in °C	Maximum extractable fraction (expressed as percent by weight of the polymer) in <i>n</i>-hexane at specified temperatures	Maximum soluble fraction (expressed as percent by weight of polymer) in xylene at specified temperatures
(1)	(2)	(3)	(4)	(5)	(6)
1.1a	Polypropylene described in paragraph (a)(1)(i) of this section	0.880 – 0.913	MP: 160-180 °C	6.4 percent at reflux temperature	9.8 percent at 25 °C
3.1a	Olefin copolymers described in paragraph (a)(3)(i) of this section for use in articles that contact food except for articles used for packing or holding food during cooking; except olefin copolymers described in paragraph (a)(3)(i)(a)(3) of this section and listed in item 3.1c of this table and olefin copolymers described in paragraph (a)(3)(i)(e) of this section and listed in item 3.1b of this table	0.85 – 1.00	-	5.5 percent at 50 °C	30 percent at 25 °C

(2) (i) The selective number of components or parts of accessories in combination with plastics shall be made of natural rubber or silicone rubber, together with necessary compounding and vulcanizing ingredients. In case of natural rubber, solid rubber or latex may be used.

(ii) All such parts or components shall be free from grits, reclaimed rubber or vulcanized waste. The rubber/silicone mix shall not include any ingredient known to be injurious or poisonous to human beings.

(iii) All ingredients used in the manufacture of components and accessories shall be free from harmful substances liable to extraction by contact with milk/liquid food or which may cause development of undesirable odour, taste or discolouration. Softeners, organic accelerators, vulcanizing agents and antioxidants, if incorporated shall not impart any undesirable odour or taste to the finished parts or components.

ANNEX B
(Clause 6.1.4.1.1)

TEST FOR PERMANENCY OF PIGMENT

B-1 GENERAL

This test is meant only for those feeding containers which have a printed scale and graduations.

B-2 REAGENTS

B-2.1 Sodium Bichromate (*see* IS 249).

B-2.2 Concentrated Sulphuric Acid [Relative density:1.834 approx. (*see* IS 266)].

B-3 PROCEDURE

B-3.1 Weigh about 20 g of sodium dichromate and dissolve in 1 500 ml of concentrated sulphuric acid and dilute to 2 500 ml with water. Immerse the Containers in the solution at room temperature for 15 min. Rinse the samples with water and dry.

B-3.1.1 The Containers shall be taken as having satisfied the requirements of the test if the printed impressions do not become illegible.

Annex C
(Clause 7.2.2)

DETERMINATION OF TRANSPARENCY

C-1 GENERAL

Transparency of plastics feeding Container can be tested either by using integration ball type light transmittance measurement apparatus or by method prescribed in IS 13360 (Part 9/Sec 5). In case of dispute, the test method given in IS 13360 (Part 9/Sec 5) shall be used as referee method.

C-2 INTEGRATION BALL TYPE LIGHT TRANSMITTANCE MEASUREMENT METHOD

C-2.1 Test Specimen

Test specimen shall be prepared from the part of the feeding Container where scale marks or other marks are not found.

C-2.2 Apparatus

The optical series principle diagram of integration ball type light transmittance measurement device is shown in **Fig. 1** and **Fig. 2**. The device shall conform to the optical conditions specified in Table 6.

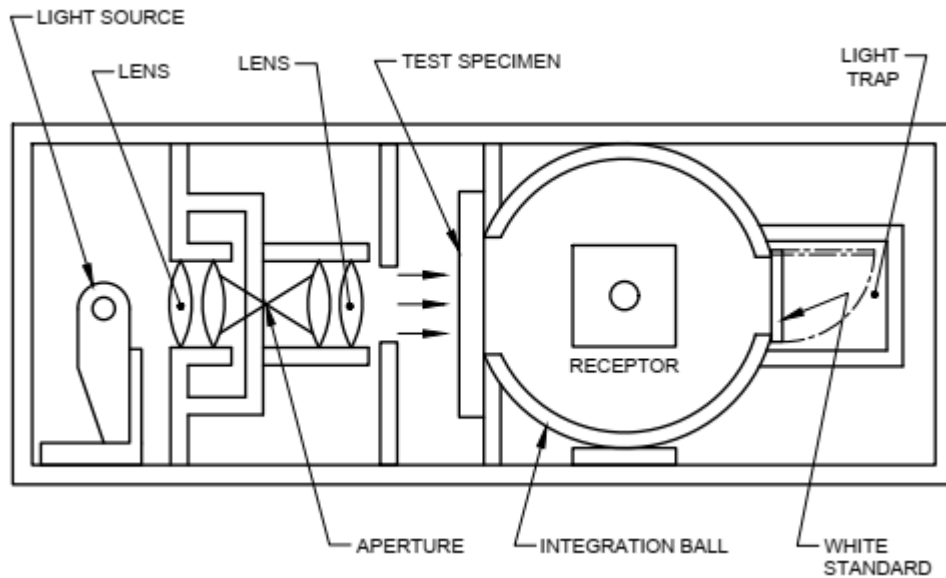

FIG. 1 PRINCIPLE DIAGRAM OF DEVICE

C-2.3 Test Specimen

C-2.3.1 The size of test specimen shall be 50×50 mm and the thickness shall be the original thickness of the test specimen.

C-2.3.2 Three test specimens shall be prepared.

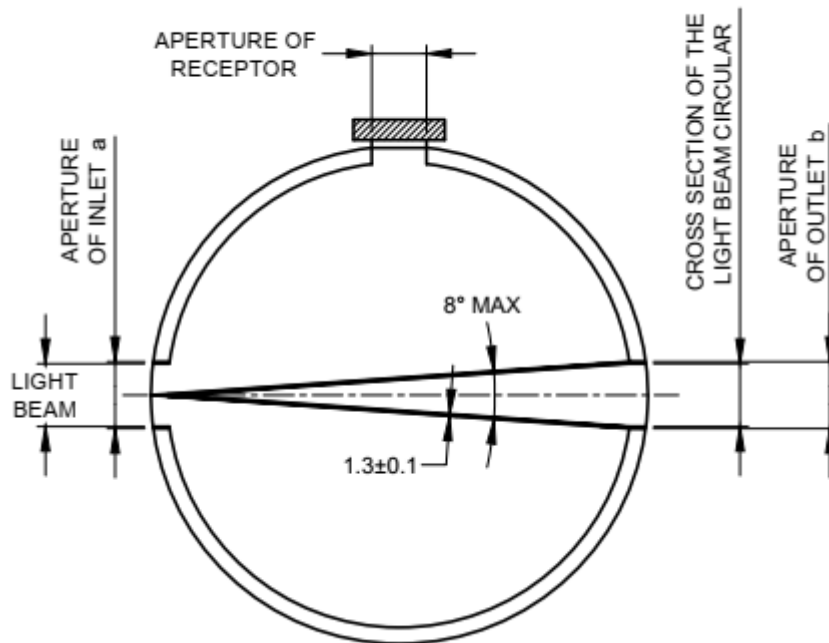

FIG. 2 CONDITION OF THE INTEGRATION BALL

C- 2.4 Measurement

C- 2.4.1 Install the white standard plate, adjust the reading (T_1) of the device's current meter to be 100; adjust the amount of incident light.

C- 2.4.2 Under the status where the white standard plate is installed, install and measure the test specimen to obtain the indication (T_2) of the current meter. The full light transmittance shall be calculated according to the following formula:

$$T = \frac{T_2}{T_1} \times 100$$

where

T = full light transmittance (percent)

Table 6
 (Clause C-2.2)

Optical Condition of Device

Sl No.	Item	Conditions
(1)	(2)	(3)
(i)	Integration ball	The sum of areas of light's inlets and outlet (the installation part of the test specimens and the white standard plate) ($a + b + c$) shall be less than 4 percent of overall internal surface area of the ball (Refer

		to Fig. 2). The centre lines of the outlet and inlet shall be on the same large circle of the ball. The angle formed by the outlet diameter and the center line of the inlet shall be within 8°.
(ii)	Reflection surface	<p>The white standard plate shall have same high reflectivity to full wavelength of the visible light. Magnesium oxide, barium sulphate and aluminium oxide, etc. can meet such requirements. The interior of the integration ball shall be coated with a material having the same reflectivity as the white standard plate.</p> <p>The light beams used to shine on the test specimen shall be parallel light. Lights deviated from the optical axis for more than 3° shall not be used. The centre of light beam shall coincide with the centre line of the outlet.</p>
(iii)	Light beam	The cross-section of the light beam at the outlet shall be circular and bright; the angle formed by its diameter and the centre of inlet shall be $1.3 \pm 0.1^\circ$ smaller than the angle formed by the outlet diameter. The cross section of the light beam at the integration ball shall conform to Fig. 2.
(iv)	Light trap	The light trap when not installed with the test specimen of the white standard plate shall be able to completely absorb the light.
(v)	Light source	<p>The light source shall be the standard light source C.</p> <p>The comprehensive sensitivity of the receptor and the visually sensitivity filter used shall satisfy the Y value of Luther.</p>
(vi)	Receptor	Conditions at the standard light source C. However, when designated specifically, the one which satisfies the Y value of Luther conditions at the standard light source A can be used.

ANNEX D
(Clause 7.2.8)

**VACUUM TEST FOR PERFORMANCE EVALUATION OF BREAST PUMP
ATTACHED TO CONTAINER**

D-1 GENERAL

The breast pump effectiveness is evaluated by measuring the vacuum (also called suction) of the pump.

D-2 APPARATUS

The pump is attached to a pressure gauge which measures the negative pressure. The gauge needle points to a number from 0 to 450 mmHg. The reading of the gauge is then compared to a standard range of breast pump i.e. 210 mm Hg to 450 mmHg. The figure of pressure gauge (Fig. 3) is given below.

D-3 SAMPLE SIZE

The sample size shall be ten breast pump with container, taken at random from a batch, divided into two sets of 5 each, designated as Set 1 and Set 2.



FIG. 3 PRESSURE GAUGE

D-4 PROCEDURE

D-4.1 All the parts to the pump, the flange (sometimes called a Breast shield), membrane and the valve are to be checked thoroughly prior to the commencement of the test. Even a small tear in the membrane can affect pump performance.

D-4.2 Securely attach a single bottle and all of the pump parts to the tubing.

D-4.3 If not already attached, insert the vacuum gauge into the hole in the rubber stopper. The pull tab of the rubber stopper should be in the back of the rubber stopper.



FIG. 4

D-4.4 Insert the rubber stopper containing the gauge firmly into the 24 mm flange. Ensure a complete seal by firmly pressing in all edges of the rubber stopper.

D-4.5 Set the pump's vacuum regulator dial to the minimum/ low setting.

D-4.6 Turn on the pump and look at the gauge to read what the value is on MIN/low. Record this value.

D-4.7 Gradually increase the suction level on the vacuum regulator dial and watch the gauge to see if the pressure values increase in response. Continue to adjust the suction level on the pump until it is on the MAX/high setting. Record this value.

D-5 CALCULATION

Record the pressure gauge dial reading. It should not be less than 210 mmHg.

Annex E
(Clause 8.1)

CHANGE IN PHYSICAL PROPERTIES ON AUTOCLAVING

E-1 OUTLINE OF THE METHOD

The silicon component is autoclaved for a fixed time at constant temperature and the change in the physical appearance of the silicon component, as examined visually, is reported.

E-2 APPARATUS

E-2.1 Autoclave, capable of being maintained at 121 ± 2 °C and at 0.1 MPa.

E-2.2 Hot Air Oven, capable of being maintained at 105 ± 2 °C.

E-3 PROCEDURE

E-3.1 Take three silicon components and autoclave them in 250 ml of water for 1 h at 121 ± 2 °C and 0.1 MPa. Keep the component in a hot air oven maintained at 105 ± 2 °C for 1h, and examine the silicon component after cooling to room temperature for any sign of deterioration such as tackiness, hardness, cracks and discolouration.

ANNEX F
(Clauses 14)

SAMPLING AND CRITERIA OF CONFORMITY

F-1 SCALE OF SAMPLING

F-1.1 Lot

In any consignment, all the containers of the same material, size and drawn from a single batch of manufacture shall be grouped together to constitute a lot.

F-1.2 Scale of Sampling

For ascertaining the conformity of the lot to the requirements of this standard, tests shall be carried out for each lot separately. The number of Containers to be sampled from a lot shall be in accordance with Table 7.

F-1.3 The Containers shall be selected at random from the lot. To ensure the randomness of selection, methods given in IS 4905 may be followed.

F-2 CRITERIA FOR CONFORMITY

F-2.1 Manufacture, Workmanship, Finish and Appearance

The sample Containers selected as per col 2 of Table 7 shall be examined for manufacture, workmanship, finish and appearance. Any Container failing in one or more of the requirements shall be termed as defective. The lot shall be accepted under this head if the number of defective Containers in sample does not exceed the acceptance number given in col 3 of Table 7.

F-2.2 Capacity (6.1.4)

5 Containers for lot size up to 5 000 and 10 Containers for lot size above 5 000 shall be selected at random from the samples already drawn according to E-1.3. There shall be no failure if the lot is to be accepted under this clause.

F-2.3 Environmental Stress-Crack Resistance (7.2.1), Transparency (7.2.2), Leakage test (7.2.3), Ageing resistance (7.2.5) Compressive deformation resistance (7.2.6), Product resistance test for printed Containers (7.2.7) and Vacuum Pressure test for Breast pump (7.2.8)
The number of sample Containers to be drawn shall be in according to col 5 of Table 7. Each of the sample container shall be subjected to Environmental Stress-Crack Resistance (7.2.1), Transparency (7.2.2), Leakage test (7.2.3), Ageing resistance (7.2.5), Compressive deformation resistance (7.2.6), Product Resistance test for printed Containers (7.2.7) and Vacuum Pressure test for Breast Pump (7.2.8). The number of failures shall not exceed the acceptance number given in col 6 of Table 7 for all tests except leakage test. For leakage test the acceptance number is zero, that is no failure shall occur for lot acceptance.

F-2.4 Drop Test (7.2.4)

The sample containers as given in test method (7.2.4) shall be drawn from the lot and these shall be subjected to drop test. There shall be no rupture or leakage in any Container after the test for acceptance. In case even one container has any sign of rupture or leakage, the lot shall be considered as not conforming to the requirements of this specification.

Table 7
(Clauses F-1.2, F-2.1 and F-2.3)

Scale of Sampling and Acceptance Number

Sl. No.	Lot Size	Manufacture, Workmanship, Finish and Appearance		For Transparency (7.2.2), Leakage Test (7.2.3), Ageing Resistance (7.2.5), Compressive Deformation Resistance (7.2.6) and Product Resistance of Printed Containers (7.2.7)	
		Sample Size	Acceptance Number	Sample Size	Acceptance Number
(1)	(2)	(3)	(4)	(5)	(6)
i)	Up to 500	13	1	5	0

sii)	501 to 1 000	20	2	8	0
iii)	1 001 to 3 000	32	3	13	0
iv)	3 001 to 5 000	50	5	20	1
v)	5 001 and above	80	7	32	1