

जिम्नास्टिक में प्रयुक्त क्षैतिज बार — विशिष्टि
(दूसरा पुनरीक्षण)

Horizontal Bars Used in
Gymnastics — Specification
(Second Revision)

ICS 97.220.30; 97.220.40

© BIS 2024



भारतीय मानक ब्यूरो
BUREAU OF INDIAN STANDARDS
मानक भवन, 9 बहादुर शाह ज़फर मार्ग, नई दिल्ली - 110002
MANAK BHAVAN, 9 BAHADUR SHAH ZAFAR MARG
NEW DELHI - 110002

www.bis.gov.in www.standardsbis.in

September 2024

Price Group 7

FOREWORD

This Indian Standard (Second Revision) was adopted by the Bureau of Indian Standards, after the draft finalized by the Sports Goods Sectional Committee had been approved by the Production and General Engineering Division Council.

Horizontal bars are gymnastic equipment which are used both in physical training and in competitions. The gymnast performs on the bar by movements of swinging and vaulting.

This standard was first published in 1963 and was subsequently revised in 1982. In this revision, requirements have been altered to align the standard with the latest international rules of the game and to keep pace with the latest technological developments and international practices. In this revision the following major changes have been made:

- a) Construction and workmanship of the bar have been updated;
- b) Shape and dimension of the bar have been updated; and
- c) Performance requirements have been modified.

The composition of the Committee, responsible for the formulation of this standard is given in [Annex E](#).

For the purpose of deciding whether a particular requirement of this standard is complied with, the final value, observed or calculated, expressing the result of a test or analysis, shall be rounded off in accordance with IS 2 : 2022 'Rules for rounding off numerical values (*second revision*)'. The number of significant places retained in the rounded off value should be the same as that of the specified value in this standard.

Indian Standard

HORIZONTAL BARS USED IN GYMNASTICS — SPECIFICATION

(*Second Revision*)

1 SCOPE

This standard specifies the requirements for horizontal bars used in gymnastic competitions and training. It does not provide the specifications for low horizontal bars used for learning.

2 REFERENCES

The standards given below contain provisions which, through reference in this text, constitute provisions of this standard. At the time of publication, the editions indicated were valid. All standards are subject to revision, and parties to agreements based on this standard are encouraged to investigate the possibility of applying the most recent edition of the standards:

<i>IS No.</i>	<i>Title</i>
IS 1239 (Part 2) : 2011	Steel tubes, tubulars and other steel fittings — Specification: Part 2 Steel pipe fittings (<i>fifth revision</i>)
IS 2365 : 2018	Steel wire suspension ropes for lifts, elevators and hoists — Specification (<i>second revision</i>)

3 TERMINOLOGY

3.1 Additional Falling Weight — Cylindrical test body of given dimensions and mass inside the pendulum producing an additional impact stress on the gymnastics apparatus during pendulum swing.

3.2 Cable Tension — The predetermined value of force (N) exerted on the mounting cables of the completely-mounted unloaded horizontal bar.

3.3 Definition of Spatial Dimensions — For the determination of the vertical and horizontal deflection of the midpoint of the bar, the spatial dimensions are defined as illustrated in [Fig. 1](#).

3.4 Deflection — The measured distance (mm) between the starting position and the maximum displacement of the midpoint of the bar in vertical and horizontal direction respectively.

3.5 Frequency of Oscillation — Reciprocal of the value determined by the duration of the half amplitude interval divided by the number of oscillations of the bar-pendulum system within the half amplitude interval. The frequency is expressed in Hz (*see Fig. 2*).

3.6 Half Amplitude — Value of the amplitude (mm) of the first oscillation which is equal to or less than half the maximum amplitude.

3.7 Half Amplitude Interval — Duration of oscillation (ms) between the passage of the maximum amplitude and the reaching of the half amplitude (*see Fig. 2*).

3.8 Hanging Position — Stable equilibrium position of the hanging pendulum under gravity conditions only.

3.9 Horizontal Position — Position of the attached pendulum rectangular to the hanging position.

3.10 Initial Tension — Predetermined value of the force exerted on the bar, composed of the gravity of the attached pendulum and an additional tractive force pulling the bar-pendulum system vertically downwards.

3.11 Internal Drop Height — Predetermined sliding distance of the additional falling weight inside the pendulum.

3.12 Maximum Amplitude — Value of the amplitude (mm) of the first oscillation of the bar-pendulum system after the release of the initial tension.

3.13 Maximum Force (F_{max}) — The maximum value of the reaction force in the direction of the pendulum's centre of gravity measured as the sum of the forces exerted on both grasping arms during the pendulum swing, expressed in Newton (N).

To access Indian Standards click on the link below:

https://www.services.bis.gov.in/php/BIS_2.0/bisconnect/knownyourstandards/Indian_standards/isdetails/

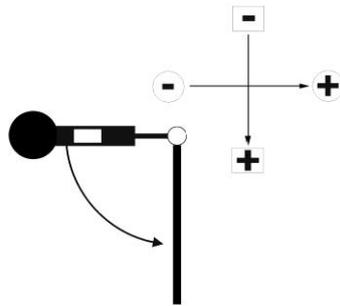

FIG. 1 DEFINITION OF SPATIAL DIMENSIONS (PENDULUM IN HORIZONTAL POSITION BEFORE RELEASE)

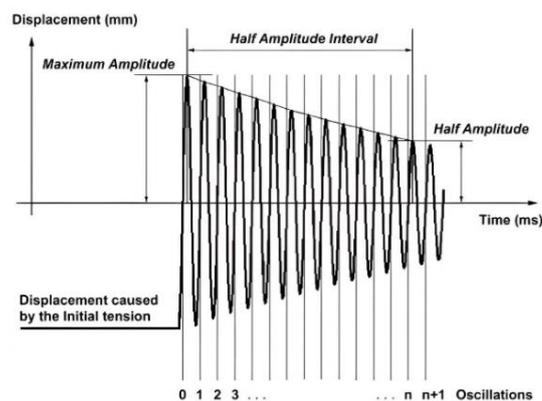

FIG. 2 OSCILLATION DAMPING PARAMETERS

3.14 Pendulum — Tubular test body of given dimensions and mass with an additional low-friction falling weight inside. The test body is attached to the bar with the help of two inflexible grasping arms, each of which is at the same distance from the midpoint of the bar, guaranteeing a low-friction

3.15 Starting Position — The position of the unloaded bar from which the total deflection in vertical and horizontal direction is determined. The midpoint of the bar shall serve as the point of reference for the measurements.

3.16 Static Tractive Force — The predetermined value of force (N) exerted on the midpoint of the bar, pulling the bar vertically downwards.

4 CONSTRUCTION AND WORKMANSHIP

4.1 The horizontal bar shall be composed of a round bar with a constant diameter, positioned horizontally and supported by two upright supports. These supports are firmly placed on the floor and equipped with extra floor plates to distribute force.

4.2 The height of the horizontal bar must be adjustable for additional 10 cm to the standard height. Height changes shall be possible by devices at the supports above the upper surface of the

landing mat. Wires and chains shall be long enough to increment the height. The distance between two sockets shall not be less than 200 cm.

4.3 The bar pins shall not project, in order to avoid all possibility of injury by contact with them. The upright, the turnbuckle meter, the turnbuckle nut and the chain shall be suitably treated for protection against corrosion. The seating of the bar on the supports shall be designed in such a way that the bar may swing freely and without noise in all directions. The bar shall be secured against rotation around its longitudinal axis.

4.4 The bar shall allow turn and glide movements without slipping. The apparatus shall be stable. The supports shall not move or away during use. Preferably such materials should be used which guarantee a slim form and should not block the view. Neither the bar nor the tension cable shall produce disturbing sounds during use.

4.5 There shall be no protruding nails, projecting wire rope terminations or pointed or sharp-edged components. Rough surfaces should not present any risk of injury. All welds shall be smooth. Protruding bolt threads within any accessible part of the equipment shall be permanently covered, for example, dome headed nuts. Nuts and bolt heads that project less than 8 mm are permitted in non-

accessible parts, provided they are free from burrs. Corners, edges and projecting parts within the space occupied by the user that protrude more than 8 mm, and which are not shielded by adjacent areas that are not more than 25 mm from the end of the projecting part, shall be rounded off. The minimum radius of the curve shall be 3 mm. [Fig. 3](#) shows examples of protection for nuts and bolts and permissible protruding parts and [Fig. 4](#) shows examples of non-permissible protruding parts.

5 REQUIREMENTS

5.1 Materials

The bar shall be made of stainless steel of tensile strength not less than 1 200 N/mm². The tension rope used shall be steel wire rope tensile strength 1 100 N/mm² to 1 250 N/mm², conforming to IS 2365. The tubular used for supports shall be heavy grade galvanized mild steel tubing of minimum 40 mm diameter complying with IS 1239 (Part 2).

5.2 Shape and Dimension

A typical shape of horizontal bar is shown in [Fig. 5](#). The dimensions not specified are left to the discretion of the manufacturer.

5.3 Colour

The bar shall retain the colour of natural polished steel. Colours or designs of the remaining parts are left to the discretion of the manufacturer.

6 PERFORMANCE TEST REQUIREMENTS

6.1 Static Traction Stress Test

Horizontal bar shall be tested according to the procedures described in [Annex B](#). The measured

value of deflection shall be between 80 mm to 100 mm.

6.2 Pendulum Swing Stress Test

Horizontal bar shall be tested according to the procedures described in [Annex C](#), the mean values of the measured variables shall be within the figures of [Table 1](#).

6.3 Oscillation Damping Test

When tested according to the procedures described in [Annex D](#), the mean values of the measured variables shall be within the figures of [Table 2](#).

7 PACKING AND MARKING

7.1 Packing

The horizontal bar shall be packed as agreed to between the purchaser and the supplier.

7.2 Marking

7.2.1 The horizontal bar shall be marked with the followings:

- a) Manufacturer's name and trade-mark; and
- b) Month and year of manufacture.

7.2.2 BIS Certification Marking

The product(s) conforming to the requirements of this standard may be certified as per the conformity assessment schemes under the provisions of the *Bureau of Indian Standards Act, 2016* and the Rules and Regulations framed thereunder, and the product(s) may be marked with the Standard Mark.

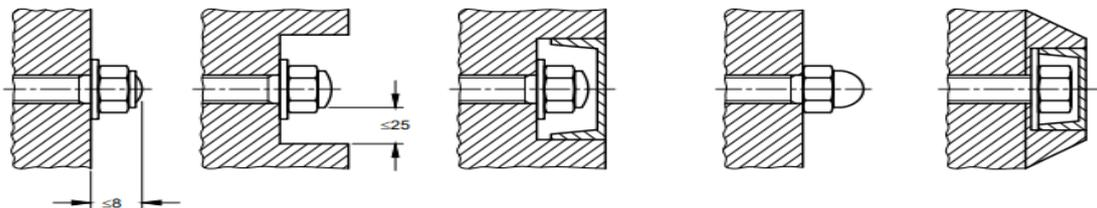

FIG. 3A EXAMPLE OF PROTECTION FOR NUTS AND BOLTS



FIG. 3B EXAMPLE OF PERMISSIBLE PROTRUDING PARTS

All dimensions are in millimetres.

FIG. 3 EXAMPLES OF PERMISSIBLE PARTS

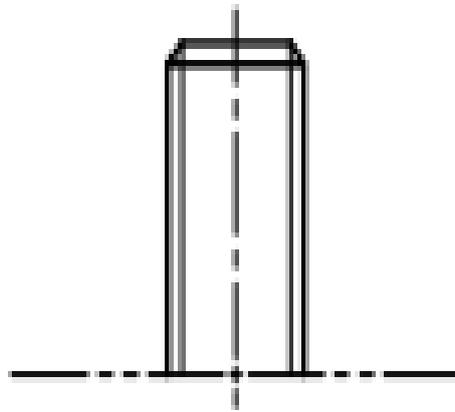

FIG. 4A UNCOVERED PROTRUDING EXTERIOR THREAD



FIG. 4B UNPROTECTED, OVERHANGING SHARP-EDGES (HARD) EQUIPMENT PART

All dimensions are in millimetres.

FIG. 4 EXAMPLES OF NON-PERMISSIBLE PROTRUDING PARTS

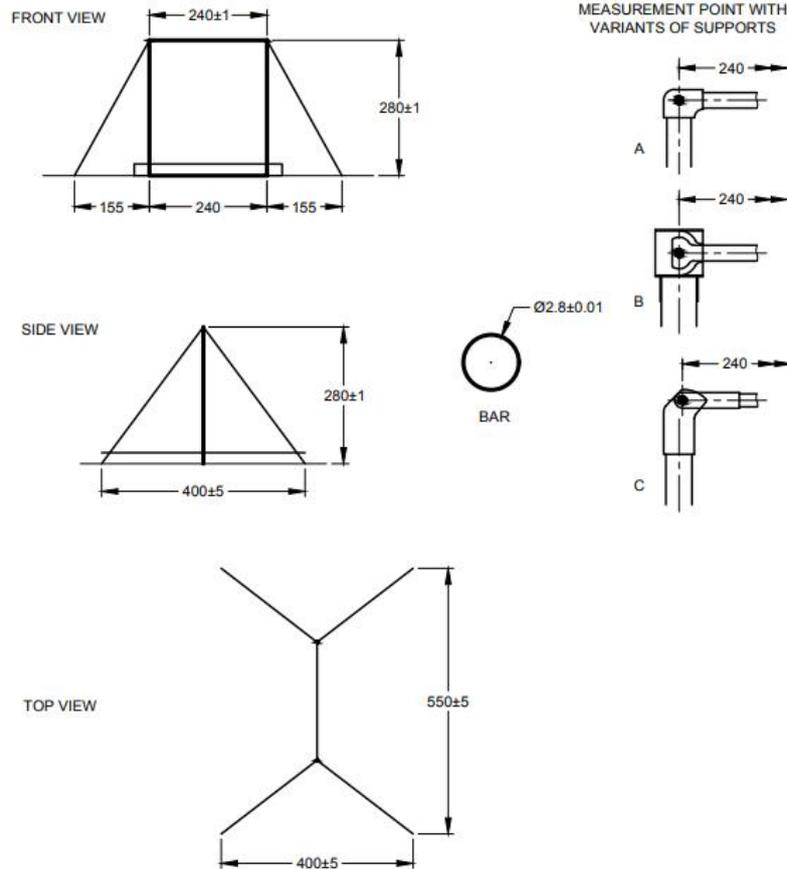

All dimensions are in cm
 FIG. 5 HORIZONTAL BAR

Table 1 Requirements for Pendulum Swing Stress Test

(Clause 6.2)

SI No.	Elasticity and Shock Absorption of Balance Beam	Values
(1)	(2)	(3)
i)	F_{\max} , N	$x \leq 3\ 200$
ii)	Positive vertical deflection, mm	$110 \leq x \leq 125$
iii)	Negative horizontal deflection, mm	$-42 \leq x \leq -32$
iv)	Positive horizontal deflection, mm	$56 \leq x \leq 71$

NOTE — 'x' represents the mean value of the measured variable.

Table 2 Requirements for Oscillation Damping Test

(Clauses 6.3 and D-5.10)

SI No.	Elasticity and Shock Absorption of Balance Beam	Values
(1)	(2)	(3)
i)	Frequency of oscillation, Hz	$3.00 \leq x \leq 3.25$
ii)	Half amplitude interval, ms	$1\ 250 \leq x \leq 4\ 900$

NOTE — 'x' represents the mean value of the measured variable.

ANNEX A

(Clauses [B-4](#), [C-4](#) and [D-4](#))

TEST SET-UP AND APPARATUS

A-1 TEST SET-UP FOR STATIC TRACTION STRESS TEST

Any type of test set-up is acceptable that is capable to stress the test specimen under prescribed conditions and monitoring and recording the displacement-time history of the midpoint of the bar.

A-2 TEST SET-UP FOR PENDULUM SWING STRESS TEST

Any type of test set-up is acceptable that is capable of stressing the test specimen with a pendulum swing under prescribed conditions and monitoring and recording the displacement - time history of the midpoint of the bar and the reaction force-time history of the pendulum. It is optional, but desirable, that the pendulum is released from a magnet in the horizontal position.

A-3 TEST SET-UP FOR OSCILLATION DAMPING TEST

Any type of test set-up is acceptable that is capable of stressing a bar-pendulum system under prescribed conditions and monitoring and recording the displacement-time history of the midpoint of the bar. It is optional, but desirable, that the bar-pendulum system is released from a magnet at the prescribed initial tension.

A-4 PENDULUM

The pendulum shall meet the following criteria:

A-4.1 Mass and Geometry

The tubular test body shall have a mass of (40.0 ± 1.2) kg (including load cells, grasping arms and appliances for additional weights) and a geometry as specified in [Fig. 6](#). All the dimensions shall have tolerance of 3 percent. The load cells shall be located between the test body and the grasping arms. The weight of each grasping arm shall be (1.0 ± 0.03) kg.

A-4.2 Added Weights

For pendulum swing stress test, two customary $10.0 \text{ kg} \pm 0.1 \text{ kg}$ dumb-bell weights shall be added with the help of specific appliances to each side of the pendulum, for an additional weight on the pendulum of $20.0 \text{ kg} \pm 0.2 \text{ kg}$. See [Fig. 6](#) for the location of the specific appliances. All the dimensions shall have tolerance of 3 percent.

A-4.3 Pendulum Fixation

The pendulum fixation to the bar shall meet the following criteria:

A-4.3.1 Functional Properties

The fixation shall allow an immediate transfer of forces between pendulum and bar and guarantee a low-friction rotation of the pendulum about the longitudinal axis of the bar (the use of roll bearings is recommended).

A-4.3.2 Friction of the Bar-Pendulum Fixation

The frictional properties of the fixation shall meet the following criteria:

- a) The time for the pendulum (80 kg, that is, 40 kg pendulum with additional 20 kg falling weight at the inside bottom [no internal drop height) and 20 kg added weights] to swing from horizontal position (release) through hanging (vertical) position shall be $680 \text{ ms} \pm 15 \text{ ms}$.

A-4.4 Additional Falling Weight

The additional falling weight shall meet the following criteria:

A-4.4.1 Mass and Geometry

The cylindrical falling weight shall have a mass of (20.0 ± 0.2) kg and a geometry as specified in [Fig. 7](#). All the dimensions shall have tolerance of 3 percent

A-4.4.2 Friction within the Tube of the Test Body

The frictional properties of the additional falling weight shall meet the following criteria:

- a) The time for the additional falling weight to cover the internal drop height of 90 cm by a pendulum swing (80 kg) down from horizontal position (release) shall be $640 \text{ ms} \pm 10 \text{ ms}$.

A-4.4.3 Damping of the Additional Falling Weight at the Inside Bottom of the Tubular Test Body

The damping properties of the additional falling weight shall meet the following criteria: The additional falling weight (20 kg) shall produce an

average peak force of $(5\ 800 \pm 1\ 500)$ N over 15 impact tests inside the tubular test body with a vertical drop height of (50 ± 1) mm. A chloroprene rubber at the bottom of the test body with a thickness of 8 mm, a density of 1.40 g/cm^3 and a tensile strength of 5.5 MPa is recommended.

A-5 RECORDING EQUIPMENT

A-5.1 Displacement-Time

The selection of the specific displacement - time recording equipment, including transducers and recorders, is at the discretion of the test laboratory. However, the transducers shall provide linear signals proportional to the two-dimensional displacement of the midpoint of the bar. If displacement is recorded, the test equipment shall have means to determine and record the starting position of the bar from which the total deflections are determined. The total system, detection and

recording, shall be capable of measuring displacements of up to 200 mm at frequencies from 2 Hz to 200 Hz to an accuracy of ± 1 percent. The minimum sampling rate of the data acquisition system shall be 500 Hz.

A-5.2 Reaction Force-Time

Any reaction force-time recording equipment, including load cells and recorders, which can monitor the reaction force exerted on the pendulum simultaneously with the displacement - time trace is acceptable. The total system, detection and recording, shall be capable of measuring reaction forces of up to 5 000 N at frequencies from 2 Hz to 200 Hz to an accuracy of ± 1 percent. The minimum sampling rate of the data acquisition system shall be 500 Hz.

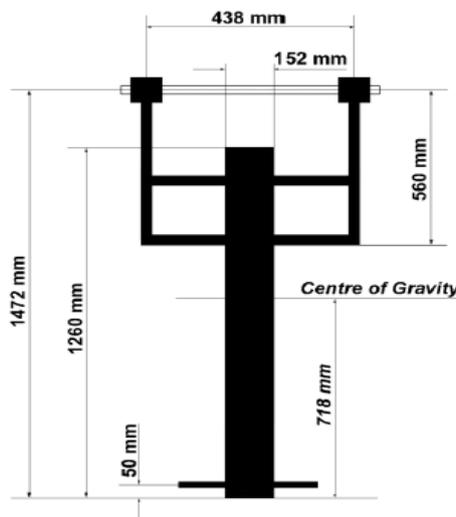

FIG. 6 PENDULUM DIMENSIONS

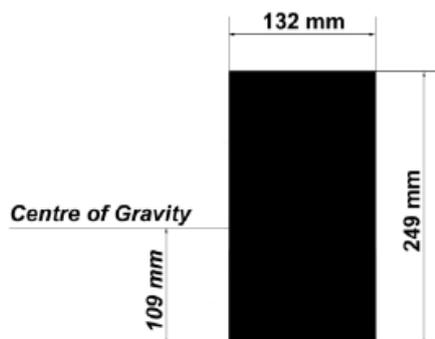

FIG. 7 GEOMETRY OF ADDITIONAL FALLING LOAD

ANNEX B*(Clause 6.1)***STATIC TRACTION STRESS TEST****B-1 TEST PRINCIPLE**

A bar of a mounted apparatus is pulled vertically downwards with a predetermined static tractive force. A measuring device mounted on the bar monitors the displacement-time history of the midpoint of the bar caused by this force. The maximum deflection is recorded with the aid of a data acquisition system. After the release of the static tractive force the bar must return into the starting position.

B-2 TEST SPECIMEN

The test specimen submitted for testing shall consist of a complete horizontal bar as it is intended to be used during training and/or competition.

B-3 CONDITIONING AND TEST TEMPERATURE

The horizontal bar, mounted and assembled for use, shall be preconditioned at 50 percent \pm 10 percent relative humidity and (27 ± 3) °C for a minimum of 24 h prior to the test. All testing shall be carried out under the same conditions.

B-4 TEST APPARATUS

Refer to [Annex A](#).

B-5 TEST PROCEDURE

B-5.1 Mount the bar to a height as prescribed for competitions.

B-5.2 The default cable tension shall be 1 500 N \pm 50 N provided that there is no other specific cable tension suggested by the manufacturer. If a specific cable tension is suggested by the manufacturer, then this suggested cable tension shall be used.

B-5.3 Install the displacement measuring device on an unloaded bar and determine the starting position.

B-5.4 Pull the midpoint of the bar vertically downwards with a static tractive force of 2 200 N \pm 20 N and capture, then record the resulting maximum deflection (mm) using recording equipment described in [A-5](#).

B-5.5 After the release of the static tractive force verify whether the bar returns into the starting position.

ANNEX C*(Clause 6.2)***PENDULUM SWING STRESS TEST****C-1 TEST PRINCIPLE**

A pendulum which is attached to the bar of a mounted apparatus is rotated from hanging position into horizontal position and then released. While it swings down, an additional falling weight inside the tubular pendulum slides down from a predetermined internal drop height until the weight strikes against the inside bottom of the pendulum, producing an additional impact stress on the gymnastic apparatus. A measuring device monitors the two-dimensional displacement - time history of the midpoint of the bar. Load cells inside both pendulum grasping arms monitor the reaction force - time history of the pendulum. Both are recorded with the aid of a data acquisition system. The test measures the maximum reaction force in the direction of the pendulum's centre of gravity as well as the positive deflection of

the bar in vertical direction and the positive and negative deflection of the bar in horizontal direction.

C-2 TEST SPECIMEN

Refer to [B-2](#).

C-3 CONDITIONING AND TEST TEMPERATURE

Refer to [B-3](#).

C-4 TEST APPARATUS

Refer to [Annex A](#).

C-5 TEST PROCEDURE

C-5.1 Mount the bar to a height as prescribed for competitions.

C-5.2 The default cable tension shall be 1 500 N \pm 50 N provided that there is no other specific cable tension suggested by the manufacturer. If a specific cable tension is suggested by the manufacturer, then this suggested cable tension shall be used.

C-5.3 Install the displacement measuring device on the unloaded bar and determine the starting position.

C-5.4 Attach the pendulum (80 kg, that is, 40 kg pendulum with additional 20 kg falling weight) to a bar in hanging position.

C-5.5 Move the pendulum from hanging position into horizontal position and move the additional falling weight inside the pendulum to the 90 cm \pm 1 cm internal drop height position.

C-5.6 Release the pendulum and capture the two-dimensional displacement-time history of the midpoint of the bar or the bar linkage and the reaction force - time history of the pendulum, using recording equipment described in [A-5](#).

C-5.7 Stress the horizontal bar by repeating the pendulum swing five times.

C-5.8 Immediately following each test, record the maximum force, F_{\max} (N) and positive vertical deflection (mm), as well as positive and negative horizontal deflection (mm).

C-5.9 All five tests shall be used to determine the arithmetic mean values of the measured variables.

ANNEX D

[\(Clause 6.3\)](#)

OSCILLATION DAMPING TEST

D-1 TEST PRINCIPLE

A pendulum which is attached to the bar of a mounted apparatus is pulled vertically downwards until a predetermined initial tension is reached. The abrupt release causes a damped oscillation of the bar-pendulum system. A measuring device monitors the displacement-time history of the midpoint of the bar which is recorded with the aid of a data acquisition system. The test measures the frequency as well as the half amplitude interval of the oscillation.

D-2 TEST SPECIMEN

Refer to [B-2](#).

D-3 CONDITIONING AND TEST TEMPERATURE

Refer to [B-3](#).

D-4 TEST APPARATUS

Refer to [Annex A](#).

D-5 TEST PROCEDURE

D-5.1 Mount the bar to a height as prescribed for competitions.

D-5.2 The default cable tension shall be 1 500 N \pm 50 N provided that there is no other specific cable tension suggested by the manufacturer. If a specific

cable tension is suggested by the manufacturer, then this suggested cable tension shall be used.

D-5.3 Install the displacement measuring device on the unloaded bar and determine the starting position.

D-5.4 Attach the pendulum (60 kg, that is, 40 kg pendulum with additional 20 kg falling weight at the inside bottom of the pendulum) to a bar (tests in lateral test direction) or the bar linkage (tests in transversal test direction) in hanging position.

D-5.5 Pull down the pendulum vertically until the initial tension of 1 000 N \pm 30 N is reached.

D-5.6 Release the pendulum and capture the displacement - time history of the midpoint of the bar or the bar linkage using recording equipment described in [A-5](#).

D-5.7 Repeat the above process five times.

D-5.8 Immediately record the frequency (Hz) and half amplitude interval (ms) of the oscillation.

D-5.9 All five tests per test position shall be used to determine the arithmetic mean values of the measured variables for each bar.

D-5.10 Calculate the values of all required variables as given in [Table 2](#), rounded to the decimal places.

ANNEX E

(Foreword)

COMMITTEE COMPOSITION

Sports Goods Sectional Committee, PGD 41

<i>Organization</i>	<i>Representative(s)</i>
Sports Goods Export Promotion Council, New Delhi	SHRI TARUN DEWAN (<i>Chairperson</i>)
All India Lawn Tennis Association, New Delhi	SHRI ZEESHAN ALI SHRI VIVEK SHARMA (<i>Alternate I</i>) SHRI VINIT PUNDIR (<i>Alternate II</i>)
Anand & Anand, Jalandhar	SHRI ASHISH ANAND
Athletic Federation of India, New Delhi	SHRI SANDEEP MEHTA SHRI GOPALA KRISHNAN (<i>Alternate</i>)
Bhalla International Vinex, Meerut	SHRI SANJAY BHALLA
Central Institute of Plastics Engineering & Technology (CIPET), Murthal	SHRI K. A. RAJESH SHRI VIVEK KUMAR (<i>Alternate</i>)
COSCO India Pvt Ltd, Gurgaon	SHRI PANKAJ JAIN SHRI AMIT JAIN (<i>Alternate</i>)
Freewill Sports Pvt Ltd, Jalandhar	SHRI RAJESH KHARBANDA
Government e Market Place, New Delhi	MS DEEPIKA SHOKEEN SHRI ABHISHEK KAKKAR (<i>Alternate</i>)
Gymnastic Federation of India, Mumbai	SHRI RIAZ BHATI
Micro, Small and Medium Enterprises, Technology Development Centre, New Delhi	SHRI ADITYA PRAKASH SHARMA SHRI V. K. SINGH (<i>Alternate</i>)
NELCO (India) Pvt Ltd, Meerut	SHRI AMBER ANAND
Premier Leg Guard Works, Meerut	SHRI SUMESH AGARWAL SHRI KSHITIJ AGARWAL (<i>Alternate</i>)
Ranson Sports Industry, Jalandhar	SHRI ARVIND SINGH RANA
Sanspareils Greenlands Pvt Ltd, Meerut	SHRI PUNEET ANAND SHRI PUNEET ARORA (<i>Alternate</i>)
SGS India Private Limited, Mumbai	SHRI AMIT SALUJA SHRI SAILESH SHARMA (<i>Alternate</i>)
Shri Ram Institute For Industrial Research, Delhi	MS ARCHANA BISHT SHRI (DR) MANMOHAN KUMAR
Soccer International Pvt Ltd, Jalandhar	MS SHAALINI GUPTA

<i>Organization</i>	<i>Representative(s)</i>
Softball Association of India, New Delhi	MS SHIBANI TAGORE
Sports and Toys Exporters Association, Jalandhar	SHRI NITIN MAHAJAN
Sports Authority of India, New Delhi	SHRI K. C. MEENA SHRI VISHNUBHTLA SHARMA (<i>Alternate</i>)
Sports Goods Manufacturers and Exporters Association (SGMEA), Jalandhar	SHRI VIPIN MAHAJAN
Stag International Sports, Meerut	SHRI RAKESH KOHLI SHRI VIVEK KOHLI (<i>Alternate</i>)
Universal Sports, Jalandhar	SHRI MAHESH CHADHA
Voluntary Organisation in Interest of Consumer Education (Voice), New Delhi	SHRI M. A. U. KHAN
Yonker Skates Private Limited, Delhi	SHRI OJASVI NAGPAL
BIS Directorate General	SHRI R. R. SINGH, SCIENTIST 'F'/SENIOR DIRECTOR AND HEAD (PRODUCTION AND GENERAL ENGINEERING) [REPRESENTING DIRECTOR GENERAL (<i>Ex-officio</i>)]

Member Secretary
SHRI AJAY KUMAR
SCIENTIST 'B'/ASSISTANT DIRECTOR
(PRODUCTION AND GENERAL ENGINEERING), BIS

Bureau of Indian Standards

BIS is a statutory institution established under the *Bureau of Indian Standards Act, 2016* to promote harmonious development of the activities of standardization, marking and quality certification of goods and attending to connected matters in the country.

Copyright

BIS has the copyright of all its publications. No part of these publications may be reproduced in any form without the prior permission in writing of BIS. This does not preclude the free use, in the course of implementing the standard, of necessary details, such as symbols and sizes, type or grade designations. Enquiries relating to copyright be addressed to the Head (Publication & Sales), BIS.

Review of Indian Standards

Amendments are issued to standards as the need arises on the basis of comments. Standards are also reviewed periodically; a standard along with amendments is reaffirmed when such review indicates that no changes are needed; if the review indicates that changes are needed, it is taken up for revision. Users of Indian Standards should ascertain that they are in possession of the latest amendments or edition by referring to the website-www.bis.gov.in or www.standardsbis.in.

This Indian Standard has been developed from Doc No.: PGD 41 (21782).

Amendments Issued Since Publication

Amend No.	Date of Issue	Text Affected

BUREAU OF INDIAN STANDARDS

Headquarters:

Manak Bhavan, 9 Bahadur Shah Zafar Marg, New Delhi 110002

Telephones: 2323 0131, 2323 3375, 2323 9402

Website: www.bis.gov.in

Regional Offices:

Central : 601/A, Konnectus Tower -1, 6th Floor,
DMRC Building, Bhavbhuti Marg, New
Delhi 110002

Telephones

{ 2323 7617

Eastern : 8th Floor, Plot No 7/7 & 7/8, CP Block, Sector V,
Salt Lake, Kolkata, West Bengal 700091

{ 2367 0012
{ 2320 9474

Northern : Plot No. 4-A, Sector 27-B, Madhya Marg,
Chandigarh 160019

{ 265 9930

Southern : C.I.T. Campus, IV Cross Road, Taramani, Chennai 600113

{ 2254 1442
{ 2254 1216

Western : 5th Floor/MTNL CETTM, Technology Street, Hiranandani Gardens, Powai
Mumbai 400076

{ 25700030
{ 25702715

Branches : AHMEDABAD, BENGALURU, BHOPAL, BHUBANESHWAR, CHANDIGARH, CHENNAI, COIMBATORE, DEHRADUN, DELHI, FARIDABAD, GHAZIABAD, GUWAHATI, HARYANA (CHANDIGARH), HUBLI, HYDERABAD, JAIPUR, JAMMU, JAMSHEDPUR, KOCHI, KOLKATA, LUCKNOW, MADURAI, MUMBAI, NAGPUR, NOIDA, PARWANOO, PATNA, PUNE, RAIPUR, RAJKOT, SURAT, VIJAYAWADA.