

धात्विक सामग्री — श्रान्ति परीक्षण —
अक्षीय-तनाव-नियंत्रण पद्धति
(ISO 12106 : 2017, संशोधित)

**Metallic Materials — Fatigue Testing —
Axial-Strain-Controlled Method**
(ISO 12106 : 2017, MOD)

ICS 77.040.10

© BIS 2024
© ISO 2017



भारतीय मानक ब्यूरो
BUREAU OF INDIAN STANDARDS
मानक भवन, 9 बहादुर शाह जफर मार्ग, नई दिल्ली - 110002
MANAK BHAVAN, 9 BAHADUR SHAH ZAFAR MARG
NEW DELHI - 110002
www.bis.gov.in www.standardsbis.in

September 2024

Price Group 14

NATIONAL FOREWORD

This Indian Standard which was a modified adoption of ISO 12106 : 2017 'Metallic materials — Fatigue testing — Axial-strain-controlled method' issued by the International Organization for Standardization (ISO), was adopted by the Bureau of Indian Standards on the recommendation of Mechanical Testing of Metals Sectional Committee and approval of the Metallurgical Engineering Division Council.

The portions given in dotted underlines are the matters not specified in the corresponding International Standard. A list of technical modifications is given in [National Annex C](#).

Materials and their microstructure may change when subjected to cyclic deformations and their mechanical properties can be significantly altered when compared with that resultant from monotonic deformations, for example, uniaxial stress-strain response. The design of mechanical components subjected to fatigue loadings and cyclic deformations requires, in a number of industrial sectors (that is, nuclear, aerospace, ground vehicles, medical devices, etc), knowledge of the cyclic behaviour of the materials under reversed strain control conditions, referred to as low-cycle fatigue, when cyclic plasticity is present.

In order to ensure reliability and consistency of results from different laboratories, it is necessary to collect all data using test methodologies that comply with a number of key points.

This document concerns both the generation of such strain-controlled fatigue data at room or elevated temperatures at fixed R -ratios (strain) and the presentation of results for fatigue properties, strain-life behaviour and cyclic stress-strain responses of metallic materials determined at an R_e -ratio = -1. Since there is a close relationship with strain-controlled, high-temperature testing, there is also a section devoted to creep-fatigue testing methodology.

This document does not address safety or health concerns, should such issues exist, that may be associated with its use or application. The user of this document has the sole responsibility to establish any appropriate safety and health concerns, as well as to determine the applicability of any national or local regulatory limitations regarding the use of this document.

Except the deviations identified in [National Annex C](#), the remaining text of the ISO standard has been approved as suitable for publication as an Indian Standard without deviations. Certain conventions and terminologies are, however, not identical to those used in Indian Standards. Attention is particularly drawn to the following:

- a) Wherever the words 'International Standard' appear referring to this standard, it should be read as 'Indian Standard'; and
- b) Comma (,) has been used as a decimal marker while in Indian Standards the current practice is to use a point (.) as the decimal marker.

In this adopted standard, reference appears to certain International Standards for which Indian Standards also exist. The corresponding Indian Standards which are to be substituted in their place are listed below along with their degree of equivalence for the edition indicated:

<i>International Standard</i>	<i>Corresponding Indian Standard</i>	<i>Degree of Equivalence</i>
ISO 7500-1 Metallic materials — Calibration and verification of static uniaxial testing machines — Part 1: Tension/compression testing machines — Calibration and verification of the force-measuring system	IS 1828 (Part 1) : 2022/ISO 7500-1 : 2018 Metallic materials — Calibration and verification of static uniaxial testing machines — Part 1: Tension/Compression testing machines — Calibration and verification of the force-measuring system (<i>fifth revision</i>)	Identical

[\(Continued to third cover\)](#)

Contents

Page

Introduction	v
1 Scope	1
2 Normative references	1
3 Terms and definitions	1
4 Symbols	3
4.1 Specimens.....	3
4.2 Fatigue testing.....	3
4.2.1 Symbols.....	3
4.2.2 Subscripts.....	5
4.3 Expression of results.....	5
5 Apparatus	5
5.1 Test machine.....	5
5.1.1 General.....	5
5.1.2 Force transducer.....	6
5.1.3 Gripping of specimen.....	6
5.1.4 Alignment check.....	6
5.2 Strain measurement.....	7
5.3 Heating device and temperature measurement.....	8
5.4 Instrumentation for test monitoring.....	8
5.4.1 Recording systems.....	8
5.4.2 Cycle counter.....	9
5.5 Checking and verification.....	9
6 Specimens	9
6.1 Geometry.....	9
6.1.1 Round bars.....	9
6.1.2 Flat sheet products.....	10
6.2 Preparation of specimens.....	14
6.2.1 General.....	14
6.2.2 Machining procedure.....	14
6.2.3 Sampling and marking.....	15
6.2.4 Surface condition of specimen.....	15
6.2.5 Dimensional check.....	16
6.2.6 Storage and handling.....	16
7 Procedure	16
7.1 Laboratory environment.....	16
7.2 Test machine control.....	16
7.3 Mounting of the specimen.....	17
7.4 Cycle shape — Strain rate or frequency of cycling.....	17
7.5 Start of test.....	18
7.5.1 Preliminary measurements.....	18
7.5.2 Test commencement.....	19
7.6 Number of specimens.....	19
7.7 Data recording.....	19
7.7.1 Stress-strain hysteresis loops.....	19
7.7.2 Data acquisition.....	19
7.8 End of test.....	20
7.9 Failure criteria.....	20
8 High-temperature strain-controlled creep-fatigue testing	22
9 Expression of results	23
9.1 Basic data (recorded data (see 7.7)).....	23

9.2	Analysis of low-cycle fatigue results at $R_e = -1$	23
9.2.1	Distinction between different types of strain values.....	23
9.2.2	Determination of fatigue life (see 7.9).....	24
9.2.3	Stress-strain and strain-fatigue life relationships.....	24
9.3	Analysis of creep-fatigue results.....	25
10	Test report	25
10.1	General.....	25
10.2	Purpose of the test.....	26
10.3	Material.....	26
10.4	Specimen.....	26
10.5	Test methods.....	26
10.6	Test conditions.....	27
10.7	Presentation of results.....	27
10.7.1	Presentation of single test results.....	27
10.7.2	Presentation of results of test series.....	28
10.8	Values to be stored in a low-cycle fatigue database.....	29
Annex A (informative) Measurement uncertainty		31
Annex B (informative) Examples of graphical presentation of results		33
National Annex C (National Foreword)		37
Bibliography		38

Introduction

Materials and their microstructure may change when subjected to cyclic deformations and their mechanical properties can be significantly altered when compared with that resultant from monotonic deformations, for example, uniaxial stress-strain response. The design of mechanical components subjected to fatigue loadings and cyclic deformations requires, in a number of industrial sectors (i.e. nuclear, aerospace, ground vehicles, medical devices, etc.), knowledge of the cyclic behaviour of the materials under reversed strain control conditions, referred to as low-cycle fatigue, when cyclic plasticity is present.

In order to ensure reliability and consistency of results from different laboratories, it is necessary to collect all data using test methodologies that comply with a number of key points.

This document concerns both the generation of such strain-controlled fatigue data at room or elevated temperatures at fixed R -ratios (strain) and the presentation of results for fatigue properties, strain-life behaviour and cyclic stress-strain responses of metallic materials determined at an R_e -ratio = -1 . Since there is a close relationship with strain-controlled, high-temperature testing, there is also a section devoted to creep-fatigue testing methodology.

This document does not address safety or health concerns, should such issues exist, that may be associated with its use or application. The user of this document has the sole responsibility to establish any appropriate safety and health concerns, as well as to determine the applicability of any national or local regulatory limitations regarding the use of this document.

Indian Standard

METALLIC MATERIALS — FATIGUE TESTING — AXIAL-STRAIN-CONTROLLED METHOD

(ISO 12106 : 2017, MOD)

1 Scope

This document specifies a method of testing uniaxially deformed specimens under strain control at constant amplitude, uniform temperature and fixed strain ratios including at $R_e = -1$ for the determination of fatigue properties. It can also be used as a guide for testing under other R -ratios, as well as elevated temperatures where creep deformation effects may be active.

2 Normative references

The following documents are referred to in the text in such a way that some or all of their content constitutes requirements of this document. For dated references, only the edition cited applies. For undated references, the latest edition of the referenced document (including any amendments) applies.

ISO 7500-1, *Metallic materials — Calibration and verification of static uniaxial testing machines — Part 1: Tension/compression testing machines — Calibration and verification of the force-measuring system*

ISO 9513, *Metallic materials — Calibration of extensometer systems used in uniaxial testing*

ISO 23788, *Metallic materials — Verification of the alignment of fatigue testing machines*

3 Terms and definitions

For the purposes of this document, the following terms and definitions apply.

ISO and IEC maintain terminological databases for use in standardization at the following addresses:

- IEC Electropedia: available at <http://www.electropedia.org/>
- ISO Online browsing platform: available at <http://www.iso.org/obp>

3.1 engineering stress

instantaneous force divided by the initial cross-sectional area of the gauge length

$$S = F / A_0$$

3.2 true stress

instantaneous force divided by the instantaneous cross-sectional area of the gauge length

$$\sigma = F / A$$

Note 1 to entry: At strains to approximately 10 %, the true stress is approximated by the engineering stress, F/A_0 . It is also important to note that at strains to approximately 10 %, it is the engineering strain that is actually measured by the extensometer and it is the controlled parameter in a test.

3.3 initial length gauge length

L_0
initial length between extensometer measurement points at test temperature

**3.4
parallel length**

L_p
length between transition radii of the test specimen

**3.5
strain**
engineering strain

$$e = \frac{\Delta L}{L_0} = \frac{L_i - L_0}{L_0}$$

true total strain

$$\varepsilon = \int_{L_0}^{L_i} \frac{dL}{L}$$

where

L_i is the instantaneous length of the gauge section;

L_0 is the initial or gauge length.

Note 1 to entry: At true strain values to approximately 10 %, ε is approximated by the engineering strain $e = \Delta L/L$. It is also important to note that at strains to approximately 10%, it is the engineering strain that is the quantity measured by the extensometer and the controlled parameter in a strain-controlled fatigue test.

**3.6
cycle**
smallest segment of the strain-time function that is repeated periodically

**3.7
maximum**
greatest algebraic value of a variable within one cycle

**3.8
minimum**
least algebraic value of a variable within one cycle

**3.9
mean**
one-half of the algebraic sum of the maximum and minimum values of a variable

**3.10
range**
algebraic difference between the maximum and minimum values of a variable

**3.11
amplitude**
half the range of a variable

**3.12
fatigue life**
 N_f
number of cycles that have to be applied to achieve a failure

Note 1 to entry: Failure criteria are defined, for example, in [7.8](#). The failure criterion used shall be reported with the results and be consistent through a series of fatigue tests.

3.13

hysteresis loop

closed curve of the stress-strain response during one complete cycle

Note 1 to entry: It is quite common that the beginning few hysteresis loops in a test sequence may not be completely “closed” due to cyclic softening, cyclic hardening, cyclic stress relaxation, stress “shakedown”, or ratchetting.

4 Symbols

For the purposes of this document, the symbols defined in [4.1](#) to [4.3](#) apply.

4.1 Specimens

See [Table 1](#).

Table 1 — Symbols and designations concerning specimens

Specimen	Symbol	Designation	Unit
	L_0	Initial or gauge length	mm
	L_i	Instantaneous gauge length	mm
	A_0	Initial area of gauge section	mm ²
	A	Instantaneous area of gauge section with $AL = A_0L_0$	mm ²
	A_f	Minimum area at failure	mm ²
	r	Transition radius (from parallel length into the grip end of the test specimen)	mm
	L_z	Overall length of specimen	mm
Cylindrical			
	d	Diameter of cylindrical gauge section	mm
	D	Diameter of grip end of specimen	mm
Flat-sheet			
	t	Thickness	mm
	W	Width of grip end	mm
	w	Width of gauge section	mm

4.2 Fatigue testing

4.2.1 Symbols

Table 2 — Symbols and designations for variables and properties

Symbol	Definition	Units
E	Modulus of Elasticity mean value of the slope of the initial linear portion of a stress- strain curve	Gigapascals (GPa)
E_T	unloading modulus following a maximum stress (see Figure 1),	Gigapascals (GPa)
E_C	unloading modulus following a min- imum stress (see Figure 1)	Gigapascals (GPa)
N_f	number of cycles to failure	

Table 2 (continued)

Symbol	Definition	Units
t_f	time to failure; $t_f = T \cdot N_f$ in which T is the period of the signal (duration of the wavelength)	Seconds (s)
σ	true stress	Megapascals (MPa)
S	engineering stress	Megapascals (MPa)
e	engineering strain	
$\dot{e} = \frac{de}{dt}$	strain rate	Seconds to the power of minus one (s^{-1}) where t = time
ϵ	true strain	
Δ	range of a variable	
R_z	mean surface roughness	Micrometres (μm)
R_e	strain ratio = $(e_{\text{min}}/e_{\text{max}})$	

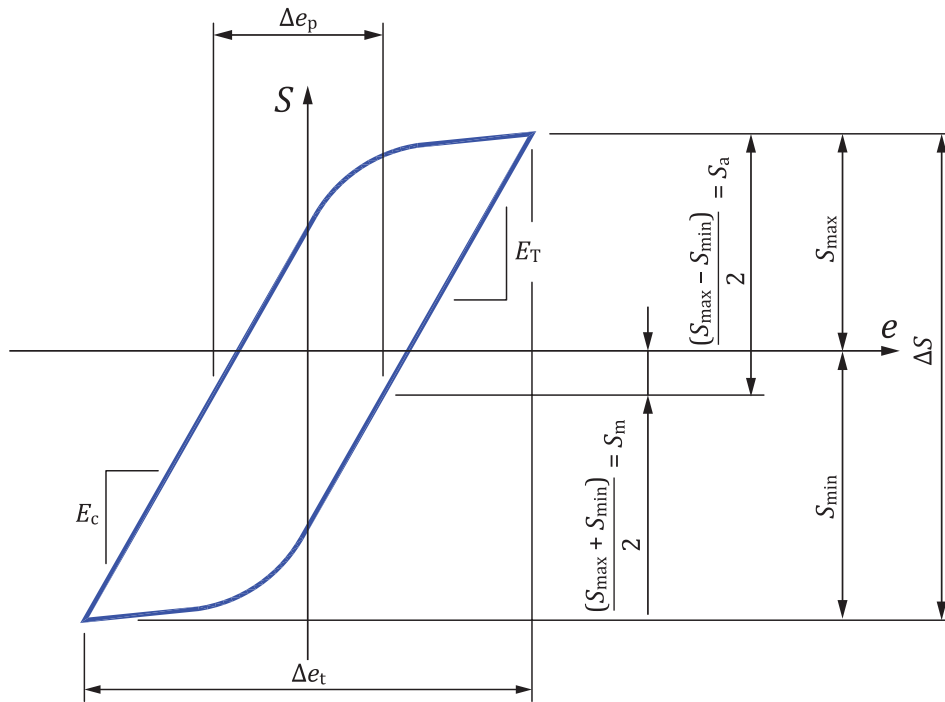

Figure 1 — Stress-strain hysteresis loop at $R_e = -1$

NOTE For the purpose of defining plastic strain from a stabilized stress-strain hysteresis loop, it is that non-recoverable strain at the mean stress established by $(S_{\max} + S_{\min})/2$ for the steady-state stress response in a controlled strain test. Frequently, it is the width of the hysteresis loop at zero stress crossing but it may not be in some metals.

4.2.2 Subscripts

Table 3 — Subscripts and meaning

Subscript	Meaning
t	total
p	plastic
e	elastic
a	amplitude
m	mean
min	minimum
max	maximum

4.3 Expression of results

See [Table 4](#).

Table 4 — Symbols and designations concerning the expression of fatigue properties for $R_e = -1$ tests

Symbol	Designation	Unit
$\sigma_{y'}$	Cyclic yield strength ^a	MPa
n	Monotonic strain hardening exponent	—
n'	Cyclic strain hardening exponent	—
K	Monotonic strength coefficient	MPa
K'	Cyclic strength coefficient	MPa
$\sigma_{f'}$	Fatigue strength coefficient	MPa
b	Fatigue strength exponent	—
$\varepsilon_{f'}$	Fatigue ductility coefficient	—
c	Fatigue ductility exponent	—

^a 0,2 % offset is typically used.

5 Apparatus

5.1 Test machine

5.1.1 General

The tests shall be conducted on a uniaxial tension-compression machine designed for smooth start-up with no backlash when passing through zero stress. The machine shall be capable of controlling strain and measuring force when applying the recommended waveform. It should be axially stiff and well aligned. The complete machine-loading system, including force transducer and grips, should have sufficient lateral stiffness to avoid specimen buckling at the extremes of compressive stress.

NOTE See ISO 23788:2012, Annex C for a methodology for determination of lateral stiffness of a test machine.

5.1.2 Force transducer

The force transducer shall be designed for tensile-compressive fatigue tests and should have high axial and lateral stiffness. Its capacity shall be suitable for the forces applied during the test. The force transducer shall conform to ISO 7500-1:2015, Class 1.

The indicated force as recorded at the output from a computer in an automated system or from the final output recording device in any non-automated system shall be within the specified permissible variation from the actual force. The force transducer capacity shall be sufficient to cover the range of *dynamic* forces measured during a test. The force measuring system shall comply with ISO 7500-1:2015, Class 1.

The force transducer shall be temperature-compensated with temperature coefficient of zero and span shall be no greater than 0,002 % of full scale per degree Celsius. Further, temperature gradients in the force transducer should be avoided.

During high-temperature or cryogenic testing, suitable shielding/compensation may be provided for the cell so it is maintained within its compensation range.

5.1.3 Gripping of specimen

The gripping device shall transmit the cyclic forces to the specimen without backlash along its longitudinal axis. The overall load-string length should be minimized to avoid any tendency of the specimen to buckle. The geometric qualities of the device shall ensure correct alignment in order to meet the requirements specified in 5.1.4; it is therefore necessary to limit the number of components of which these gripping devices are composed and reduce the number of mechanical interfaces to a minimum.

The gripping device shall ensure the manner in which the specimen is mounted is reproducible. It shall have geometric features assuring the proper alignment of the specimen and preloaded surfaces allowing transmission of tensile and compressive forces without backlash throughout the duration of the test. Materials shall be selected so as to ensure correct functioning across the test temperature range.

5.1.4 Alignment check

Bending in a test machine due to misalignment in rigid-grip systems is generally caused by angular or lateral offsets of the grips or a combination of both (see [Figure 2](#)).

The test machine alignment shall be checked before each series of tests and any time a change is made to the load train in accordance with ISO 23788. The machine alignment shall be maximum of Class 5 according to ISO 23788.

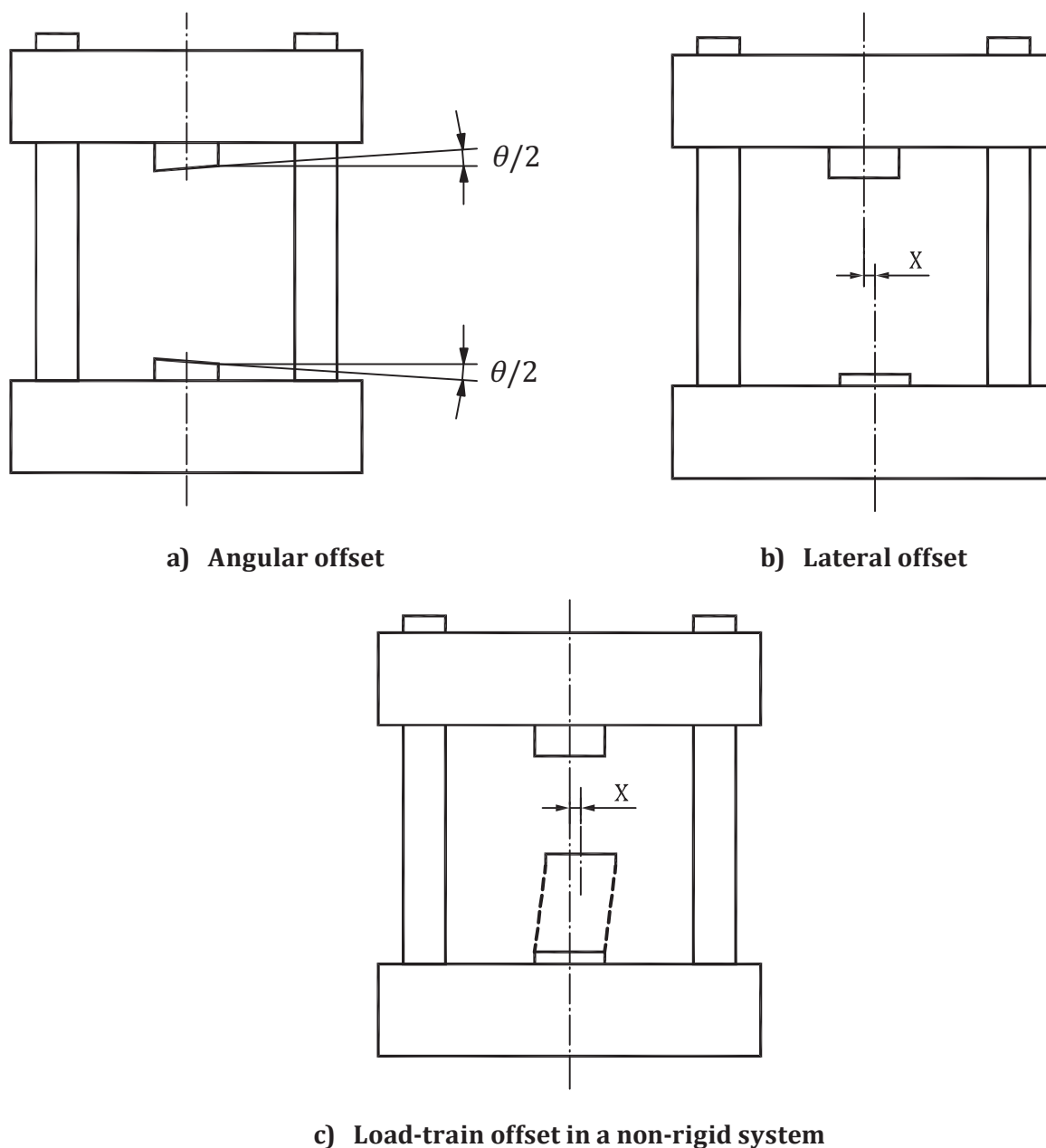

Figure 2 — Bending mechanisms due to misalignment in fatigue test systems

In a proper test machine/gripping procedure alignment procedure, it is the principles that are important since they shall:

- Ensure axial alignment of specimen and push/pull rods.
- Ensure mating faces of specimen and push/pull rods are parallel and square to the axis of symmetry.
- Ensure that the lateral stiffness of the load string and frame is sufficiently great enough to maintain axially when the specimen gauge length has become plastic (tangent modulus tending to zero).

5.2 Strain measurement

The strain shall be measured from the specimen using an axial extensometer.

The extensometer used shall be suitable for measuring dynamic strain over long periods during which there shall be minimal drift, slippage and instrument hysteresis. It shall measure directly the axial strain on the gauge section of the specimen.

The strain-measuring system, including the extensometer and its associated electronics, shall conform to ISO 9513:2012, Class 1.

The geometry of the contact zones and the pressure exerted by the extensometer on the specimen shall be such that they prevent slippage of the extensometer but do not damage the specimen.

The transducer section of the extensometer shall be protected from thermal fluctuations that give rise to potential drift, particularly at elevated temperatures.

5.3 Heating device and temperature measurement

NOTE See References [16], [20], [21] and [22].

A uniform rise in temperature shall be ensured without the test temperature being exceeded.

If a direct induction heating system is used, it is advisable to select a generator with a frequency sufficiently low to prevent “skin effects” on heating.

The heating device shall produce a temperature gradient not exceeding 3 °C over the gauge length of the specimen and shall ensure, throughout the test, and with due consideration to all combined sources of error, that deviations between the test temperature and that of the specimen are within $\pm 2,5^{\circ}\text{C}$.

These deviations shall be checked using three thermocouples or other appropriate devices, one at each end and one in the middle of the gauge length of the specimen.

In a test, the specimen temperature may be measured using thermocouples in contact with the specimen surface. Direct contact between the thermocouple and the specimen is necessary and shall be achieved without affecting the test results (e.g. crack initiation at the point of contact of the thermocouple shall be avoided). Commonly used methods of attaching the thermocouples are by binding in place, by pressure or by resistance spot welding.

The temperature shall be measured by at least one sensor independently of the one used for control purposes.

5.4 Instrumentation for test monitoring

5.4.1 Recording systems

It is common for low-cycle fatigue test equipment nowadays to be computer controlled and equipped with digital data acquisition systems. Basic software platforms provided in modern digital systems provide accurate test control, as well as report generation. They are typically equipped to provide real-time numerical displays in either the digital or analog domain of test data, as well as generation and storage of graphical and tabular test results.

In such a typical digital system, the sampling frequency of stress-strain data points shall be sufficient to ensure correct definition of the hysteresis loop, especially in the regions of strain reversal at hysteresis loop tips. However, different data collection strategies will affect the number of data points per loop needed. Typically, at least 50 points per loop are sufficient but 200 or more points per loop are highly recommended.

Since there are a number of analog systems still in use, the following shall be considered a minimum requirement for the analog recording of data:

- an X-Y recorder used to record stress-strain hysteresis loops;
- a recorder for several time-dependent parameters, e.g. force, strain and temperature;

- a peak-to-peak detector

5.4.2 Cycle counter

A cycle counter is essential for knowing the number of straining cycles. For the majority of the strain rates used, counters without multiplication factors should suffice.

5.5 Checking and verification

The test machine and its control and measurement systems shall be checked regularly.

Specifically:

Each transducer and its associated electronics shall always be checked as a unit:

- the force-measuring system(s) shall be verified in accordance with the relevant ISO or national standard;
- the strain-measuring system(s) shall be verified in accordance with the relevant ISO or national standard;
- the temperature-measuring system(s) shall be verified in accordance with the relevant ISO or national standard.

It is considered good engineering practice and testing protocol before each series of tests to check the gauge length of the extensometer, the force transducer and the extensometer calibration using a shunt resistor or alternate suitable method, and also to check the thermocouple or pyrometer calibration.

6 Specimens

6.1 Geometry

6.1.1 Round bars

The gauge portion of the specimen in a low-cycle fatigue test should represent a volume element of the material under study, which implies that the geometry of the specimen shall not affect the use of the test results.

This geometry shall fulfil the following conditions:

- provide a uniform cylindrical gauge portion;
- minimize the risk of buckling in compression to avoid failure initiation at the transition radius;
- provide a uniform strain distribution over the whole gauge portion;
- allow the extensometer to measure the strain without interference or slippage.

The parallel-sided length of the specimen shall be longer than the extensometer gauge length. However, to reduce the risk of failure outside the extensometer gauge length, the parallel length L_p should not exceed $L_0 + d/2$.

There shall be no undercutting due to machining of the parallel length at the transition radii or elsewhere on the gauge section. This feature may be checked with an optical comparator at reasonable magnification (i.e. approximately 10× to 25×) to ensure that there is no undercutting.

Taking into account these requirements, the experience gained by a large number of laboratories and the results of calculations taken from different types of specimens (see References [24], [25], [26], [27],

[28], [29], [30], [31], [32] and [33]), the following geometric dimensions for cylindrical specimens (see Figure 3) are recommended:

- diameter of cylindrical gauge length: $5 \text{ mm} \leq d \leq 10 \text{ mm}$
- parallel length: $4d \geq L_p \geq 2d$
- transition radius (from parallel length to grip end): $r \geq 2d$
- external diameter (grip end): $D \geq 2d$
- length of reduced section: $L_r \leq 8d$

Other geometric cross-sections and gauge lengths may be used for specimens provided that uniform distribution of stress and strain in the gauge length is ensured.

The dimensions of end connections shall be defined as a function of the test machine. Recommended end connections are as follows:

- smooth cylindrical connection (with hydraulic jaws);
- button-end connection.

The test fixture shall locate the specimen and provide axial alignment. It shall not permit backlash. Design of the test fixture will depend on the specimen end details. A number of examples are shown in Figure 4.

Designs of fatigue specimens in which alignment may depend on screw threads are not recommended and should be avoided.

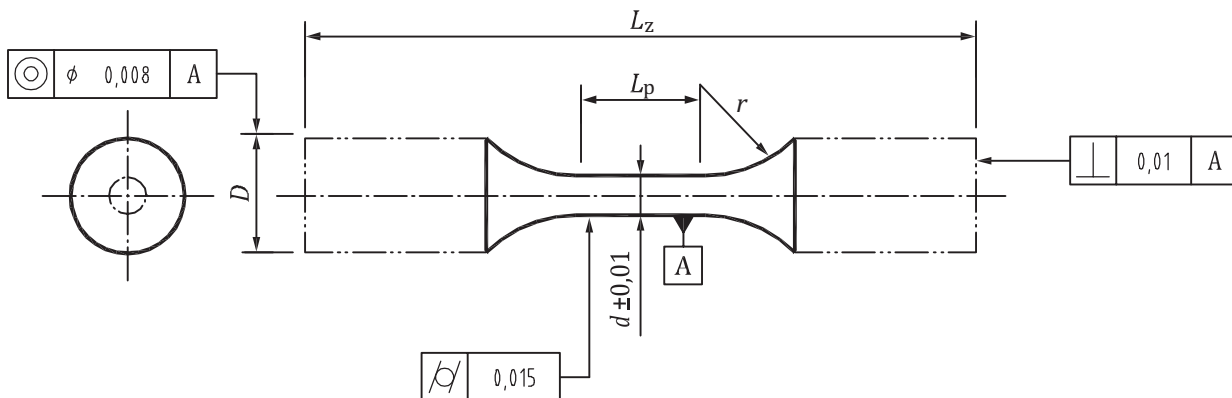

NOTE All dimensions in millimetres.

Figure 3 — Recommended geometry of cylindrical specimen

6.1.2 Flat sheet products

6.1.2.1 General

In general, the considerations discussed in the preceding paragraphs also apply to tests on flat sheet products. However, these tests may require specific geometries and special fixtures in order to avoid problems of bifurcation buckling.

Because low forces are generally applied, more sensitive force transducers may be required. The gripping system may necessitate the use of flat mechanical or hydraulic jaws. However, with the latter type of assembly, it is difficult to ensure correct axial alignment.

In general, the width of the specimen is reduced in the gauge length to avoid failures at the specimen/grip interface or within the grips. In some applications, it may be necessary to add end tabs to increase the grip end thickness, as well as to avoid failure in the grips (see [Figure 5](#)).

The correct alignment of the specimen shall be carefully checked with a trial specimen for:

- parallelism and alignment of the grips;
- alignment of specimen with the loading axis.

This verification shall be carried out using a specimen, with geometry as similar as possible to that of the test specimen, instrumented with strain gauges on the two faces.

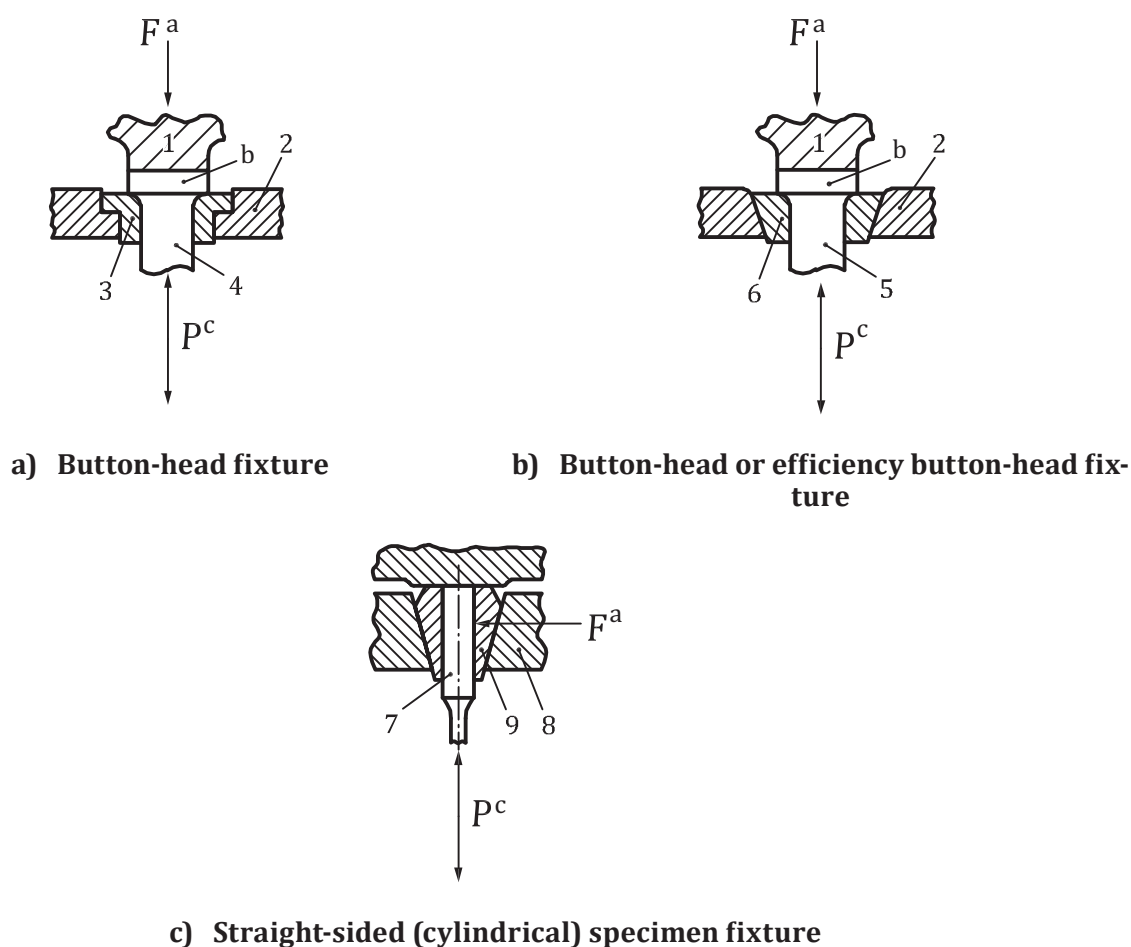

Key

- | | | | |
|---|--|---|----------------------|
| 1 | clamp | 6 | conical split collar |
| 2 | body of fixture | 7 | cylindrical specimen |
| 3 | cylindrical split collar | 8 | body of fixture |
| 4 | button-head specimen | 9 | conical chuck |
| 5 | button-head or efficiency button-head specimen | | |

The clamping force shall be greater than the cyclic load to avoid backlash within the specimen.

- a Clamping force.
- b Flat anvil for specimen alignment.
- c Cyclic load.

Figure 4 — Schematic examples of fixing techniques for various specimen designs

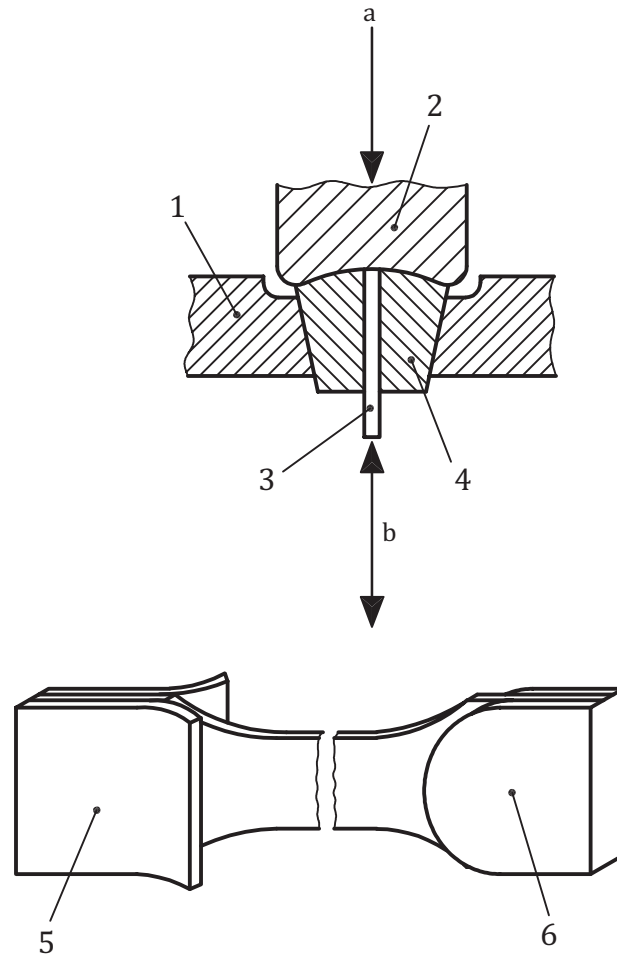

Key

- 1 body of fixture
- 2 conical clamp
- 3 sheet specimen
- 4 conical chuck
- 5 bent end tabs to prevent grip indentation in gripping area (may be held in place by epoxy)
- 6 rounded end tabs
- a Clamping force.
- b Cyclic load.

Figure 5 — Gripping scheme for flat-sheet specimen

It is possible to conduct tests of flat specimens with thicknesses between 2,5 mm and 5 mm without anti-buckling restraints since they are reasonably thick and should resist the propensity for bifurcation buckling.

A possible geometry for a flat specimen is shown in [Figure 6](#). In this case, it is preferable to use an extensometer positioned on one face of the specimen rather than on the edge since there is instability of the attachment on such a thin face.

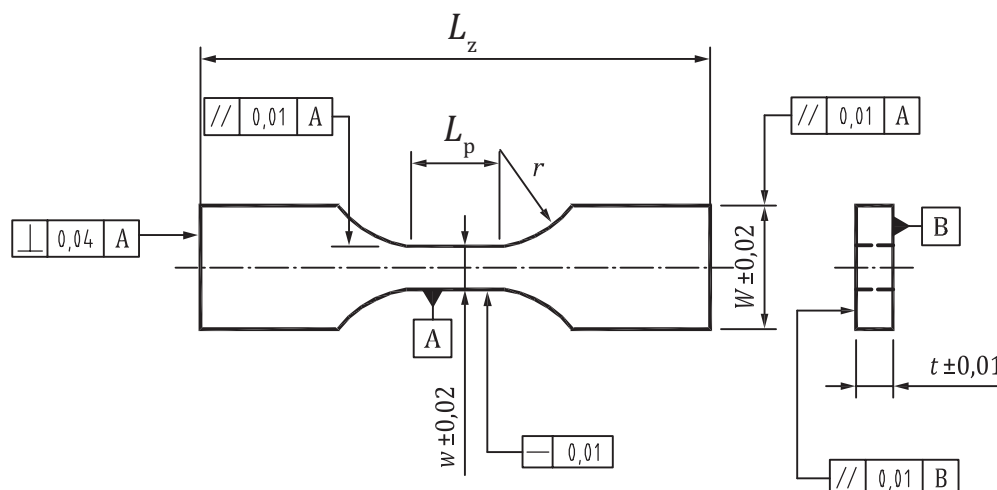

NOTE All dimensions in millimetres.

Figure 6 — Possible geometry of flat-sheet specimen

The use of anti-buckling restraints may be necessary for flat specimens with thicknesses less than 2,5 mm and this may limit the maximum test temperature. The restraint geometries should be matched to those of the specimens and shall allow strains to be measured.

A number of precautions are required to limit the increase in force induced by friction between the restraint and specimen. This friction shall not, at any time, create a force increase greater than 2 % of the applied force. The use of a polytetrafluoroethylene (PTFE) film approximately 1 mm thick, for example, offers a partial solution to this problem, as does boron nitride powder as a dry lubricant. Hydrocarbon-based lubricants are not recommended since they may affect the test results.

The frictional forces may vary from one specimen to another. They shall be measured before each test from the force-displacement curves recorded in the elasticity range of the material in tension with and without anti-buckling restraints. It may be advisable to use two identical extensometers positioned on both sides of the specimen and use the average signal to control the test. This is wise not only in this instance but for axial strain-controlled fatigue testing, in general, should greater strain measurement accuracy be desired. An example of an anti-buckling restraint is shown in [Figure 7](#).

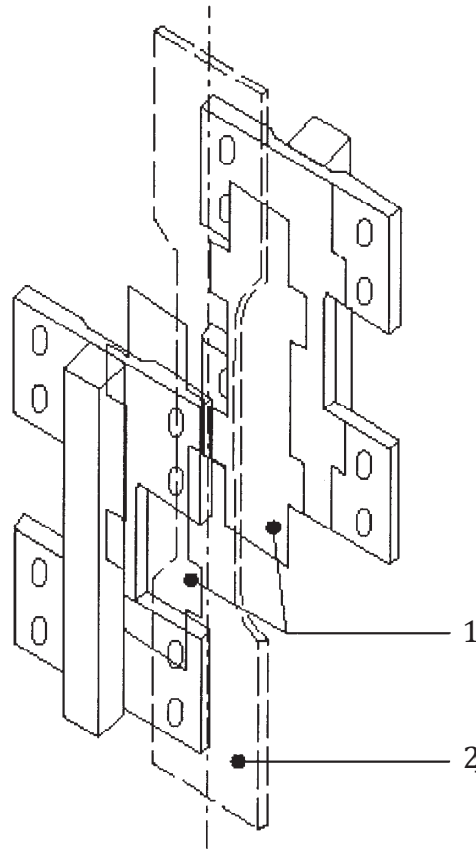

Key

- 1 polytetrafluoroethylene (PTFE) film
- 2 specimen

Figure 7 — Anti-buckling restraints for flat-sheet specimen

6.2 Preparation of specimens

6.2.1 General

In any low-cycle fatigue or a creep-fatigue test programme designed to characterize the intrinsic properties of a material, it is important to observe the following recommendations in the preparation of specimens. A deviation from these recommendations is possible if the test programme aims to determine the influence of a specific factor (surface treatment, oxidation, etc.) that is incompatible with these recommendations. In all cases, any deviation shall be noted in the test report.

6.2.2 Machining procedure

If the test material requires heat treatment it should be conducted prior to machining the test specimens. The machining procedure selected may produce residual stresses on the specimen surface likely to affect the test results. These stresses may be induced by heat gradients at the machining stage or they may be associated with deformation of the material or microstructural alterations. Their influence is less marked in tests at elevated temperatures because they are partially or totally relaxed once the temperature is maintained. However, using an appropriate final machining procedure, especially prior to a final polishing stage, should reduce such residual stresses. For harder materials, surface grinding rather than tool operation (turning or milling) may be preferred.

- Grinding: from 0,1 mm of the final diameter for round specimens or thickness of flat specimens at a rate of no greater than 0,005 mm/pass.

- Polishing: remove the final 0,025 mm with abrasives of decreasing grit size. It is recommended that the final direction of polishing be along the specimen axis.

NOTE 1 Alteration in the microstructure of the material.

This phenomenon may be caused by the increase in temperature and by the strain-hardening induced by machining. It may be a matter of a change in metallurgical phase or more frequently, of surface recrystallization.

The immediate effect of this is to render the test invalid as the material tested is no longer the initial material. Every precaution should therefore be taken to avoid this risk.

NOTE 2 Introduction of contaminants.

The mechanical properties of certain materials deteriorate in the presence of certain elements or compounds. Examples of this are the effect of chlorine and hydrogen on steels and titanium alloys. These elements should therefore be avoided in the products used (cutting fluids, cleaning fluids, such as alcohols, acidic compounds, etc.). Rinsing and degreasing of the specimens in appropriate fluids prior to storage is recommended.

It is highly recommended that traceability of the machining processes be employed and subsequently logged in the test report. It is also prudent to indicate the location, orientation, and position of each specimen should a starting form other than a bar or rod be used as the test program material. For example, a forging, casting or an additive manufactured product where such variables as indicated above would influence fatigue response. ISO 377 specifies requirements for the identification, location and preparation of specimens and test pieces intended for mechanical tests on steel sections, bars, rod, flat products and tubular products as defined in ISO 6929. Further, ISO 3785 designates the test specimen axes in relation to product features.

6.2.3 Sampling and marking

The sampling of test materials from a semi-finished product or a component may have a major influence on the interpretation of the results obtained during the test. It is therefore necessary for this sampling to be carried out with full knowledge of the situation.

A sampling drawing, attached to the test report, shall indicate clearly

- the position of each of the specimens,
- the characteristic directions in which the semi-finished product has been worked (direction of rolling, extrusion, etc., as appropriate), and
- the marking of each of the specimens.

The specimens shall carry a mark at each stage of their preparation. This may be applied using any reliable method in an area not likely to disappear during machining or likely to adversely affect the quality of the test.

6.2.4 Surface condition of specimen

The surface condition of specimens has an effect on the test results. This effect is generally associated with one or more of the following factors:

- specimen surface roughness;
- presence of residual stresses;
- alteration in the microstructure of the material;
- introduction of contaminants.

The recommendations below allow the influence of these factors to be reduced to a minimum.

The surface condition is commonly quantified by the mean roughness or equivalent (e.g. 10-point roughness or maximum height of irregularities). The importance of this variable on the results obtained

depends largely on the test conditions, and its influence is reduced by surface corrosion of the specimen or plastic deformation.

It is preferable, whatever the test conditions, to specify a mean surface roughness R_z of less than $0,2 \mu\text{m}$ (or equivalent).

Another important parameter not covered by mean roughness is the presence of localized machining scratches. Finishing operations on round specimens will normally eliminate all circumferential scratches produced during turning. Final grinding followed by longitudinal mechanical polishing is particularly recommended. A low-magnification check (at approximately $\times 20$) shall not show any circumferential scratches.

If heat treatment is to be carried out after rough finishing of the specimens, it is preferable to carry out the final polishing after the heat treatment. If this is not possible, the heat treatment should be carried out in a vacuum or in inert gas to prevent oxidation of the specimen. Stress relief is recommended in this case.

This treatment shall not alter the microstructural characteristics of the material under study. The specifics of the heat treatment and machining procedure shall be reported with the test results.

6.2.5 Dimensional check

The dimensions shall be measured on completion of the final machining stage using a method that does not alter the surface condition.

6.2.6 Storage and handling

After preparation, the specimens shall be stored so as to prevent any risk of damage (scratching by contact, oxidation, etc.). The use of individual boxes or tubes with end caps is recommended. In certain cases, storage in a vacuum or in a desiccator filled with silica gel is necessary.

Handling shall be reduced to the minimum necessary.

Particular attention shall be given to marking the specimens. It is desirable for both ends of the specimens to be marked so that, after the failure of a specimen, each half may still be identified.

7 Procedure

7.1 Laboratory environment

The low-cycle and creep-fatigue fatigue test are reasonably complex and the quality of the results obtained depends on the methods employed, as well as on the environment.

The tests shall be carried out under suitable environmental conditions:

- uniform ambient temperature and relative humidity;
- minimum atmospheric pollution (dust, chemical vapours, etc.);
- no extraneous electrical signals that will affect machine control and data acquisition;
- minimum extraneous mechanical vibrations.

NOTE It is important to observe and to record the relative humidity when testing certain materials, e.g. aluminium alloys, for which humidity has a significant influence on fatigue life. [34]

7.2 Test machine control

The stability of the servo-control shall be such that the indicated peak values of the applied strain are maintained throughout the test to within $\pm 0,5 \%$ of range of the desired values.

During strain control testing in the long-life fatigue regime (i.e. where nominal cyclic plasticity is negligible at lives of, for example, approximately 10^6 to 10^7 cycles), it is permitted to transfer test modes and conduct a force-controlled fatigue test at a greater frequency in the effort of condensing test time. A fatigue test that is begun in strain control may achieve a stabilized stress-strain response in which case cyclic plasticity is negligibly small. In such a case, the test control mode can be switched to force control and the test frequency increased being cautious not to increase the temperature on the specimen due to hysteretic effects. During such a test mode transfer, the strain should be monitored and adjustments made in the force control mode to maintain the proper strain limits within $\pm 0,5\%$ of the range between maximum and minimum strains. In such a transfer of test modes, ISO 1099 should be consulted for appropriate information.

In a creep-fatigue test where constant stress (force) dwells are included within the cycle, the indicated peak values of the applied force shall be maintained to within $\pm 1\%$ of the desired values.

7.3 Mounting of the specimen

Place the specimen in the grips in such a way that any preliminary strain during mounting is avoided. For a previously aligned system, it is recommended, while in position control, to clamp the specimen to one grip and then move the actuator so the specimen just contacts the second grip. Then maintain a small compressive preload (force control) while the specimen is clamped to the second grip. Next, apply the extensometer, when after zeroing its output a transfer to strain control can be made. The application of anti-seize compounds or the pre-oxidizing of specimen ends may facilitate subsequent specimen removal particularly in higher temperature testing. With the force at zero, it may be necessary to re-zero the extensometer. Commercial extensometers often have pre-set gauge lengths and a means of mechanically re-zeroing them to a fixed gauge. If necessary, resetting the gauge length with such a mechanical device or carefully repositioning the gauge length using one's fingers as near to zero as possible is suggested (i.e. within approximately $\pm 0,5\%$ of test range). Once a "rough" zero position is obtained, electronically re-zeroing the extensometer is suggested. It is also prudent to wear protective gloves, such as cotton or acrylic, when handling specimens prone to possible corrosive attack.

7.4 Cycle shape — Strain rate or frequency of cycling

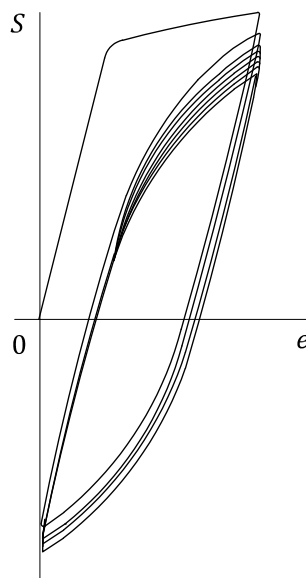

Figure 8 — Stress-strain hysteresis loops for 0-max strain testing, $R_e = 0$

Performing strain-controlled testing at R -ratios other than $R_e = -1$ is often done to ascertain trends in material behaviour. Figure 8 illustrates a sequence of stress-strain hysteresis loops during testing at, in this case, $R_e = 0$. As shown for this tension-biased mean strain, there is a cyclic relaxation of the mean stress tending toward a zero mean stress value. In such cases, it is recommended that careful monitoring

and recording of such stress-strain and mean stress information be performed for subsequent data analysis and determination of material trends. For $R_e = \infty$, the hysteresis loops will demonstrate similar behaviour but in the opposite stress sense where stress relaxation will tend toward a less negative value as the hysteresis loop travels in an upward direction in stress-strain space.

NOTE Performing tests at $R_e = 0,1$ does not always prevent bifurcation buckling since cyclic mean stress relaxation during testing may result in the lower part of the hysteresis loop being in compression as indicated by the stress-strain response in [Figure 8](#).

The same cycle shape for the controlled parameter (i.e. strain) shall be retained throughout the whole test programme unless the aim of the test programme is to study the effect of the cycle shape on the behaviour of the material. Tests are generally conducted at constant total strain rate, within the range $5 \times 10^{-4} \text{ s}^{-1}$ to $5 \times 10^{-2} \text{ s}^{-1}$ (0,05 % s^{-1} to 5 % s^{-1}), implying a triangular cycle shape. Sinusoidal cycling, typically within the range 0,01 Hz to 1 Hz, is permitted at ambient temperature but not recommended at high temperatures because it results in variable strain rates.

Creep-fatigue cycles are normally constructed from constant total strain rate ramps that may well be different in the tension going and compression going directions, together with stress and/or strain dwells ranging from a few minutes to tens or even hundreds of hours. This is explained further in [Clause 8](#).

7.5 Start of test

7.5.1 Preliminary measurements

It is recommended that testing begin by cycling within the elastic range of the material at ambient temperature in order to measure the modulus of elasticity of the material and ensure the correct functioning of the measuring system (force and strain). The value of this modulus should not deviate by more than $\pm 5 \%$ from the expected value.

In the same context (verification of the strain and temperature measuring chain), it is recommended where possible that the coefficient of mean expansion of the material be determined by monitoring the thermal strain recorded by the extensometer as the temperature changes from ambient temperature to test temperature (machine under load control and zero force). This coefficient should not deviate by more than $\pm 5 \%$ from the expected value.

Usually, the extensometer is mounted on the specimen at ambient temperature and will not be readjusted to the original gauge length after transition to the test temperature. In this case, the strain measurement at elevated temperature shall correct for the gauge length extension due to thermal expansion. Therefore, the gauge length extension shall at least be recorded for post-test correction. Automated systems shall use the corrected gauge length for online control and data acquisition.

In some systems, especially at temperatures $>1\ 000 \text{ }^\circ\text{C}$, the extensometer may be mounted while the specimen is "hot". In this case, it will not be possible to determine the linear expansion coefficient.

If fatigue testing is conducted at an elevated temperature, it is recommended to

- a) pre-compress the specimen at room temperature by an amount equal to the product of the coefficient of linear expansion of the metal and the difference between room temperature and the test temperature (i.e. $\alpha\Delta T$),
- b) establish the gauge length at the test temperature, and
- c) zero the extensometer and compensate within the test program to the newly established gauge length at the test temperature.

7.5.2 Test commencement

For a specific test programme, it is necessary to select the direction of the first quarter of the cycle. It is usual to select tension-going. However, in actual, thermally induced, low-cycle fatigue situations, the first quarter-cycle is usually compression-going.

For tests carried out under strain control, it will normally be required to change to strain from force control following modulus checks and specimen heat-up. The test machine controls shall accomplish this transfer without “overshoots” (i.e. additional strains beyond the desired controlled strain value) that may prejudice the rest of the test.

The amplitude of the strain limits shall not exceed that selected as the test control parameter by more than 5 %. Adjustment of the strain, in order to attain the desired strain level under the requirements specified in [7.2](#), shall be completed within 10 cycles or 1 % of the number of cycles to failure, whichever is less.

In the event of an inadvertent or accidental stop, before restarting, ensure that

- the specimen has not been damaged by the stop, i.e. bent,
- the extensometer has not slipped,
- there is continuity in stress as it was prior to the accidental stop,
- the modulus is the same as prior to the accidental stop, and
- the strain limits are the same as prior to the accidental stop.

The occurrence of these events may be verified by analysing the recordings. In these conditions, a restart without overshoot is permissible.

7.6 Number of specimens

A minimum of eight specimens is recommended to generate a fatigue strain-life curve covering at least three decades in numbers of cycles.

7.7 Data recording

7.7.1 Stress-strain hysteresis loops

At the start of the test, a continuous recording shall be made of the initial hysteresis loops — stress response as a function of the controlled strain. Then, during the course of the test, a periodic recording is sufficient. The frequency of these recordings shall be chosen as a function of the intended overall duration of the test. The option generally used consists of recording the first 10 cycles and then applying a logarithmic increase (20, 50, 100, 200, 500, etc.) at the rate of three hysteresis loops per decade.

In the case of automated data acquisition, the recording of loops may be programmed either with a predefined interval or as a function of the progression of each of the two parameters (stress and strain). In all cases, the sampling frequency shall be sufficient to allow clear definition of the hysteresis loop (see [5.4.1](#)).

7.7.2 Data acquisition

If test equipment permits, record stress, strain and temperature as functions of time, as well as hold or dwell times in a creep-fatigue test as explained in [Clause 8](#). If this is not possible, at least record peak values of stress, strain and temperature so that the definition of failure given in [7.8](#) may be invoked.

7.8 End of test

The test is terminated when the conditions for the selected end-of-test criterion are fulfilled where the test machine is equipped with facilities allowing this criterion to be applied. If this is not the case, there shall be other possibilities for stopping the machine, either when a force threshold value is no longer reached (generally, a small fraction of full-scale stress response depending on the range) or, using the control signal, when the deviation between the command signal and feedback signal reaches a certain error value.

It is desirable that a test should not be automatically terminated by inappropriate, pre-selection of stress limits, for example, in the case of continuous cyclic softening or cyclic relaxation of mean stress as illustrated in [Figure 8](#). It is recommended in such cases that material response be observed prior to selection of stress limits and, in fact, a *post facto* determination of the number of cycles to failure may be necessary.

If the test terminates automatically prior to end of test criterion of the specimen, the data shall be reviewed prior to specimen removal to ensure that the criterion has been achieved. If premature termination has occurred, then the test can be restarted (see [7.5.2](#)). If the criterion has been met, then force control shall be re-established and zero force set for cool-down and specimen removal. If end of test criterion is “complete separation”, then the normal procedure would be to switch to “position control” for cool-down and specimen removal.

For high-temperature tests, the furnace shall be switched off as soon as the test terminates in order to limit the oxidation of the specimen and cracked surfaces with a view to conduct subsequent fractographic examinations. If a test terminates prior to end of test criterion, every effort shall be made to ensure that the specimen will not be over-forced during cool-down of the heating device.

NOTE This latter statement is particularly true for electro-mechanical machines.

7.9 Failure criteria

There are various ways of defining the end of test. It may depend on the interpretation of the fatigue test result and on the nature of the material being tested. The end of test criteria under consideration are generally based on the appearance, presence or intensification of a phenomenon that has been observed or recorded that indicates severe damage or imminent failure of the specimen.

The number of cycles to failure, N_f , may be defined as the number of cycles corresponding to the following end of test criteria:

- a) a certain percentage change in the maximum tensile stress in relation to the level determined during the test;
- b) a certain change in the ratio of the moduli of elasticity in the tensile and compressive part of the hysteresis loops; typically, $E_T / E_C = 0,9$ is employed for defining failure (see [Figure 9](#));
- c) the (obvious) fracture of the specimen.

NOTE 1 Post-test examination will benefit from termination of the test while employing the definitions given above.

It is recommended that the crack initiation site be recorded in relationship to the test machine frame, i.e. the quadrant in which the specimen is cracked. This feature will aid subsequently in determination of possible test machine or gripping misalignment.

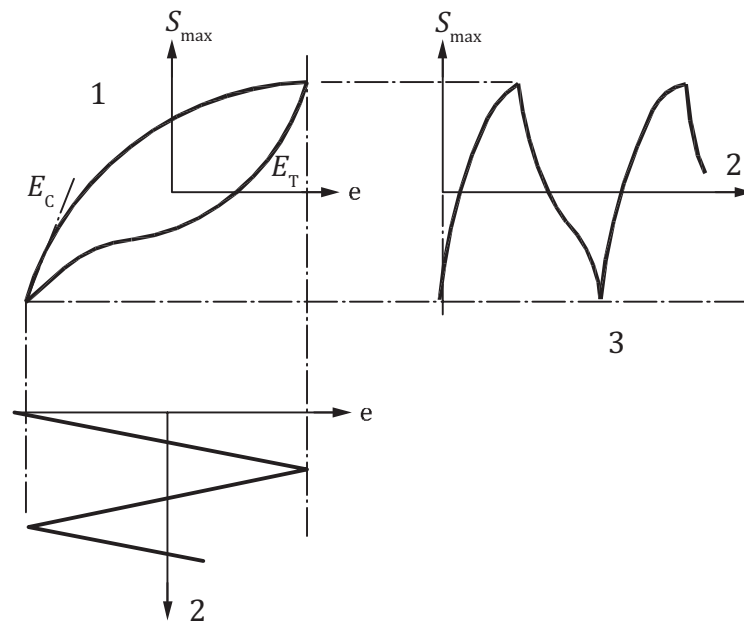

Key

- 1 stress-strain hysteresis loop
- 2 time
- 3 stress-time response in strain control

Figure 9 — Definitions of tension and compression modulus for determination of failure

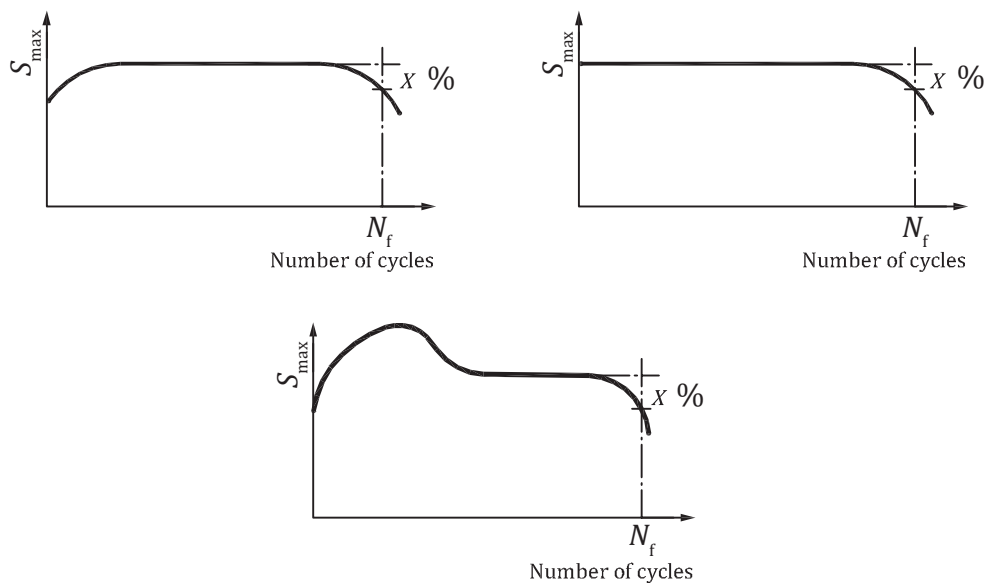

a) For materials with stable or steady-state behaviour after initial hardening then softening

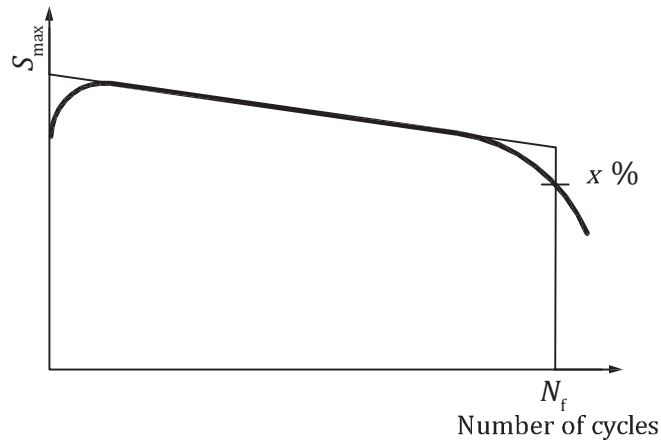

b) For materials with continuous softening

Figure 10 — Failure criterion based on stress (log-log coordinates)

The specific end of test criteria used for the test series shall be reported. [Figure 10](#) shows examples of the stress-decrease criterion. In this case, the number of cycles to failure, N_f , is defined as the number of cycles corresponding to a decrease of $x\%$ in the stress value extrapolated over the tensile stress-number of cycles curve when the stress falls sharply. A common value of x is 10. However, a typical range for x -values is 2 % to 30 %.

The number of cycles to failure is commonly evaluated from the upper stress or force or from the range of stress or force. In the case of a fracture outside of the extensometer, an increase of the upper/maximum tensile stress of $x\%$ should be used.

This criterion relates to the presence of one (or more) macroscopic crack(s) in the specimen. In general, the ratio of cracked surface area to the original cross-sectional area of the specimen is of the same magnitude as the ratio of stress decrease.

For totally fractured or partially fractured specimens respectively, the location of the fracture surface or of the crack in relation to the gauge length shall be identified and shall appear in the test results.

A post-test examination of the specimen shall be conducted in order to ensure the validity of the test. This means checking on the one hand for the correct location of the failure or main cracks and, on the other, ensuring the absence of faults or anomalies that could lead to incipient and premature failure (surface faults, porosity, inclusions, excessively large imprints left by the extensometer or bending of the specimen related to an alignment problem).

8 High-temperature strain-controlled creep-fatigue testing

This document also provides a methodology for strain controlled, creep-fatigue testing when dwell periods at constant stress and/or constant strain are incorporated within the cycle that is performed at uniform temperature.

In many real structural components, creep, as well as low-cycle, fatigue are typically the result of service conditions involving thermal cycles that include hold (or dwell) periods where the components are at some constant state of stress or strain during which creep or monotonic stress relaxation may occur. The combination of mechanical cycling with dwell periods is referred to as creep-fatigue. Several such examples are illustrated in [Figure 11](#) for a typical low-cycle fatigue and three creep-fatigue cycles.

A further level of service simulation involves cycling both the mechanical forces and the temperature together with dwells as appropriate. This combination is known as thermal-mechanical fatigue (TMF) and is the subject of a separate ISO 12111.

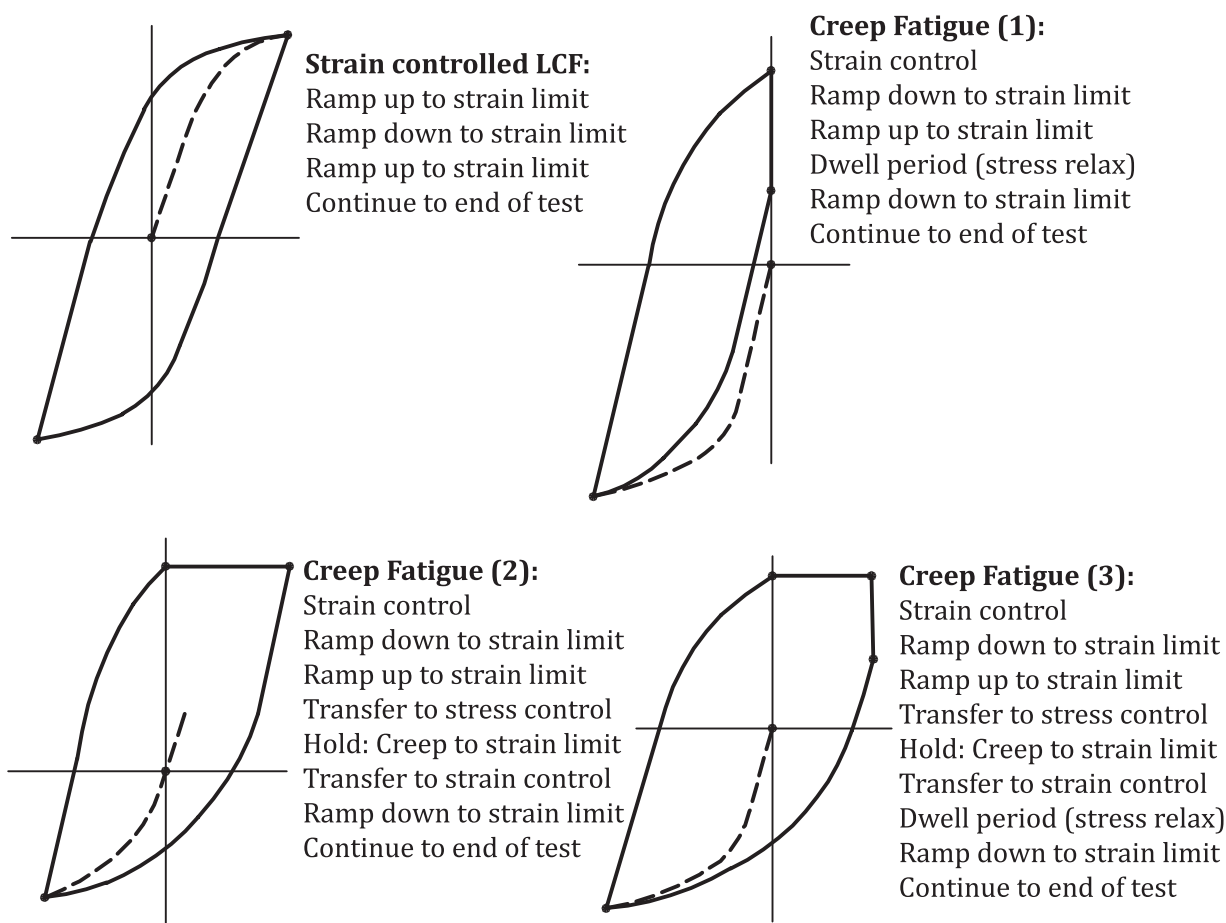

NOTE All hysteresis loops held within overall strain limits to prevent strain ratcheting.

Figure 11 — Examples of hysteresis loops for low-cycle fatigue and creep-fatigue cycles

9 Expression of results

9.1 Basic data (recorded data (see 7.7))

Peak stress and strain range values as a function of the number of cycles, stress-strain hysteresis loops at a specified recording frequency according to 7.7.1 and the number of cycles corresponding to the first of the two following events to occur shall be recorded:

- total separation;
- drop of the tensile stress below the value selected in 7.8.

9.2 Analysis of low-cycle fatigue results at $R_e = -1$

9.2.1 Distinction between different types of strain values

The different types of strain value are as follows:

Values of e_{\max} and e_{\min} imposed during the test are measured and Δe_t is the strain range (see 3.10);

Δe_e is calculated from $\frac{\Delta S}{E}$.

Δe_p is obtained by measuring the hysteresis loop width at mean stress, $\Delta e_e = \Delta e_t - \Delta e_p$.

9.2.2 Determination of fatigue life (see 7.9)

The number of cycles to failure N_f is defined in 7.9, a) to c).

9.2.3 Stress-strain and strain-fatigue life relationships

Tables 5 to 7 show the properties determined in a monotonic tensile test (reference material data) and in a low-cycle fatigue test [monotonic stress-strain curve (first quarter of cycle), cyclic stress-strain curve at approximately $N_f/2$, and fatigue life N_f].

Table 5 — Monotonic test — Monotonic stress-strain values

Property	Determination	Relation
E	Modulus of elasticity measured for a given specimen (see Table 2)	
n	Monotonic strain hardening exponent	Slope of a $\lg \sigma_a - \lg \Delta \varepsilon_p/2$ plot
K	Monotonic strength coefficient. Stress intercept at $\varepsilon_{pa} = 1$ on $\lg \sigma_a - \lg \Delta \varepsilon_p/2$ plot.	$\sigma_a = K(\Delta \varepsilon_p/2)^n$ plot

Table 6 — Cyclic test at $R_e = -1$ — Cyclic stress-strain values (stabilized hysteresis cycle)

Property	Determination	Relation
σ_y' , cyclic yield strength (0,2 % offset)		
n' , cyclic strain hardening exponent	Slope of $\lg \sigma_a = \lg \Delta \varepsilon_p/2$ plot	
K' , cyclic strength coefficient	Stress intercept at $\varepsilon_{pa} = 1$ on $\lg \sigma_a - \lg \Delta \varepsilon_p/2$ plot	$\sigma_a = K'(\Delta \varepsilon_p/2)^{n'}$
Constitutive formula		$\frac{\Delta \varepsilon_t}{2} = \frac{\sigma_a}{E} + \left(\frac{\sigma_a}{K'} \right)^{1/n'}$

Table 7 — Low-cycle fatigue test from $R_e = -1$ — Fatigue life

Property	Determination	Relation
σ_f' , fatigue ductility coefficient	Stress intercept at $2N_f = 1$ on $\lg \sigma_a - \lg 2N_f$ plot	$\sigma_a = \sigma_f'(2N_f)^b$
b , fatigue strength exponent	Slope of $\lg (\Delta \varepsilon_e/2) - \lg 2N_f$ plot (Specify $2N_f$ range)	(Basquin formula)
ε_f' , fatigue ductility coefficient	Plastic-strain intercept at $2N_f = 1$ on $\lg (\Delta \varepsilon_p/2) - \lg 2N_f$ plot	$\Delta \varepsilon_p/2 = \varepsilon_f'(2N_f)^c$
c , fatigue ductility exponent	Slope of $\lg (\Delta \varepsilon_p/2) - \lg 2N_f$ plot (Specify $2N_f$ range)	(Coffin-Manson formula)
Total strain amplitude	$\Delta \varepsilon_t/2 = \Delta \varepsilon_e/2 + \Delta \varepsilon_p/2$ $\Delta \varepsilon_t/2 = [\sigma_f'/E](2N_f)^b + \varepsilon_f'(2N_f)^c$	

At $R_e = -1$, fatigue results are often used to express the functional cyclic stress-strain relationship and the strain-life relationship of a material. For example, the total strain amplitude is expressed in terms of the elastic strain and the plastic strain components, as given in [Formula \(1\)](#):

$$\frac{\Delta\varepsilon_t}{2} = \frac{\Delta\varepsilon_e + \Delta\varepsilon_p}{2} = \frac{\Delta\sigma}{2E} + \frac{\Delta\varepsilon_p}{2} \quad (1)$$

and recognizing that the cyclic stress-strain relationship, as given in [Formula \(2\)](#):

$$\frac{\Delta\sigma}{2} = K' \left[\frac{\Delta\varepsilon_p}{2} \right]^{n'} \quad (2)$$

that, upon substitution, becomes as given in [Formula \(3\)](#):

$$\frac{\Delta\varepsilon_t}{2} = \frac{\Delta\sigma}{2E} + \left[\frac{\Delta\sigma}{2K'} \right]^{\frac{1}{n'}} \quad (3)$$

For the plastic strain, log-log linear portion of the total strain-life relationship, we may write the Coffin-Manson relationship, as given in [Formula \(4\)](#):

$$\frac{\Delta\varepsilon_p}{2} = \varepsilon_{f'} [2N_f]^c \quad (4)$$

and for the Basquin or elastic strain life log-log linear portion of the total strain, we can write as given in [Formula \(5\)](#):

$$\frac{\Delta\sigma}{2} = \sigma_{f'} [2N_f]^b \quad (5)$$

that upon combining these log-log linear relationships becomes as given in [Formula \(6\)](#):

$$\frac{\Delta\varepsilon_t}{2} = \left[\frac{\sigma_{f'}}{E} \right] (2N_f)^b + \varepsilon_{f'} (2N_f)^c \quad (6)$$

or the familiar strain-life relationship.

In the above constitutive relationships, it is to be noted that the designations for the strain and stress are that of true stress and true strain and that these are essentially equal to the engineering stress and engineering strain to total strain values of approximately 10 %. It should also be noted that the terminology for plastic strain and inelastic strain are used interchangeably.

9.3 Analysis of creep-fatigue results

Analysis of creep-fatigue data are not discussed in detail within this testing standard since there exists no commonly accepted methodology. In general, methods used for analysis reflect the specific needs of new materials development, production materials performance confirmation and/or component simulation.

10 Test report

10.1 General

The test report shall include full information on the aim of the study and the material. It shall also include the details of the test methods and conditions, the analysis and presentation of the results and descriptions of any anomalies or interruptions that may have arisen during each test.

This information is indicated in [10.2](#) to [10.8](#).

10.2 Purpose of the test

State the aim of the study.

10.3 Material

- Standardized designation;
- composition in mass percent;
- product;
- heat treatment;
- microstructure/hardness;
- mechanical properties at test temperature.

10.4 Specimen

Provide a drawing of the specimen indicating:

- the direction and location of sampling from the product;
- the final machining phase and mean longitudinal roughness value R_a .

10.5 Test methods

- Test machine:
 - frame capacity: \pm kN, calibration: kN (10 V, X-bit resolution);
 - type of actuator (hydraulic, electro-mechanical, etc.);
 - force capacity of actuator: \pm kN;
 - controller type (analog, digital, hybrid).

NOTE A hybrid controller has an analog servo-loop plus a digital operator interface.

- Load train:
 - type of grip (manually or hydraulically preloaded + description or photo);
 - method of ensuring axially and level of bending at typical test force(s).
- Heating system:
 - type of furnace (resistive, radiant, inductive, etc.);
 - estimate of axial temperature gradient in gauge length of specimen: °C;
 - temperature and variation in temperature during test: °C \pm °C;
 - type of thermocouple;

- heat-up time, time at test temperature prior to test commencing, and time at test temperature during test.
- Extensometer:
 - description of extensometer used (diagram or photo);
 - gauge length: mm;
 - operating range: \pm mm (10 V, X-bit resolution);
 - calibration procedure and results;
 - date of last calibration:

10.6 Test conditions

- Axial-strain range:
- strain ratio $R_e (= e_{\min}/e_{\max})$:
- waveform:
- strain rate or frequency:
- first quarter-cycle (tensile or compressive);
- details of dwell period(s) and the control strategy adopted.

10.7 Presentation of results

10.7.1 Presentation of single test results

For each test, prepare

- a table giving the total engineering strain values (max., min., range), engineering stress (max., min., range) and plastic-strain variation as a function of number of cycles in accordance with [Table 8](#),
- two curves giving the variation in the maximum and minimum engineering stresses as a function of the number of cycles in log-linear coordinates and in linear coordinates, and
- hysteresis loops representative of test start-up and near mid-life, and those representative of failure.

NOTE Log-linear coordinates are normally preferred.

Table 8 — Variation in engineering strain and engineering stress as a function of number of cycles during a low-cycle fatigue test

Material:

Specimen reference:

Total engineering strain applied:

Test temperature:

Modulus of elasticity, E :

Engineering strain rate:

Cycle	Total engineering strain %			Engineering stress MPa			Engineering plastic strain %
	max.	min.	range	max.	min.	range	range

10.7.2 Presentation of results of test series

For a series of tests, prepare:

- a table, [Table 9](#), summarizing the results in order of decreasing strain amplitudes,
- the curves representing the variation in:
 - the total engineering strain amplitude e_{ta} as a function of the number of cycles (log-log coordinates),
 - the engineering stress amplitude S_a at mid fatigue life as a function of the number of cycles (log-log coordinates),
 - the engineering stress amplitudes S_a as a function of total engineering strain amplitude e_{ta} (log-log coordinates), indicating the values for K, n, K' and n' ,

- the engineering total-, elastic- and plastic-strain amplitudes as a function of the number of cycles (log-log coordinates), indicating the values of the coefficients S_f' , b , e_f' and c .

For parametric relationships, the number of tests for which the coefficients have been determined shall be stated in addition to the domain of the fit.

Examples of graphical representations are shown in [Figures B.1](#) to [B.4](#).^{[13][18]}

Table 9 — Summary of results of a test series

Strain amplitude	Number of cycles to failure	Stress amplitude at mid-life
e_{10}	$N_{f,10}$	S_{10}
e_9	$N_{f,9}$	S_9
e_8	$N_{f,8}$	S_8
e_7	$N_{f,7}$	S_7
e_6	$N_{f,6}$	S_6
e_5	$N_{f,5}$	S_5
e_4	$N_{f,4}$	S_4
e_3	$N_{f,3}$	S_3
e_2	$N_{f,2}$	S_2
e_1	$N_{f,1}$	S_1

10.8 Values to be stored in a low-cycle fatigue database

It is good practice to store data essential for the use of results of low-cycle fatigue tests in an easily accessible and user-friendly form.

These data include but are not limited to:

- the table summarizing individual test results ([Table 8](#));
- the table summarizing the test results for the series ([Table 9](#));
- a table summarizing the analysis of the results in accordance with [Table 10](#).

[Tables 8](#), [9](#) and [10](#), prepared using a computer and spread sheet-type software, may serve as a basis for preparing a database that is exportable by means of a communication network or disk (data files generally being in ASCII format).

Table 10 — Analysis of low-cycle fatigue test results

<p>Date:</p> <p>Data source:</p> <p>Material (standardized designation)</p> <ul style="list-style-type: none"> — Chemical composition: — Heat treatment: — Special specifications: <p>Test conditions</p> <ul style="list-style-type: none"> — Purpose of test: — Product: — Sampling from product: — Specimen type: — Test temperature: — Test machine(s): — Control mode: — Waveform: — Frequency or strain rate: — Definition of failure: — Number of specimens and domain of the fit: — <u>Axial-strain range</u> <p>Cyclic stress-strain properties (stabilized cycle)</p> <p>σ_y' cyclic yield strength</p> <p>n' cyclic strain hardening exponent</p> <p>K' cyclic strength coefficient</p> <p>Fatigue properties</p> <p>σ_f' fatigue strength coefficient</p> <p>b fatigue strength exponent</p> <p>ϵ_f' fatigue ductility coefficient</p> <p>c fatigue ductility exponent</p>

Annex A (informative)

Measurement uncertainty

A.1 General

A.1.1 Evaluating measurement uncertainty is highly desirable but not a mandatory requirement in the present document.

A.1.2 ISO/IEC 17025[6] requires all calibration and testing laboratories to provide the uncertainty estimates or the procedure for estimating the uncertainty associated with their test results. A customer may also demand requirements for measurement uncertainty information or the testing laboratory itself may want to gain a better understanding of which aspects of the test procedure have the greatest effect on results so that these may be monitored more closely or improved.

A.1.3 Where information is available, it is recommended that the uncertainty is estimated in accordance with the GUM.[10] All the terminology used should be in accordance with GUM[10] and VIM.[11]

A.1.4 Measurement uncertainty is defined[7] as “non-negative parameter characterizing the dispersion of the **quantity values** being attributed to a **measurand**, based on the information used”.

A.1.5 According to the GUM, measurement uncertainty comprises, in general, many components. Some of these may be evaluated by **Type A evaluation of measurement uncertainty** from the statistical distribution of the quantity values from series of **measurements** and can be characterized by standard deviations. All the other components, which may be evaluated by **Type B evaluation of measurement uncertainty**, can also be characterized by standard deviations and evaluated from probability density functions based on other information.

For a given set of information, it should be understood that the measurement uncertainty is associated with a stated quantity value attributed to the measurand. A modification of this quantity value would most likely result in a modification of the associated uncertainty

A.2 Guidelines for evaluation of uncertainty in axial stress (or strain) controlled testing

A.2.1 It is recommended to identify, rank and list all the significant sources that contribute (either directly or indirectly) to the uncertainty of the fatigue life, N_f , result (or results) being reported. It should be noted that the list is uniquely associated with the testing procedure, specimen, apparatus, laboratory environment and possibly operator. This means that the list should be carefully reconsidered each time a source changes

A.2.2 For example, in axial stress-controlled (or strain-controlled) fatigue testing, it is envisaged that significant sources of input uncertainties identified in [A.2.1](#) relating to fatigue life will (**in order of significance**) include

- a) uncertainty due to superimposed bending in the specimen resulting from misalignment between the direction of the applied force and the specimen's axis,
- b) uncertainty in controlling the applied stress (or strain),

- c) uncertainty in the test temperature (in elevated testing), and
- d) uncertainty associated with the chosen definition of failure.

A.2.3 Where information is available, it is recommended that uncertainty is estimated in accordance with a GUM-based protocol. The protocol should include **all** the parameters identified in [A.2.2](#). It should also be agreed before undertaking the work between the testing laboratory and the client. Examples of protocols for estimating measurement uncertainty in fatigue testing can be found in Reference [\[23\]](#).

A.2.4 Evaluating uncertainty may necessitate performing specific measurements and/or additional fatigue tests. It may also involve performing Monte Carlo simulations. Considerations for such requirements should be agreed with the client before undertaking the work.

A.2.5 The reported uncertainty should also include the level of confidence and a statement describing how the calculations were made.

A.2.6 It should be recognized that there will be situations where a reliable uncertainty estimate cannot be obtained due to lack of information needed for the uncertainty calculation

Annex B (informative)

Examples of graphical presentation of results

Material: 316 L
 Temperature: 550 °C
 Specimen: 5E47
 Total strain amplitude: 0,47 %

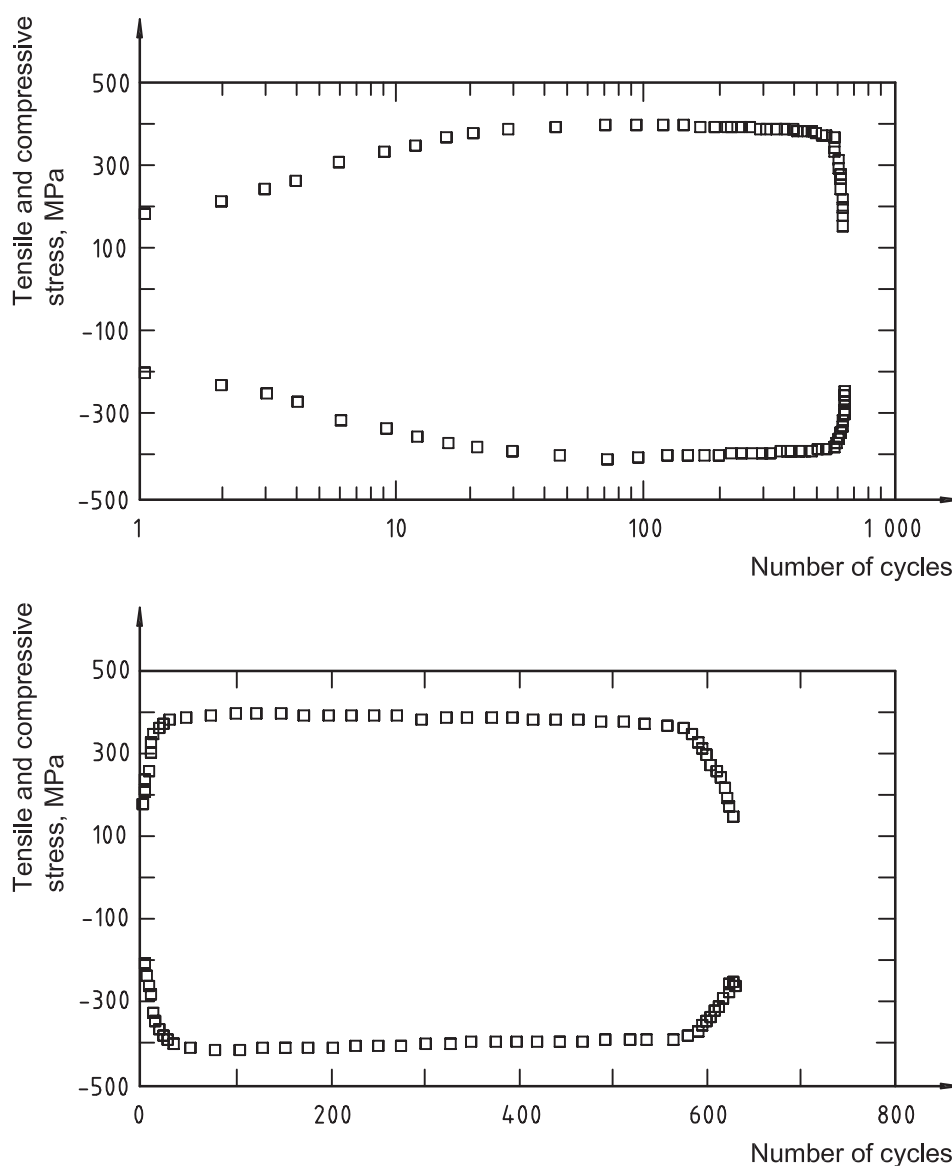

Figure B.1 — Variation of tensile and compressive stresses as a function of the number of cycles (linear-log and linear-linear coordinates)

Material: 316 L

Temperature: 550 °C

Monotonic stress-strain curve: $\sigma_a = K(\Delta\varepsilon_p/2)^n$ ($K = 316; n = 0,1267$)
 $(1,9 \times 10^{-3} < \varepsilon_{pa} < 8,5 \times 10^{-3})$

Cyclic stress-strain curve: $\sigma_a = K'(\Delta\varepsilon_p/2)^{n'}$ ($K' = 241,8; n' = 0,3674$)
 $(1,3 \times 10^{-3} < \varepsilon_{pa} < 7,2 \times 10^{-3})$

Total stress-strain curve:

$$\frac{\Delta\varepsilon_t}{2} = \frac{\sigma_a}{E} + \left(\frac{\sigma_a}{K'} \right)^{1/n'}$$

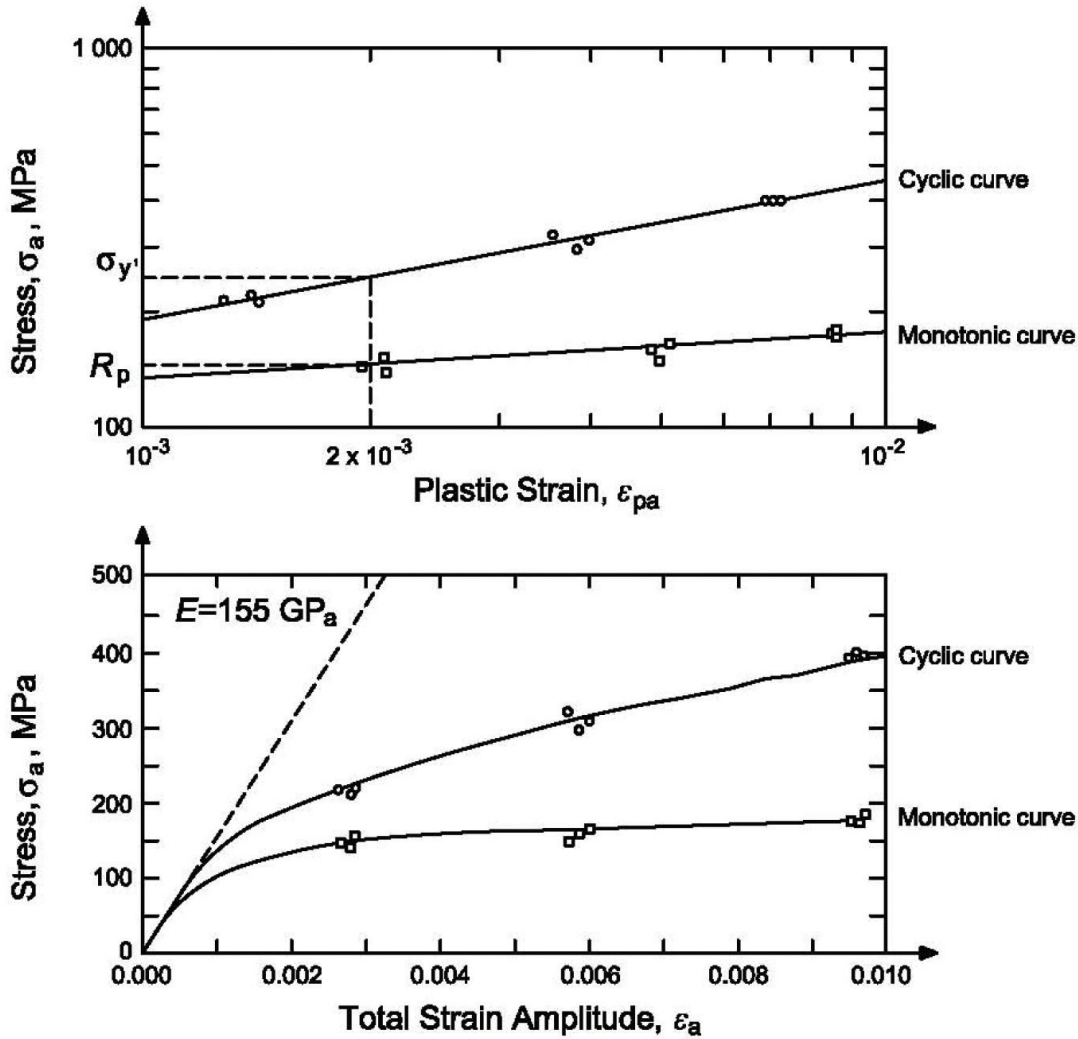

Figure B.2 — Monotonic and cyclic stress-strain curves (upper curves are lg-lg and lower curves are linear coordinates)

Material: 316 L
Temperature: 550 °C

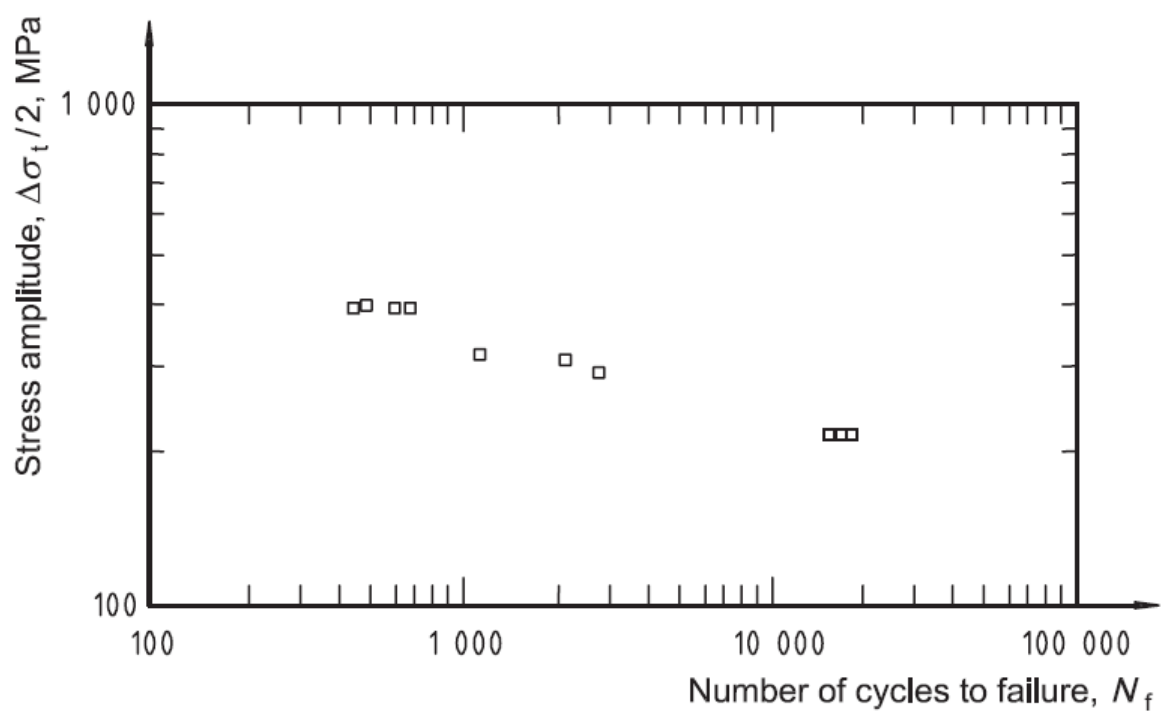
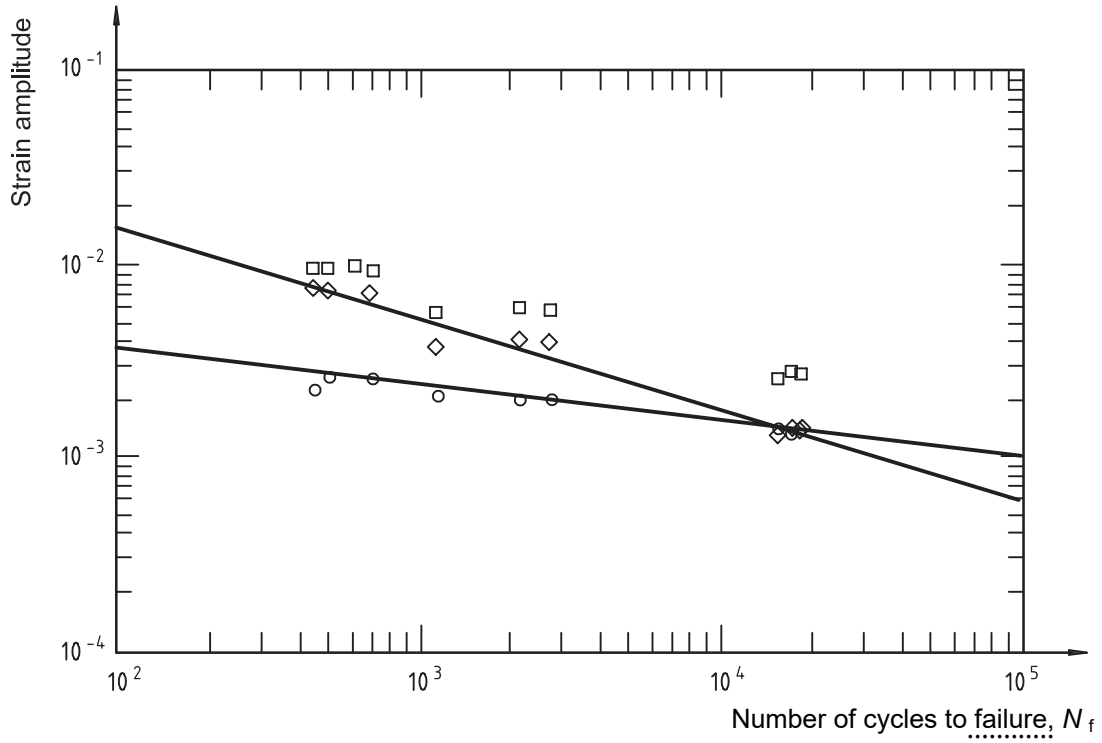

Figure B.3 — Variation of strain amplitude $(\Delta\varepsilon_t)/2$ and stress amplitude $(\Delta\sigma)/2$ at $N_f/2$ as a function of the number of cycles to failure N_f (log-log coordinates)

Material: 316 L

Temperature: 550 °C



Key

- $\Delta\epsilon_t/2$
- ◇ $\Delta\epsilon_p/2$
- $\Delta\epsilon_e/2$

Figure B.4 — Variation of total-, plastic- and elastic-strain amplitude as a function of the number of cycles to failure N_f (log-log coordinates)

Bibliography

General references

- [1] ISO 377, *Steel and steel products — Location and preparation of samples and test pieces for mechanical testing*
- [2] ISO 1099, *Metallic materials — Fatigue testing — Axial force-controlled method*
- [3] ISO 3785, *Metallic materials — Designation of test specimen axes in relation to product texture*
- [4] ISO 4965-1, *Metallic materials — Dynamic force calibration for uniaxial fatigue testing — Part 1: Testing systems*
- [5] ISO 4965-2, *Metallic materials — Dynamic force calibration for uniaxial fatigue testing — Part 2: Dynamic calibration device (DCD) instrumentation*
- [6] ISO/IEC 17025, *General requirements for the competence of testing and calibration laboratories*
- [7] ASTM E 606-12, *Standard Practice for Strain-Controlled Fatigue Testing*
- [8] AFNOR A 03-403:1990, *Metal products — Low-cycle fatigue test [In French]*
- [9] BS 7270:2006, *Method for constant amplitude strain controlled fatigue testing*
- [10] JCGM 102, *Guide to the expression of uncertainty in measurement. (GUM 1995 with minor corrections), BIPM*
- [11] JCGM 200, *International vocabulary of metrology — Basic and general concepts and associated terms (VIM), BIPM*
- [12] JIS Z 2279:1992, *Method of high temperature low cycle fatigue testing for metallic materials [In Japanese]*
- [13] MITCHELL, M.R., *Fundamentals of modern fatigue analysis for design*, ASM Handbook, Fatigue and Fracture, Volume 19, Chapter 18, 1997
- [14] ASTM/STP 465, *Manual on Low Cycle Fatigue Testing*, Ed. R.M. Wetzel, L.F. Coffin, ASTM, 1969
- [15] ASTM/STP 770, *Low-Cycle Fatigue and Life Prediction*, Ed. C. Amzallag, B.N. Leis, P. Rabbe, ASTM, 1982
- [16] *Fatigue at high temperature*, Ed. R.P. Skelton, Elsevier Science Publishers, 1983
- [17] ASTM/STP 942, *Low-cycle fatigue*, Ed. H.D. Solomon, G.R. Halford, L.R. Kaisand, B.N. Leis, ASTM, 1988
- [18] BOLLER, C., SEEGER, T., *Materials data for cyclic loading*, Materials Science Monograph 42, Elsevier Science Publishers, 1987
- [19] *Fatigue design handbook AE-10*, Society of Automotive Engineers, 1988
- [20] THOMAS, G.B., VARMA, R.K., *Review of the BCR/VAMAS low-cycle fatigue intercomparison programme, Harmonisation of testing practice for high temperature materials*, Elsevier Science Publishers, 1992
- [21] VERRILLI, M.J., ELLIS, J.R., SWINDEMAN, R.W., *Current activities in standardization of high temperature low-cycle fatigue testing techniques in the United States, Harmonisation of testing practice for high temperature materials*, Elsevier Science Publishers, 1992

- [22] KITAGAWA, M., YAMAGUCHI K., Japanese activities in VAMAS low-cycle fatigue round robin tests, *Harmonisation of testing practice for high temperature materials*, Elsevier Science Publishers, 1992
- [23] KANDIL, F. A. ET. AL., (eds.) *The UNCERT manual of codes of practice for the determination of uncertainties in mechanical tests on metallic materials*. ISBN 0-946754-41-1, Issue 1, National Physical Laboratory, September 2000. Available online cost-free at: <http://www.npl.co.uk>

Specimens

Cylindrical specimens

- [24] CHABOCHE, J.L., POLICELLA, H., *Caractérisation expérimentale des matériaux sous chargement cyclique à haute température* (Experimental characterization of materials under cyclic loading at high temperature), Recherche Aérospatiale, 1977-5, pp. 307-326
- [25] BRESSERS, J., Strain measurement in high temperature fatigue, *Proceedings of CEC Workshop at the JRC Petten Institute for Energy (NL)*, Elsevier Science Publishers, 1985
- [26] ELLISON, E.G. LOHR, R.D., The extensometer-specimen interface, *Proceedings of HTMTC Symposium "Techniques for High Temperature Fatigue Testing"*, UKAEA, Springfields, 1983
- [27] SUMNER, G., *Uniaxial Testing Machines and Techniques for Fatigue*, HMSO, London, 1982, pp. 158-170
- [28] SHIFFERS, H., Experimental determination of errors in LCF strain measurement caused by specimens with ridges, *Proceedings of CEC Workshop at the JRC Petten Institute for Energy (NL)*, Elsevier Science Publishers, 1985
- [29] CHABOCHE, J.L., *Calcul d'une éprouvette de traction-compression en viscoplasticité cyclique* (Calculations for a tensile-compressive specimen cycled under viscoplastic conditions), Rapport Technique No. 37, ONERA, Dec. 1981

Flat-sheet specimens

- [30] MILLER, G.A., REEMSNYDER, H.S., *Strain-cycle fatigue of sheet and plate steels — Part I: Test method development and data presentation*, SAE Paper 830175, Society of Automotive Engineers, 1983
- [31] MILLER, G.A., REEMSNYDER, H.S., *Strain-cycle fatigue of sheet and plate steels — Part II: Some practical considerations in applying strain-cycle fatigue concepts*, SAE Paper 830173, Society of Automotive Engineers, 1983
- [32] MILLER, G.A., REEMSNYDER, H.S., *Strain-cycle fatigue of sheet and plate steels — Part III: Tests of notched specimens*, SAE Paper 830173, Society of Automotive Engineers, 1983
- [33] MILLER, G.A., Interlaboratory study of strain-cycle fatigue of 1,2 mm thick sheet specimens, *Journal of Testing and Evaluation*, JTEVA, Vol. 13, 5, Sept. 1985, pp. 344-351
- [34] Akihiro Higashi, Kohji Kariya, Norio Kawagoshi, Qiang Chen and Masahiro Oto" Effect of Microstructure on Fatigue Properties of Al Alloys", Advanced Materials Development and Performance (AMDP2011), *Int. Jol. Modern Physics: Conference Series*, Vol. 6, 2012, pp. 300-305

National Annex C

(National Foreword)

<i>Clause/Sub clause</i>	<i>Modifications</i>
6.1.1	However, to reduce the risk of failure outside the extensometer gauge length, the parallel length L_p should not exceed $L_0 + d/2$.
6.1.1	Replace gauge length to parallel length
Table 6 and Annex B	Replace equation: $\frac{\Delta\varepsilon_t}{2} = \frac{\sigma_a}{E} + \left(\frac{\sigma_a}{K'}\right)^{1/n'}$
Table 10	Test conditions - Axial-strain range
Table 10	Replace S_y to σ_y
Figure B.3	Delete first figure

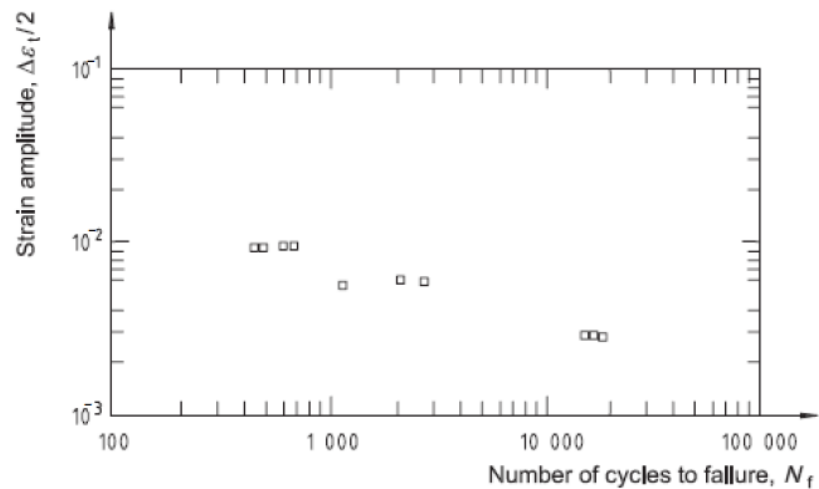

Figure B.4 "Faiture" to be replaced with "Failure" in the X- axis title.

[\(Continued from second cover\)](#)

<i>International Standard</i>	<i>Corresponding Indian Standard</i>	<i>Degree of Equivalence</i>
ISO 9513 Metallic materials — Calibration of extensometer systems used in uniaxial testing	IS 12872 : 2021/ISO 9513 : 2012 Metallic materials — Calibration of extensometer systems used in uniaxial testing (<i>second revision</i>)	Identical

The Committee responsible for the preparation of this standard has reviewed the provisions of following International Standards referred in these adopted standards and decided their acceptability for use in conjunction with this standard.

<i>International Standard</i>	<i>Title</i>
ISO 23788	Metallic materials — Verification of the alignment of fatigue testing machines

In reporting the result of a test or analysis made in accordance with this standard, is to be rounded off, it shall be done in accordance with IS 2 : 2022 'Rules for rounding off numerical-values (*second revision*)'.

Bureau of Indian Standards

BIS is a statutory institution established under the *Bureau of Indian Standards Act, 2016* to promote harmonious development of the activities of standardization, marking and quality certification of goods and attending to connected matters in the country.

Copyright

BIS has the copyright of all its publications. No part of these publications may be reproduced in any form without the prior permission in writing of BIS. This does not preclude the free use, in the course of implementing the standard, of necessary details, such as symbols and sizes, type or grade designations. Enquiries relating to copyright be addressed to the Head (Publication & Sales), BIS.

Review of Indian Standards

Amendments are issued to standards as the need arises on the basis of comments. Standards are also reviewed periodically; a standard along with amendments is reaffirmed when such review indicates that no changes are needed; if the review indicates that changes are needed, it is taken up for revision. Users of Indian Standards should ascertain that they are in possession of the latest amendments or edition by referring to the website-www.bis.gov.in or www.standardsbis.in.

This Indian Standard has been developed from Doc No.: MTD 03 (24421).

Amendments Issued Since Publication

Amend No.	Date of Issue	Text Affected

BUREAU OF INDIAN STANDARDS

Headquarters:

Manak Bhavan, 9 Bahadur Shah Zafar Marg, New Delhi 110002

Telephones: 2323 0131, 2323 3375, 2323 9402

Website: www.bis.gov.in

Regional Offices:

	Telephones
Central : 601/A, Konnectus Tower -1, 6 th Floor, DMRC Building, Bhavbhuti Marg, New Delhi 110002	{ 2323 7617
Eastern : 8 th Floor, Plot No 7/7 & 7/8, CP Block, Sector V, Salt Lake, Kolkata, West Bengal 700091	{ 2367 0012 2320 9474
Northern : Plot No. 4-A, Sector 27-B, Madhya Marg, Chandigarh 160019	{ 265 9930
Southern : C.I.T. Campus, IV Cross Road, Taramani, Chennai 600113	{ 2254 1442 2254 1216
Western : Manakalya, 5 th Floor/MTNL CETTM, Technology Street, Hiranandani Gardens, Powai Mumbai 400076	{ 25700030 25702715

Branches : AHMEDABAD, BENGALURU, BHOPAL, BHUBANESHWAR, CHANDIGARH, CHENNAI, COIMBATORE, DEHRADUN, DELHI, FARIDABAD, GHAZIABAD, GUWAHATI, HARYANA (CHANDIGARH), HUBLI, HYDERABAD, JAIPUR, JAMMU, JAMSHEDPUR, KOCHI, KOLKATA, LUCKNOW, MADURAI, MUMBAI, NAGPUR, NOIDA, PARWANOO, PATNA, PUNE, RAIPUR, RAJKOT, SURAT, VIJAYAWADA.