

प्रक्रिया प्रवाह आरेख, पाइपिंग और
मापयन्त्रण आरेख हेतु आलेखीय प्रतीकों पर
अनुशंसा

(तीसरा पुनरीक्षण)

Recommendations on Graphical
Symbols for Process Flow Diagrams,
Piping and Instrumentation
Diagrams

(Third Revision)

ICS 01.080.30; 23.040.01

© BIS 2024



भारतीय मानक ब्यूरो
BUREAU OF INDIAN STANDARDS
मानक भवन, 9 बहादुर शाह ज़फर मार्ग, नई दिल्ली - 110002
MANAK BHAVAN, 9 BAHADUR SHAH ZAFAR MARG
NEW DELHI - 110002
www.bis.gov.in www.standardsbis.in

FOREWORD

This Indian Standard (Third Revision) was adopted by the Bureau of Indian Standards, after the draft finalized by the Chemical Engineering Plants and Related Equipment Sectional Committee had been approved by the Mechanical Engineering Divisional Council.

Process flow diagrams are widely used in chemical industry as an aid to show basic items of major equipments and their relations to one another in the process scheme. The important flow lines are indicated as connecting items of equipments and help to describe how the process operates.

Piping and instrumentation diagrams are used in the chemical industry to indicate all important aspects such as:

- a) All equipment items;
- b) All instrument items;
- c) All pipelines; and
- d) Important aspects such as insulations, slopes, equipment elevations, etc.

This standard was first published in 1965 and then revised in 1976 and 1999. The present revision has been taken up with a view to incorporate the modification found necessary as a result of experience gained in the use of this standard. Also, in this revision, the standard has been brought into the latest style and format of Indian Standards, and references to Indian Standards, wherever applicable have been updated. In this revision, the following major changes have been made.

The composition of the Committee responsible for the formulation of this standard is given in [Annex A](#).

For the purpose of deciding whether a particular requirement of this standard is complied with the final value, observed or calculated, expressing the result of a test or analysis, shall be rounded off in accordance with IS 2 : 2022 'Rules for rounding off numerical values (*second revision*)'. The number of significant places retained in the rounded off value should be the same as that of the specified value in this standard.

Indian Standard

RECOMMENDATIONS ON GRAPHICAL SYMBOLS FOR PROCESS FLOW DIAGRAMS, PIPING AND INSTRUMENTATION DIAGRAMS

*(Third Revision)***1 SCOPE**

This standard lays down symbols that are to be used while preparing process flow diagrams as well as piping and instrumentation diagrams in order to represent the major requirements of plant or units in the chemical industry.

2 SYMBOLS

2.1 The symbols indicated here represent only major items of plants. Two or more of the basic symbols may be combined to represent composite units.

2.2 Requirement of symbols has been covered in the following Sections:

Section 01 General

Section 02 Process quantities

Section 03 Piping

Section 04 Valves

Section 05 Fittings

Section 06 Instruments

Section 07 Pumps

Section 08 Compressors

Section 09 Heating and cooling arrangements

Section 10 Furnaces and boilers

Section 11 Process vessels

Section 12 Storage vessels/tanks

Section 13 Dryer

Section 14 Size reduction equipment

Section 15 Separators

Section 16 Filters

Section 17 Centrifuges

Section 18 Stirrers

Section 19 Mixers

Section 20 Feeders

Section 21 Conveyors

Section 22 Transport vehicle

Section 23 Miscellaneous

Section 24 Service fluid codes

Section 25 Insulation/tracings types

SECTION 01 GENERAL

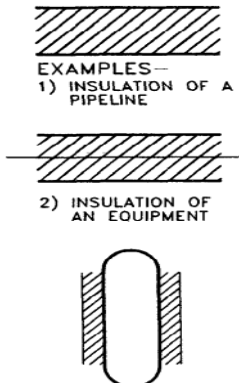
| <i>Sl No.</i> | <i>Symbol No.</i> | <i>Description</i> | <i>Symbols</i> | <i>Remarks</i> |
|---------------|-------------------|-----------------------|--|--|
| (1) | (2) | (3) | (4) | (5) |
| i) | 0101 | Insulation or Tracing |  <p>EXAMPLES— 1) INSULATION OF A PIPELINE 2) INSULATION OF AN EQUIPMENT</p> | <p>Insulation or tracing for equipment and lines are generally not shown symbolically in PFD'S and P & ID'S.</p> <p>In P&ID'S, the letters indicating the type of insulation or tracing are placed on top of the line with or without line number.</p> |

SECTION 02 PROCESS QUANTITIES

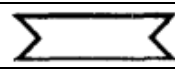
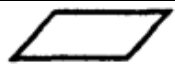
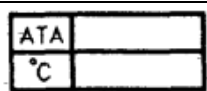
| <i>Sl No.</i> | <i>Symbol No.</i> | <i>Description</i> | <i>Symbols</i> | <i>Remarks</i> |
|---------------|-------------------|--------------------------|---|--|
| (1) | (2) | (3) | (4) | (5) |
| i) | 0201 | Liquid flow |  | Place numerical quantities specified within the symbol |
| ii) | 0202 | Gas flow |  | |
| iii) | 0203 | Pressure and temperature |  | |

SECTION 03 PIPING



| <i>Sl No.</i> | <i>Symbol No.</i> | <i>Description</i> | <i>Symbols</i> | <i>Remarks</i> |
|---------------|-------------------|---------------------------|--|--|
| (1) | (2) | (3) | (4) | (5) |
| i) | 0301 | Inflow line |  | Identify by name |
| ii) | 0302 | Outflow line |  | Identify by name |
| iii) | 0303 | Connecting line |  | — |
| iv) | 0304 | Cross over line |  | — |
| v) | 0305 | Direction of process flow |  | — |
| vi) | 0306 | Slope of a process line |  | Indicates direction but not limits. Degrees are to be shown separately |

Table (Concluded)

| <i>Sl No.</i> | <i>Symbol No.</i> | <i>Description</i> | <i>Symbols</i> | <i>Remarks</i> |
|---------------|-------------------|------------------------------|----------------|---|
| (1) | (2) | (3) | (4) | (5) |
| vii) | 0307 | Dead end | | — |
| viii) | 0308 | Buried line | | — |
| ix) | 0309 | Vendor limit line | | — |
| x) | 0310 | Tracing | | Form of heating to be indicated by initial letter |
| xi) | 0311 | Change of pipe specification | | — |
| xii) | 0312 | Centre line | | — |
| xiii) | 0313 | Coil | | — |
| xiv) | 0314 | Process line | | — |
| xv) | 0315 | Jacketed line | | — |

SECTION 04 VALVE

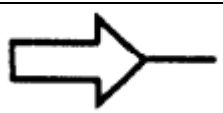
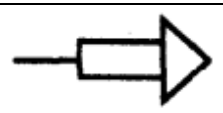
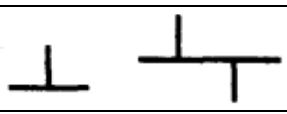
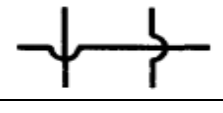
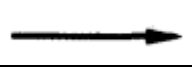
| <i>Sl No.</i> | <i>Symbol No.</i> | <i>Description</i> | <i>Symbols</i> | <i>Remarks</i> |
|---------------|-------------------|--------------------------------------|----------------|----------------|
| (1) | (2) | (3) | (4) | (5) |
| i) | 0401 | Gate valve | | — |
| ii) | 0402 | Globe valve | | — |
| iii) | 0403 | Check valve | | — |
| iv) | 0404 | Angle valve | | — |
| v) | 0405 | Diaphragm valve | | — |
| vi) | 0406 | Safety valve (pressure relief valve) | | — |
| vii) | 0407 | Ball valve | | — |

Table (Continued)











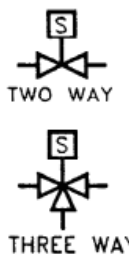

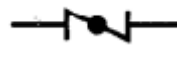

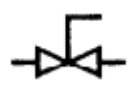



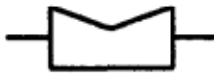

| Sl No. | Symbol No. | Description | Symbols | Remarks |
|--------|------------|---|---|---------|
| (1) | (2) | (3) | (4) | (5) |
| viii) | 0408 | Solenoid valve |  <p>TWO WAY</p> <p>THREE WAY</p> | — |
| ix) | 0409 | Float valve |  | — |
| x) | 0410 | Butterfly valve |  | — |
| xi) | 0411 | Regulating globe valve |  | — |
| xii) | 0412 | Foot valve with strainer |  | — |
| xiii) | 0413 | Plug valve |  | — |
| xiv) | 0414 | Control valve |  | — |
| xv) | 0415 | Piston operated hydraulic control valve |  | — |
| xvi) | 0416 | Electrically operated control valve |  | — |
| xvii) | 0417 | Pinch valve |  | — |
| xviii) | 0418 | Spring loaded valve |  | — |
| xix) | 0419 | Control valve with hand wheel |  | — |
| xx) | 0420 | PCV down stream |  | — |

Table (Concluded)

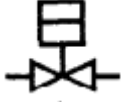
| <i>Sl No.</i> | <i>Symbol No.</i> | <i>Description</i> | <i>Symbols</i> | <i>Remarks</i> |
|---------------|-------------------|------------------------|---|----------------|
| (1) | (2) | (3) | (4) | (5) |
| xxi) | 0421 | PCV up stream |  | — |
| xxii) | 0422 | Hand-operated valve |  | — |
| xxiii) | 0423 | Plunger-operated valve |  | — |
| xxiv) | 0424 | Pilot-operated valve |  | — |
| xxv) | 0425 | 4-way valve |  | — |
| xxvi) | 0426 | Needle valve |  | — |
| xxvii) | 0427 | Positive choke |  | — |
| xxviii) | 0428 | Adjustable choke |  | — |
| xxix) | 0429 | Motor operated valve |  | — |

SECTION 05 FITTINGS

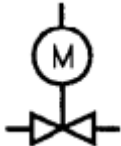

| <i>Sl No.</i> | <i>Symbol No.</i> | <i>Description</i> | <i>Symbols</i> | <i>Remarks</i> |
|---------------|-------------------|--------------------|--|----------------|
| (1) | (2) | (3) | (4) | (5) |
| i) | 0501 | Expansion joint |  | — |
| ii) | 0502 | Hose connector |  | — |
| iii) | 0503 | Flexible hose |  | — |

Table (Continued)





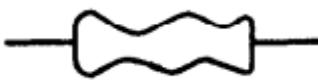



| Sl No. | Symbol No. | Description | Symbols | Remarks |
|--------|------------|----------------------|--|---------|
| (1) | (2) | (3) | (4) | (5) |
| iv) | 0504 | Spectacle blind |  | — |
| v) | 0505 | Line blind |  | — |
| vi) | 0506 | Reducer/Expander |  | — |
| vii) | 0507 | Blind flange |  | — |
| viii) | 0508 | Drain funnel |  | — |
| ix) | 0509 | Threaded cap |  | — |
| x) | 0510 | Orifice |  | — |
| xi) | 0511 | Venturi meter |  | — |
| xii) | 0512 | Steam trap |  | — |
| xiii) | 0513 | Vent with goose neck |  | — |
| xiv) | 0514 | Sight glass |  | — |
| xv) | 0515 | Union |  | — |
| xvi) | 0516 | Coupling |  | — |
| xvii) | 0517 | Adaptor |  | — |
| xviii) | 0518 | Flow-element |  | — |

Table (Continued)

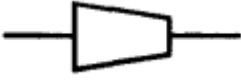
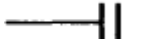

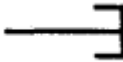
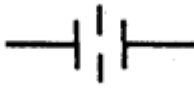

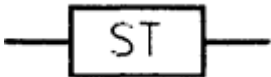

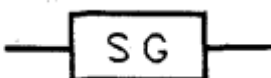
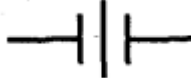
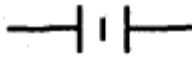
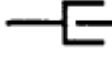
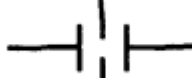



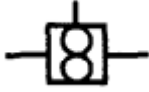
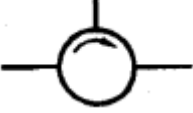
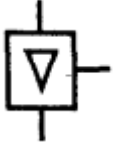

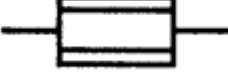
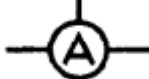

| Sl No. | Symbol No. | Description | Symbols | Remarks |
|---------|------------|---------------------|--|---------|
| (1) | (2) | (3) | (4) | (5) |
| xix) | 0519 | Turbine meter |  | — |
| xx) | 0520 | Pos. disp. meter |  | — |
| xxi) | 0521 | Rotameter |  | — |
| xxii) | 0522 | Sonic meter |  | — |
| xxiii) | 0523 | Magnetic meter |  | — |
| xxiv) | 0524 | Pitot tube |  | — |
| xxv) | 0525 | Drain plugged |  | — |
| xxvi) | 0526 | Drain flanged |  | — |
| xxvii) | 0527 | Straightening vanes |  | — |
| xxviii) | 0528 | Analyser |  | — |
| xxix) | 0529 | Filter |  | — |
| xxx) | 0530 | Filter |  | — |
| xxxi) | 0531 | T-type strainer |  | — |

Table (Concluded)

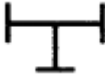
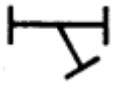
| Sl No. | Symbol No. | Description | Symbols | Remarks |
|----------|------------|--------------------|---|---------|
| (1) | (2) | (3) | (4) | (5) |
| xxxii) | 0532 | Y-type strainer |  | — |
| xxxiii) | 0533 | Temporary |  | — |
| xxxiv) | 0534 | Basket strainer |  | — |
| xxxv) | 0535 | Flame arrester |  | — |
| xxxvi) | 0536 | Cone type strainer |  | — |
| xxxvii) | 0537 | Sample point |  | — |
| xxxviii) | 0538 | Pipe cap welded |  | — |

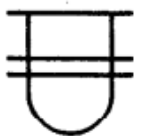
SECTION 06 INSTRUMENTS

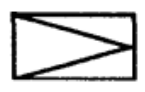
INSTRUMENTATION SYMBOL

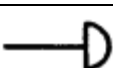



| Sl No. | Symbol No. | Description | Symbols | Remarks |
|--------|------------|-----------------------------|--|---------|
| (1) | (2) | (3) | (4) | (5) |
| i) | 0601 | Instrument air signal |  | — |
| ii) | 0602 | Instrument electric signal |  | — |
| iii) | 0603 | Instrument supply lines |  | — |
| iv) | 0604 | Instrument capillary tubing |  | — |
| v) | 0605 | Hydraulic lines |  | — |
| vi) | 0606 | Software connections |  | — |
| vii) | 0607 | Locally mounted instruments |  | — |

Table (Continued)



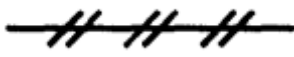

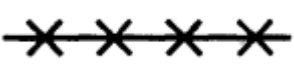
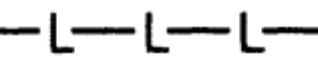
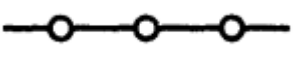















| Sl No. | Symbol No. | Description | Symbols | Remarks |
|--------|------------|-----------------------------------|---|---------|
| (1) | (2) | (3) | (4) | (5) |
| viii) | 0608 | Instrument mounted on main panel |  | — |
| ix) | 0609 | Instrument mounted on local panel |  | — |
| x) | 0610 | Transmitter locally mounted |  | — |
| xi) | 0611 | Transmitter panel mounted |  | — |
| xii) | 0612 | Computer |  | — |
| xiii) | 0613 | Computer local panel |  | — |
| xiv) | 0614 | DCS/DIDC |  | — |
| xv) | 0615 | Gas filter |  | — |
| xvi) | 0616 | Interlock |  | — |
| xvii) | 0617 | Rear panel instrument |  | — |
| xviii) | 0618 | Running light (local) |  | — |
| xix) | 0619 | Running light (panel) |  | — |
| xx) | 0620 | Running light (local panel) |  | — |

Table (Concluded)

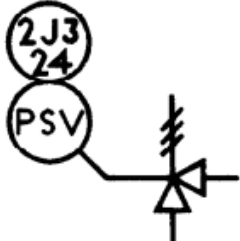
| <i>Sl No.</i> | <i>Symbol No.</i> | <i>Description</i> | <i>Symbols</i> | <i>Remarks</i> |
|---------------|-------------------|---|--|----------------|
| (1) | (2) | (3) | (4) | (5) |
| xxi) | 0621 | Remote telemetric unit |  | — |
| xxii) | 0622 | Inlet size, inches; Orifice code letter; Outlet size, inches; and Safety valve set pressure, kg/cm ² . |  | — |
| xxiii) | 0623 | Rupture disk |  | — |
| xxiv) | 0624 | Rotameter |  | — |
| xxv) | 0625 | Diaphragm seal |  | — |
| xxvi) | 0626 | Breather valve |  | — |
| xxvii) | 0627 | Programmable logic control |  | — |
| xxviii) | 0628 | Programmable logic control on local panel |  | — |

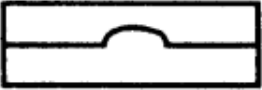
INSTRUMENT LEGEND

(See Table 1 for definition of identification letters)

| <i>Sl No.</i> | <i>Symbol</i> | <i>Definition</i> |
|---------------|---------------|--------------------------------------|
| (1) | (2) | (3) |
| i) | P | Pressure instruments |
| ii) | T | Temperature instruments |
| iii) | L | Level instruments |
| iv) | IL | Interface level instruments |
| v) | F | Flow instruments |
| vi) | A | Analyser instruments |
| vii) | PCV | Self-actuated pressure control valve |
| viii) | TW | Thermowell |

Table (Continued)

| <i>Sl No.</i> | <i>Symbol</i> | <i>Definition</i> |
|---------------|---------------|------------------------------------|
| (1) | (2) | (3) |
| ix) | TE | Temperature element |
| x) | PB | Push button |
| xi) | SOV | Solenoid operated valve |
| xii) | TJI | Multipoint indicator |
| xiii) | DPG | Differential pressure gauge |
| xiv) | DIC | Differential indicating controller |
| xv) | DRC | Differential recording controller |
| xvi) | I | Indicator |
| xvii) | R | Recorder |
| xviii) | IC | Indicating controller |
| xix) | RC | Recording controller |
| xx) | Y | Function (modifier) |
| xxi) | Q | Integrator (summator) |
| xxii) | AL | Alarm low |
| xxiii) | AH | Alarm high |
| xxiv) | ALL | Alarm low |
| xxv) | AHH | Alarm high |
| xxvi) | SL | Switch low |
| xxvii) | SH | Switch high |
| xxviii) | SLL | Switch low |
| xxix) | SHH | Switch high |
| xxx) | PI | Pressure indicator |
| xxxi) | TI | Temperature indicator |
| xxxii) | LI | Level indicator |
| xxxiii) | ILG | Interface level gauge |
| xxxiv) | FE | Flow element |
| xxxv) | AE | Analyser element |
| xxxvi) | PT | Pressure transmitter |
| xxxvii) | LT | Level transmitter |
| xxxviii) | FT | Flow transmitter |
| xxxix) | AT | Analyser transmitter |
| xl) | ILT | Interface level transmitter |
| xli) | PV | Pressure control valve |
| xl ii) | TV | Temperature control valve |
| xl iii) | LV | Level control valve |
| xl iv) | ILV | Interface level control valve |
| xl v) | FV | Flow control valve |
| xl vi) | AV | Gas actuated valve |
| xl vii) | I/P | Current to pneumatic transducer |
| xl viii) | P/I | Pneumatic to current transducer |
| xl ix) | I/E | Current to volts transducer |
| l) | E/I | Volts to current transducer |

Table (Concluded)

| <i>Sl No.</i> | <i>Symbol</i> | <i>Definition</i> |
|---------------|---------------|---|
| (1) | (2) | (3) |
| li) | E/P | Volts to pneumatic transducer |
| lii) | P/E | Pneumatic to volts transducer |
| liii) | SDV | Shut down valve |
| liv) | MOV | Motor operated valve |
| lv) | XL | Running light |
| lvi) | XI | Running indications |
| lvii) | TT | Temperature transmitter |
| lviii) | SC | Sample cooler |
| lix) | UC | Utility connection |
| lx) | FG | Flow class |
| lxi) | PSV | Pressure safety valve |
| lxii) | TSV | Thermal safety valve |
| lxiii) | RD | Rupture disk |
| lxiv) | HIC | Hand indicating controller |
| lxv) | HCV | Hand control valve |
| lxvi) | SS | Selection switch |
| lxvii) | FO | Control valve fail open |
| lxviii) | FC | Control valve fail close |
| lxix) | FL | Control valve fall lock |
| lxx) | TSO | Tight shut off |
| lxxi) | PVRV | Breather valve (pressure vacuum relief valve) |
| lxxii) | AF | Flame arrestor |
| lxxiii) | EX | Excess flow check valve |
| lxxiv) | RTU | Remote terminal unit |
| lxxv) | IJ | Insulation joint |
| lxxvi) | LSS | Low signal selector |
| lxxvii) | MSS | Manual signal selector |
| lxxviii) | LO | Lock open |
| lxxix) | LC | Lock close |
| lxxx) | ZSH | Position switch high (valve open) |
| lxxxi) | ZHH | Position high (valve open) |
| lxxxii) | ZAH | Position alarm high (valve open) |
| lxxxiii) | ZSL | Position switch low (valve close) |
| lxxxiv) | ZLL | Position low (full closed valve) |
| lxxxv) | ZAL | Position alarm low (valve closed) |
| lxxxvi) | FB | Full bore |
| lxxxvii) | NB | Normal bore |
| lxxxviii) | AS | Automatic sampler |
| lxxxix) | DPT | Differential pressure transmitter |
| xc) | FO | Restriction orifice |
| xci) | C | Controller |
| xcii) | UV | On-Off valve |

Table 1 Identification Letters



(Clause 2.2, section 6)

| SI No. | Symbol | First Letter | | Succeeding Letter | | |
|--------|--------|----------------------------------|---------------------|------------------------------|---|---------------------|
| | | Measured or Initiating Variables | Modifier | Read out or Passive Function | Output Function | Modifier |
| (1) | (2) | (3) | (4) | (5) | (6) | (7) |
| i) | A | Analysis | — | Alarm | — | — |
| ii) | B | Burner, combustion | — | User's choice | User's choice | User's choice |
| iii) | C | User's choice | — | — | Control | — |
| iv) | D | User's choice | Differential | — | — | — |
| v) | E | Voltage | — | Sensor (primary element) | — | — |
| vi) | F | Flow rate | Ratio (fraction) | — | — | — |
| vii) | G | User's choice | — | Glass, viewing device | — | — |
| viii) | H | Hand | — | — | — | High |
| ix) | I | Current (electrical) | — | Indicate | — | — |
| x) | J | Power | Scan | — | — | — |
| xi) | K | Time, time schedule | Time rate change | — | Control station | — |
| xii) | L | Level | — | Light | — | Low |
| xiii) | M | User's choice | Momentary | — | — | Middle intermediate |
| xiv) | N | User's choice | — | User's choice | User's choice | User's choice |
| xv) | O | User's choice | — | Office, restriction | — | — |
| xvi) | P | Pressure, vacuum | — | Point (test) connection | — | — |
| xvii) | Q | Quantity | Integrate, totalise | — | — | — |
| xviii) | R | Radiation | — | Record | — | — |
| xix) | S | Speed, frequency | Safety | — | Switch | — |
| xx) | T | Temperature | — | — | Transmit | — |
| xxi) | U | Multivariable | — | Multifunction | Multifunction | Multifunction |
| xxii) | V | Vibration mechanical analysis | — | — | Valve, damper, louver | — |
| xxiii) | W | Weight, force | — | Well | — | — |
| xxiv) | X | Unclassified | X-axis | Unclassified | Unclassified | Unclassified |
| xxv) | Y | Event, state or pressure | Y-axis | — | Relay, compute, convert | — |
| xxvi) | Z | Position, dimension | Z-axis | — | Driver, actuator unclassified final control element | — |

SECTION 07 PUMPS

| Sl No. | Symbol No. | Description | Symbols | Remarks |
|--------|------------|----------------------------|--|---------------------------|
| (1) | (2) | (3) | (4) | (5) |
| i) | 0701 | Centrifugal pumps | <p>PFD SYMBOL</p> <p>P&ID SYMBOL</p> | <p>GEAR PUMP</p> |
| ii) | 0702 | Positive displacement pump | <p>PLUNGER PUMP</p> <p>DUPLEX PUMP</p> | <p>RECIPROCATING PUMP</p> |
| iii) | 0703 | Proportioning pump | | — |
| iv) | 0704 | Hand pump with drum | | — |
| v) | 0705 | Ejector (vapour service) | <p>PROCESS FLUID</p> <p>MOTIVE FLUID</p> | — |
| vi) | 0706 | Blowing egg | | — |

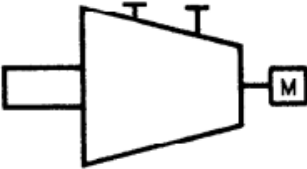
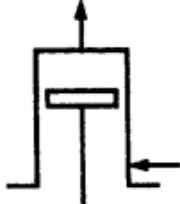
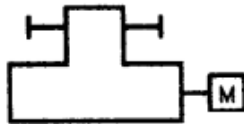
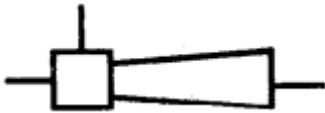
SECTION 08 COMPRESSORS

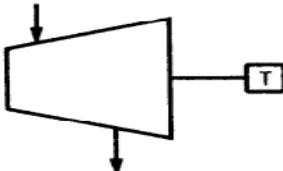
| <i>Sl No.</i> | <i>Symbol No.</i> | <i>Description</i> | <i>Symbols</i> | <i>Remarks</i> |
|---------------|-------------------|----------------------------------|--|----------------|
| (1) | (2) | (3) | (4) | (5) |
| i) | 0801 | Centrifugal compressor |  | — |
| ii) | 0802 | Positive displacement compressor |  | — |
| iii) | 0803 | Reciprocating compressor |  | — |
| iv) | 0804 | Ejector compressor |  | — |
| v) | 0805 | Fan |  | — |
| vi) | 0806 | Turbine |  | — |

SECTION 09 HEATING OR COOLING ARRANGEMENTS



| <i>Sl No.</i> | <i>Symbol No.</i> | <i>Description</i> | <i>Symbols</i> | <i>Remarks</i> |
|---------------|-------------------|--------------------|--|---|
| (1) | (2) | (3) | (4) | (5) |
| i) | 0901 | Immersion coil |   | <p>EXAMPLES—</p>   |

Table (Continued)







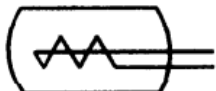
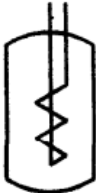

| Sl No. | Symbol No. | Description | Symbols | Remarks |
|--------|------------|----------------------------|--|---|
| (1) | (2) | (3) | (4) | (5) |
| ii) | 0902 | Exchanger (in PFD) |  | — |
| iii) | 0903 | Heat exchanger |  | — |
| iv) | 0904 | Exchanger |  | — |
| v) | 0905 | Exchanger |  | — |
| vi) | 0906 | Kettle reboiler |  | — |
| vii) | 0907 | Kettle reboiler |  | — |
| viii) | 0908 | Kettle reboiler 2 – bundle |  | — |
| ix) | 0909 | Tubular coil |  | EXAMPLE :-  |
| x) | 0910 | Jacket |  | EXAMPLE :-  |

Table (Continued)

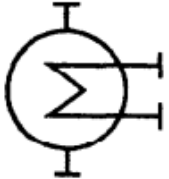
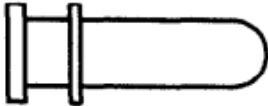

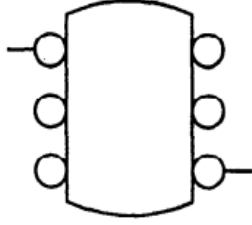

| Sl No. | Symbol No. | Description | Symbols | Remarks |
|--------|------------|-------------------------------|--|--------------|
| (1) | (2) | (3) | (4) | (5) |
| xi) | 0911 | Natural draught cooling tower |  | — |
| xii) | 0912 | Induced draught cooling tower |  | — |
| xiii) | 0913 | Air blown cooler |  | Used for PFD |
| xiv) | 0914 | Trickle cooler |  | — |
| xv) | 0915 | Plate type heat exchanger |  | — |
| xvi) | 0916 | Air cooler with fan and motor |  | Used for P&I |
| xvii) | 0917 | Contact condenser |  | — |
| xviii) | 0918 | Desuper heater |  | — |

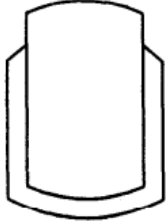
Table (Concluded)

| <i>Sl No.</i> | <i>Symbol No.</i> | <i>Description</i> | <i>Symbols</i> | <i>Remarks</i> |
|---------------|-------------------|-------------------------------|--|----------------|
| (1) | (2) | (3) | (4) | (5) |
| xix) | 0919 | One cell fired heater/furnace |  | — |
| xx) | 0920 | Two cell fired heater/furnace |  | — |

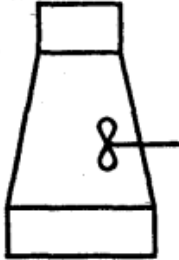
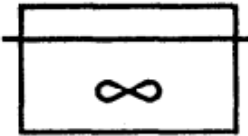
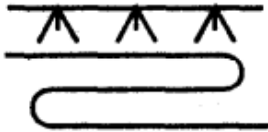
SECTION 10 FURNACES AND BOILERS

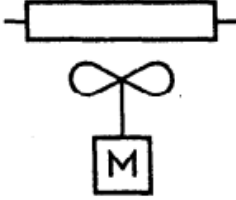
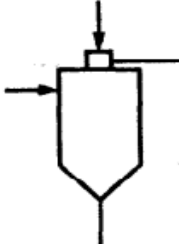
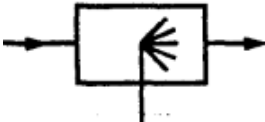
| <i>Sl No.</i> | <i>Symbol No.</i> | <i>Description</i> | <i>Symbols</i> | <i>Remarks</i> |
|---------------|-------------------|-------------------------------------|--|----------------|
| (1) | (2) | (3) | (4) | (5) |
| i) | 1001 | Solid fuel furnace |  | — |
| ii) | 1002 | Oil, gas or pulverized fuel furnace |  | — |
| iii) | 1003 | Electric furnace |  | — |
| iv) | 1004 | Fired boiler |  | — |
| v) | 1005 | Waste heat boiler |  | — |

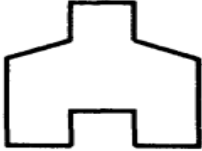
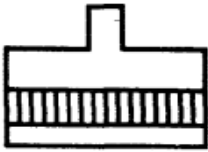
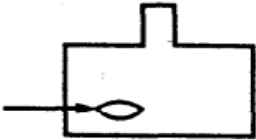
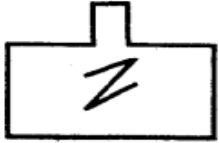
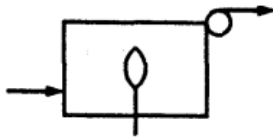
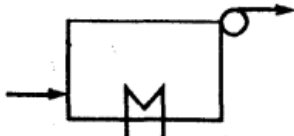
SECTION 11 PROCESS VESSELS







| <i>Sl No.</i> | <i>Symbol No.</i> | <i>Description</i> | <i>Symbols</i> | <i>Remarks</i> |
|---------------|-------------------|---|---|----------------|
| (1) | (2) | (3) | (4) | (5) |
| i) | 1101 | Horizontal vessel |  | — |
| ii) | 1102 | Vertical vessel |  | — |
| iii) | 1103 | Jacketed vessel |  | — |
| iv) | 1104 | Packed vessel |  | — |
| v) | 1105 | Evaporator |  | — |
| vi) | 1106 | Crystallizer |  | — |
| vii) | 1107 | Autoclave |  | — |
| viii) | 1108 | Construction inside containers, columns towers and reactors | | — |

Table (Continued)

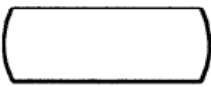

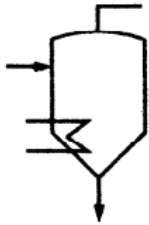
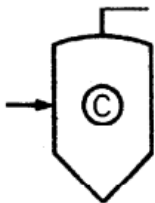

| Sl No. | Symbol No. | Description | Symbols | Remarks |
|--------|------------|----------------------------------|--|---|
| (1) | (2) | (3) | (4) | (5) |
| ix) | 1108A | Plates/trays (for mass transfer) |  |  <p><i>Example:</i> Tray should be numbered from the bottom at least the first and last should be shown. Intermediate tray should be included and numbered where they are significant.</p> |
| x) | 1108B | Fluidized bed |  | |
| xi) | 1109 | Multi bed packed column |  | — |
| xii) | 1110 | Vessel with boot |  | — |
| xiii) | 1111 | Deaerator |  | — |
| xiv) | 1112 | Flanged vessel |  | — |
| xv) | 1113 | Double flanged vessel |  | — |
| xvi) | 1114 | Conical bottom vessel |  | — |

Table (Concluded)

| <i>Sl No.</i> | <i>Symbol No.</i> | <i>Description</i> | <i>Symbols</i> | <i>Remarks</i> |
|---------------|-------------------|-----------------------|--|----------------|
| (1) | (2) | (3) | (4) | (5) |
| xvii) | 1115 | Vessel with one-sump |  | — |
| xviii) | 1116 | Vessel with two-sumps |  | — |

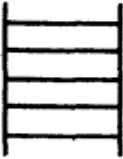
SECTION 12 STORAGE VESSELS/TANKS

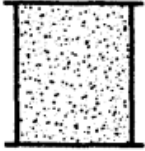
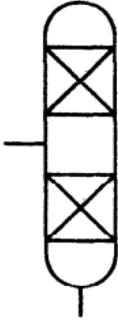
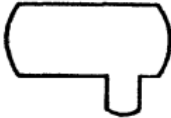
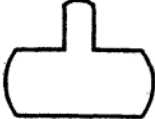
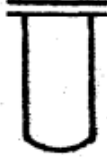
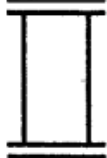
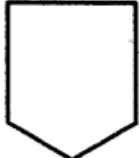
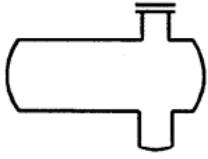
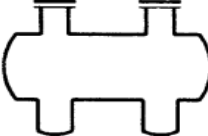
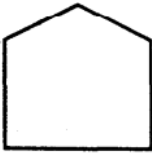
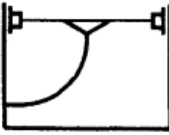
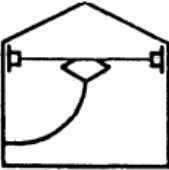
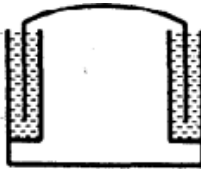
| <i>Sl No.</i> | <i>Symbol No.</i> | <i>Description</i> | <i>Symbols</i> | <i>Remarks</i> |
|---------------|-------------------|---|--|----------------|
| (1) | (2) | (3) | (4) | (5) |
| i) | 1201 | Fixed roof tank |  | — |
| ii) | 1202 | Floating roof tank |  | — |
| iii) | 1203 | Floating cum fixed roof tank |  | — |
| iv) | 1204 | Gas holder, wet seal |  | — |
| v) | 1205 | Gas holder, dry seal |  | — |
| vi) | 1206 | Pressure storage (sphere or spheroid) Horton sphere |  | — |

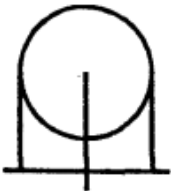
SECTION 13 DRYERS

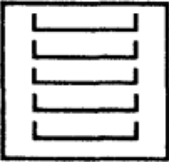
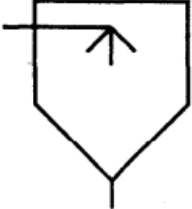
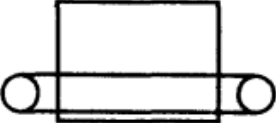
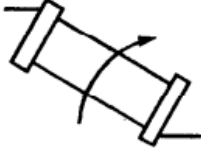
| <i>Sl No.</i> | <i>Symbol No.</i> | <i>Description</i> | <i>Symbols</i> | <i>Remarks</i> |
|---------------|-------------------|----------------------|---|----------------|
| (1) | (2) | (3) | (4) | (5) |
| i) | 1301 | Batch tray drier |  | — |
| ii) | 1302 | Spray drier |  | — |
| iii) | 1303 | Continuous drier |  | — |
| iv) | 1304 | Rotary drier or kiln |  | — |

SECTION 14 SIZE REDUCTION EQUIPMENTS







| <i>Sl No.</i> | <i>Symbol No.</i> | <i>Description</i> | <i>Symbols</i> | <i>Remarks</i> |
|---------------|-------------------|---|--|----------------------------|
| (1) | (2) | (3) | (4) | (5) |
| i) | 1401 | Size reducing equipment (general symbol) |  | <i>Example: Pulverizer</i> |
| ii) | 1402 | Breaker, gyratory |  | — |
| iii) | 1403 | Breaker hammer mill impact mill |  | — |

Table (Concluded)

| Sl No. | Symbol No. | Description | Symbols | Remarks |
|--------|------------|-------------------|---|---------|
| (1) | (2) | (3) | (4) | (5) |
| iv) | 1404 | Jaw crusher |  | — |
| v) | 1404A | Roller crusher |  | — |
| vi) | 1405 | Grinder |  | — |
| vii) | 1406 | Ball or Tube mill |  | — |

SECTION 15 SEPARATORS

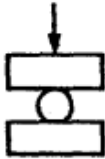
| Sl No. | Symbol No. | Description | Symbols | Remarks |
|--------|------------|--|--|---------|
| (1) | (2) | (3) | (4) | (5) |
| i) | 1501 | Cyclone or hydrocyclone |  | — |
| ii) | 1502 | Electrostatic separator (electrical purification of gas) |  | — |
| iii) | 1503 | Separators for liquids, decanters |  | — |

Table (Concluded)

| Sl No. | Symbol No. | Description | Symbols | Remarks |
|--------|------------|-------------|---|---|
| (1) | (2) | (3) | (4) | (5) |
| iv) | 1504 | Thickener |  | — |
| v) | 1505 | Screen | <p>SCREEN, VIBRATORY</p>  | <p>SCREEN, ROTARY</p>  |

SECTION 16 FILTERS



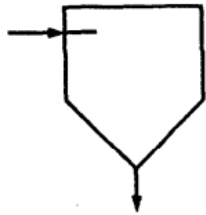
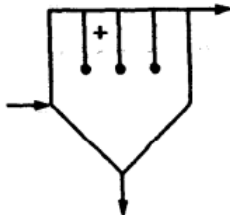
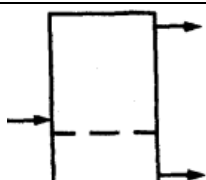
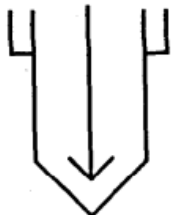
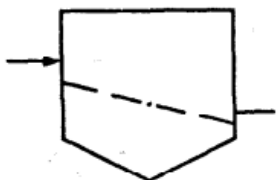
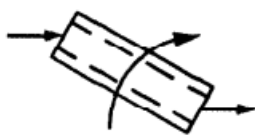

| Sl No. | Symbol No. | Description | Symbols | Remarks |
|--------|------------|-------------------------------------|--|---------|
| (1) | (2) | (3) | (4) | (5) |
| i) | 1601 | Filter press |  | — |
| ii) | 1602 | Suction filter |  | — |
| iii) | 1603 | Pressure filter |  | — |
| iv) | 1604 | Gravity filter (open settling tank) |  | — |
| v) | 1605 | Open rotary vacuum filter |  | — |
| vi) | 1606 | Closed rotary vacuum filter |  | — |

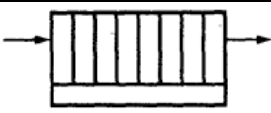
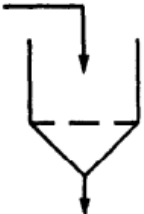
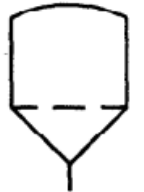
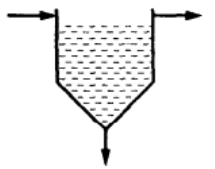

Table (Concluded)

| <i>Sl No.</i> | <i>Symbol No.</i> | <i>Description</i> | <i>Symbols</i> | <i>Remarks</i> |
|---------------|-------------------|--------------------|---|--|
| (1) | (2) | (3) | (4) | (5) |
| vii) | 1607 | Bag filter |  | BASKET FILTER  |



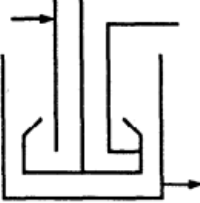
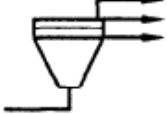
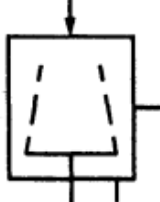
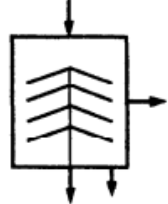

SECTION 17 CENTRIFUGES

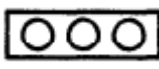
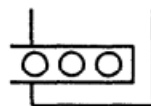
| <i>Sl No.</i> | <i>Symbol No.</i> | <i>Description</i> | <i>Symbols</i> | <i>Remarks</i> |
|---------------|-------------------|---------------------------------------|---|--|
| (1) | (2) | (3) | (4) | (5) |
| i) | 1701 | Centrifuges (general symbol) |  | ALTERNATIVE  |
| ii) | 1702 | Basket centrifuge batch or continuous |  | — |
| iii) | 1703 | Plate centrifuge |  | — |

SECTION 18 STIRRERS

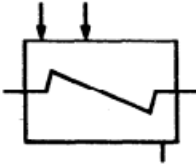
| <i>Sl No.</i> | <i>Symbol No.</i> | <i>Description</i> | <i>Symbols</i> | <i>Remarks</i> |
|---------------|-------------------|--------------------|---|--|
| (1) | (2) | (3) | (4) | (5) |
| i) | 1801 | General symbol |  | EXAMPLE:-  |
| ii) | 1802 | Sparger |  | EXAMPLE:-  |

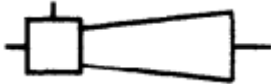
SECTION 19 MIXERS

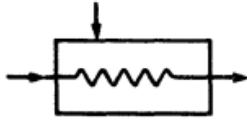
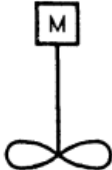
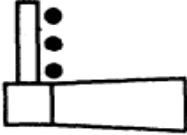
| <i>Sl No.</i> | <i>Symbol No.</i> | <i>Description</i> | <i>Symbols</i> | <i>Remarks</i> |
|---------------|-------------------|---------------------|--|----------------|
| (1) | (2) | (3) | (4) | (5) |
| i) | 1901 | Ribbon blender |  | — |
| ii) | 1902 | Kneader |  | — |
| iii) | 1903 | Double cone blender |  | — |
| iv) | 1904 | Ejector mixer |  | — |
| v) | 1905 | Rotary mixer |  | — |
| vi) | 1906 | On-line mixer |  | — |
| vii) | 1907 | Mixer |  | — |
| viii) | 1908 | Saucony mixer |  | — |

SECTION 20 FEEDERS

| <i>Sl No.</i> | <i>Symbol No.</i> | <i>Description</i> | <i>Symbols</i> | <i>Remarks</i> |
|---------------|-------------------|--------------------|---|----------------|
| (1) | (2) | (3) | (4) | (5) |
| i) | 2001 | General symbol |  | — |

Table (Concluded)

| <i>Sl No.</i> | <i>Symbol No.</i> | <i>Description</i> | <i>Symbols</i> | <i>Remarks</i> |
|---------------|-------------------|---|---|----------------|
| (1) | (2) | (3) | (4) | (5) |
| ii) | 2002 | Vibrator feeder |  | — |
| iii) | 2003 | Weigh feeder |  | — |
| iv) | 2004 | Rotary table feeder, revolving plate feeder |  | — |
| v) | 2005 | Scraper feeder |  | — |
| vi) | 2006 | Screw feeder |  | — |
| vii) | 2007 | Rotary feeder |  | — |

SECTION 21 CONVEYORS



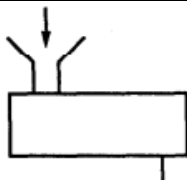
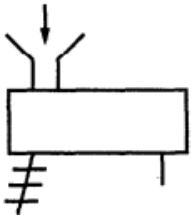
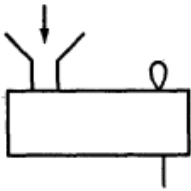
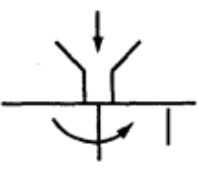
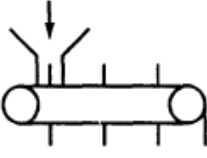
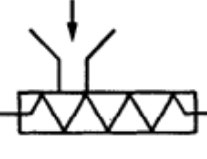
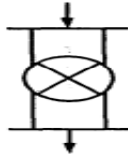

| <i>Sl No.</i> | <i>Symbol No.</i> | <i>Description</i> | <i>Symbols</i> | <i>Remarks</i> |
|---------------|-------------------|--------------------|--|----------------|
| (1) | (2) | (3) | (4) | (5) |
| i) | 2101 | Belt conveyor |  | — |
| ii) | 2102 | Scraper conveyor |  | — |

Table (Concluded)

| Sl No. | Symbol No. | Description | Symbols | Remarks |
|--------|------------|---|--|---------|
| (1) | (2) | (3) | (4) | (5) |
| iii) | 2103 | Vibrating conveyer |  | — |
| iv) | 2104 | Screw conveyer |  | — |
| v) | 2105 | Bucket conveyer |  | — |
| vi) | 2106 | Roller conveyer |  | — |
| vii) | 2107 | Overhead conveyer with hooks |  | — |
| viii) | 2107B | Overhead conveyer or ropeway with buckets or carriers |  | — |
| ix) | 2108A | Fixed hoist with hook |  | — |
| x) | 2108B | Travelling hoist with hook |  | — |
| xi) | 2108C | Travelling hoist with grab |  | — |
| xii) | 2108D | Air floats |  | — |

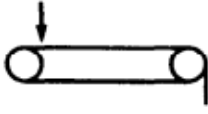
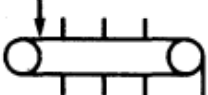
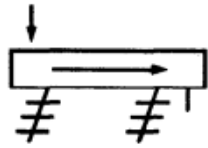
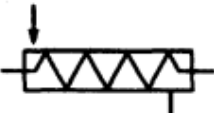
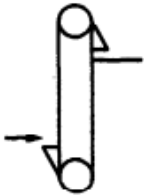
SECTION 22 TRANSPORT VEHICLES

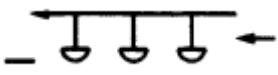

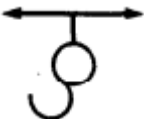
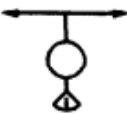
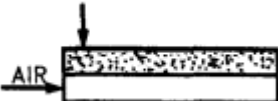
| Sl No. | Symbol No. | Description | Symbols | Remarks |
|--------|------------|-------------|---|---------|
| (1) | (2) | (3) | (4) | (5) |
| i) | 2201 | Ship |  | — |

Table (Concluded)

| <i>Sl No.</i> | <i>Symbol No.</i> | <i>Description</i> | <i>Symbols</i> | <i>Remarks</i> |
|---------------|-------------------|--------------------------|--|----------------|
| (1) | (2) | (3) | (4) | (5) |
| ii) | 2202 | Wagon, lorry, truck |  | — |
| iii) | 2203 | Tanker |  | — |
| iv) | 2204 | Open trailer |  | — |
| v) | 2205 | Wagon with bottom hopper |  | — |

SECTION 23 MISCELLANEOUS

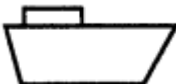
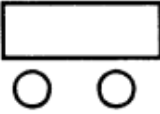
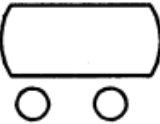
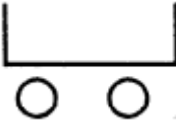
| <i>Sl No.</i> | <i>Symbol No.</i> | <i>Description</i> | <i>Symbols</i> | <i>Remarks</i> |
|---------------|-------------------|--------------------|--|----------------|
| (1) | (2) | (3) | (4) | (5) |
| i) | 2301 | Silencer |  | — |
| ii) | 2302 | Launcher receiver |  | — |
| iii) | 2303 | Diesel generator |  | — |
| iv) | 2304 | Turbine generator |  | — |

Table (Continued)



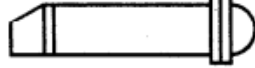
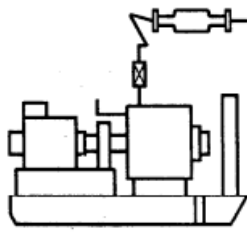
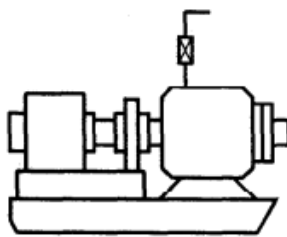

| Sl No. | Symbol No. | Description | Symbols | Remarks |
|--------|------------|---|--|---------|
| (1) | (2) | (3) | (4) | (5) |
| v) | 2305 | Hose reel |  | |
| vi) | 2306A | Well head with one bore (single completion) |  | — |
| vii) | 2306B | Well head with two bore (dual completion) |  | — |
| viii) | 2307 | Sump caisson |  | — |
| ix) | 2308 | Flare |  | — |
| x) | 2308B | Flare stack |  | — |

Table (Continued)



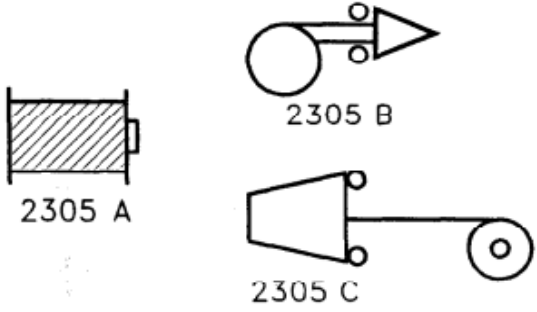

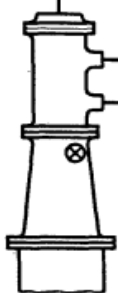
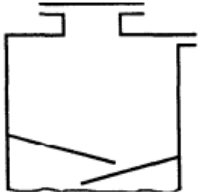
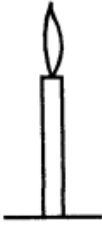

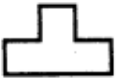

| <i>Sl No.</i> | <i>Symbol No.</i> | <i>Description</i> | <i>Symbols</i> | <i>Remarks</i> |
|---------------|-------------------|-------------------------------------|--|----------------|
| (1) | (2) | (3) | (4) | (5) |
| xi) | 2309 | Chimney |  | — |
| xii) | 2310 | Scraper tee |  | — |
| xiii) | 2311 | Atmospheric vent |  | — |
| xiv) | 2312 | Cylinder |  | — |
| xv) | 2313 | Graduated cylinder |  | — |
| xvi) | 2314 | Crane |  | — |
| xvii) | 2315A | Electrolytic cell without diaphragm |  | — |
| xviii) | 2315B | Electrolytic cell with diaphragm |  | — |
| xix) | 2316 | Turbine drive |  | — |
| xx) | 2317 | Motor drive |  | — |

Table (Concluded)

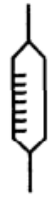
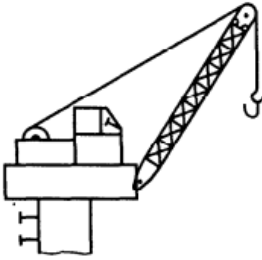
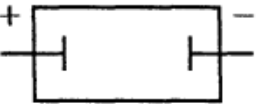
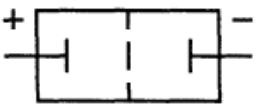
| <i>Sl No.</i> | <i>Symbol No.</i> | <i>Description</i> | <i>Symbols</i> | <i>Remarks</i> |
|---------------|-------------------|--------------------|--|---|
| (1) | (2) | (3) | (4) | (5) |
| xxi) | 2318 | Swivel drain |  | — |
| xxii) | 2319 | CBD-symbol |  | — |
| xxiii) | 2320 | Sample cooler |  |  |

SECTION 24 SERVICE FLUID CODES

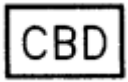
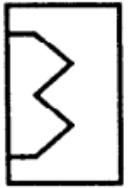
| <i>Sl No.</i> | <i>Codes</i> | <i>Meaning</i> |
|---------------|--------------|-----------------------|
| (1) | (2) | (3) |
| i) | P | Process |
| ii) | WCS | Cooling water supply |
| iii) | WCR | Cooling water return |
| iv) | WD | Drinking water |
| v) | WS | Service water |
| vi) | WF | Fire water |
| vii) | WR | Raw water |
| viii) | WP | Process water |
| ix) | WT | Treated water |
| x) | AI | Instrument air |
| xi) | AP | Plant air |
| xii) | AB | Breathing air |
| xiii) | BD | Blow down |
| xiv) | FL | Flare |
| xv) | FO | Fuel oil |
| xvi) | FG | Fuel gas |
| xvii) | GI | Instrument gas |
| xviii) | IG | Inert gas |
| xix) | OWS | Only water sewer |
| xx) | SS | Strom sever |
| xxi) | CBD | Closed blow down |
| xxii) | D | Drain |
| xxiii) | UC | Utility connection |
| xxiv) | HM | Heating medium |
| xxv) | HMS | Heating medium supply |
| xxvi) | HMR | Heating medium return |

Table (Concluded)

| <i>Sl No.</i> | <i>Codes</i> | <i>Meaning</i> |
|---------------|--------------|------------------------|
| (1) | (2) | (3) |
| xxvii) | EG | 50 percent EG solution |
| xxviii) | CHWS | Chilled water supply |
| xxix) | CHWR | Chilled water return |
| xxx) | WDM | Demineralised water |
| xxxi) | SH | SP steam |
| xxxii) | SM | MP steam |
| xxxiii) | SL | LP steam |
| xxxiv) | CH | Condensate HP |
| xxxv) | CM | Condensate MP |
| xxxvi) | CL | Condensate LP |
| xxxvii) | N | Nitrogen |
| xxxviii) | BR | Brine |
| xxxix) | CS | Caustic sewer |
| xl) | NA | Caustic |
| xli) | RE | Refrigerant ethane |
| xlii) | RA | Refrigerant ammonia |
| xliii) | RP | Refrigerant propane |
| xliv) | AC | Acid lines |

SECTION 25 INSULATION/TRACING TYPE

| <i>Sl No.</i> | <i>Codes</i> | <i>Meaning</i> |
|---------------|--------------|-----------------------|
| (1) | (2) | (3) |
| i) | IH | Hot insulation |
| ii) | IC | Cold insulation |
| iii) | IS | Safety insulation |
| iv) | IT | Steam traced |
| v) | IE | Electric traced |
| vi) | IA | Acoustic insulation |
| vii) | IF | Thermal fluid tracing |

ANNEX A

(Foreword)

COMMITTEE COMPOSITION

Chemical Engineering Plants and Related Equipment Sectional Committee, MED 17

| <i>Organization</i> | <i>Representative(s)</i> |
|--|---|
| CSIR - Indian Institute of Petroleum, Dehradun | DR MRITUNJAY KUMAR SHUKLA (<i>Chairperson</i>) |
| Advance Valves Global, Noida | SHRI PRANAY S. GARG SHRI CHANDRAKANT WADKAR (<i>Alternate</i>) |
| Auma India Private Limited, Bengaluru | SHRI YASHWANT M. JANNU |
| Bharat Heavy Electrical Limited, New Delhi | SHRI Y. SRINIVASA RAO SHRI ABHISHEK KUMAR PANDEY (<i>Alternate</i>) |
| Blast Carboblocks Private Limited, Mumbai | SHRI DHAWAL SAXENA |
| Central Power Research Institute, Bengaluru | DR P. THOMAS SHRI SADASIVA MURTHY P. (<i>Alternate I</i>) SHRI AJITH KUMAR N. (<i>Alternate II</i>) |
| Chemtrols Industries Private Limited, New Delhi | SHRI P. KRISHNA KUMAR |
| Confederation of Indian Industry, New Delhi | SHRI NANDAKUMAR KALATH SHRI ABILASH UTTAM (<i>Alternate</i>) |
| Directorate General Factory Advice Service and Labour Institutes, Mumbai | SHRI TANOJ CHANDAN SHRI KUNAL SHARMA (<i>Alternate</i>) |
| Engineers India Limited, Gurugram | SHRI HASMUKH K. PARMAR SHRI MRAGANG SHEAKHAR (<i>Alternate</i>) |
| GMM Pfaudler Limited, Anand | SHRI DHIRAN PANCHAL SHRI SATVIK PATEL (<i>Alternate</i>) |
| Hindustan Petroleum Corporation Limited, Mumbai | SHRI KRISHANU GHOSH SHRI N.K. RAI (<i>Alternate</i>) |
| Indian Oil Corporation Limited, New Delhi | SHRI KARAN AGRAWAL |
| Indian Rubber Manufacturers Research Association, Mumbai | DR K. RAJ KUMAR DR DEBDIPTA BASU (<i>Alternate</i>) |
| Indian Valve and Actuator Manufacturers Association (IVAMA), Coimbatore | SHRI R. MURUGANANTHAM SHRI JAY DOSHI (<i>Alternate</i>) |
| Kejriwal Casting Limited, Kolkata | SHRI SANDEEP KEJRIWAL |
| L&T Valves, Chennai | SHRI ROHIT SHARMA SHRI SURIYANARAYANAN (<i>Alternate</i>) |
| Lathia Rubber Manufacture Company Private Limited, Mumbai | SHRI SANJIV S. LATHIA |
| MECON Limited, Ranchi | SHRI YOGENDRA KUMAR SINGH SHRI ARVIND BHUSHAN (<i>Alternate</i>) |

| <i>Organization</i> | <i>Representative(s)</i> |
|--|---|
| Plastics Machinery Manufacturers Association of India (PMMAI), New Delhi | SHRI NANDHA KUMAR T. SHRI PRADIP VANWANI (<i>Alternate</i>) |
| Project and Development India Limited, Noida | SHRI SANJIV KUMAR MISHRA SHRI RAJEEV RANJAN KUMAR (<i>Alternate</i>) |
| Tata Consulting Engineers Limited, Navi Mumbai | SHRI SHIVNARAYAN PAREEK SHRI SHIREESH S. SWAMI (<i>Alternate</i>) |
| BIS Directorate General | SHRI NAVINDRA GAUTAM SCIENTIST 'E'/DIRECTOR AND HEAD (MECHANICAL ENGINEERING) [REPRESENTING DIRECTOR GENERAL (<i>Ex-officio</i>)] |

Member Secretary
MS NEHA THAKUR
SCIENTIST 'B'/ASSISTANT DIRECTOR
(MECHANICAL ENGINEERING), BIS

Bureau of Indian Standards

BIS is a statutory institution established under the *Bureau of Indian Standards Act, 2016* to promote harmonious development of the activities of standardization, marking and quality certification of goods and attending to connected matters in the country.

Copyright

BIS has the copyright of all its publications. No part of these publications may be reproduced in any form without the prior permission in writing of BIS. This does not preclude the free use, in the course of implementing the standard, of necessary details, such as symbols and sizes, type or grade designations. Enquiries relating to copyright be addressed to the Head (Publication & Sales), BIS.

Review of Indian Standards

Amendments are issued to standards as the need arises on the basis of comments. Standards are also reviewed periodically; a standard along with amendments is reaffirmed when such review indicates that no changes are needed; if the review indicates that changes are needed, it is taken up for revision. Users of Indian Standards should ascertain that they are in possession of the latest amendments or edition by referring to the website-www.bis.gov.in or www.standardsbis.in.

This Indian Standard has been developed from Doc No.: MED 17 (19915).

Amendments Issued Since Publication

| Amend No. | Date of Issue | Text Affected |
|-----------|---------------|---------------|
| | | |
| | | |
| | | |
| | | |

BUREAU OF INDIAN STANDARDS

Headquarters:

Manak Bhavan, 9 Bahadur Shah Zafar Marg, New Delhi 110002

Telephones: 2323 0131, 2323 3375, 2323 9402

Website: www.bis.gov.in

Regional Offices:

| | Telephones |
|---|--------------------------|
| Central : 601/A, Konnectus Tower -1, 6 th Floor, DMRC Building, Bhavbhuti Marg, New Delhi 110002 | { 2323 7617 |
| Eastern : 8 th Floor, Plot No 7/7 & 7/8, CP Block, Sector V, Salt Lake, Kolkata, West Bengal 700091 | { 2367 0012 2320 9474 |
| Northern : Plot No. 4-A, Sector 27-B, Madhya Marg, Chandigarh 160019 | { 265 9930 |
| Southern : C.I.T. Campus, IV Cross Road, Taramani, Chennai 600113 | { 2254 1442 2254 1216 |
| Western : Plot No. E-9, Road No.-8, MIDC, Andheri (East), Mumbai 400093 | { 2821 8093 |

Branches : AHMEDABAD. BENGALURU. BHOPAL. BHUBANESHWAR. CHANDIGARH. CHENNAI. COIMBATORE. DEHRADUN. DELHI. FARIDABAD. GHAZIABAD. GUWAHATI. HIMACHAL PRADESH. HUBLI. HYDERABAD. JAIPUR. JAMMU & KASHMIR. JAMSHEDPUR. KOCHI. KOLKATA. LUCKNOW. MADURAI. MUMBAI. NAGPUR. NOIDA. PANIPAT. PATNA. PUNE. RAIPUR. RAJKOT. SURAT. VISAKHAPATNAM.