

एसोसिएटेड इलेक्ट्रिक पावर सिस्टम
इंटरफेस के साथ वितरित ऊर्जा संसाधनों
का अंतः संबन्धन और अन्तरसंक्रियता

Interconnection and
Interoperability of Distributed
Energy Resources with Associated
Electric Power Systems Interfaces

ICS 29.240.01

J BIS 2024
J IEC 2018



भारतीय मानक ब्यूरो

BUREAU OF INDIAN STANDARDS
मानक भवन, 9 बहादुर शाह ज़फर मार्ग, नई दिल्ली - 110002
MANAK BHAVAN, 9 BAHADUR SHAH ZAFAR MARG
NEW DELHI - 110002

www.bis.gov.in www.standardsbis.in

NATIONAL FOREWORD

This Indian Standard which is modified adoption of IEEE Std 1547-2018 'IEEE standard for interconnection and interoperability of distributed energy resources with associated electric power systems interfaces' issued by the Institute of Electrical and Electronics Engineers was adopted by the Bureau of Indian Standards on the recommendation of the Grid Integration of Renewables Sectional Committee and approval of the Electrotechnical Division Council.

This standard is made available under license from IEEE and is an adoption of IEEE Std 1547-2018 'IEEE standard for interconnection and interoperability of distributed energy resources with associated electric power systems interfaces', 445 Hoes Lane Piscataway, NJ, 08854, USA.

This Indian National Standard is only valid in India as an Indian National Standard. No changes have been made to the adopted IEEE standard except those that may be included as country-specific changes in a front matter or an attached informative annexure. India specific changes have been made to the adopted IEEE standard as outlined in [National Annex J](#).

The text of IEEE standard has been approved as suitable for publication as an Indian Standard without deviations. Certain terminology and conventions are however not identical to those used in Indian Standards. Attention is particularly drawn to the following:

Wherever the words 'IEEE standard' appear referring to this standard, they should be read as 'Indian Standard'; and

- a) Wherever the words 'IEEE Standard' appear referring to this standard, they should be read as 'Indian Standard'; and
- b) Comma (,) has been used as a decimal marker, while in Indian Standards the current practice is to use a point (.) as the decimal marker.

In this adopted standard, references appear to the following International Standards for which Indian Standards also exist. The corresponding Indian Standard which is to be substituted in place, is listed below along with their degree of equivalence for the editions indicated:

<i>International Standard</i>	<i>Corresponding Indian Standard</i>	<i>Degree of Equivalence</i>
IEC 61000-4-3 Electromagnetic compatibility (EMC) — Part 4-3: Testing and measurement techniques — Radiated, radio-frequency, electromagnetic field immunity test	IS 14700 (Part 4/Sec 3) : 2023/ IEC 61000-4-3 : 2020 Electromagnetic Compatibility (EMC): Part 4 Testing and Measurement Techniques, Section 3 Radiated, radio-frequency electromagnetic field immunity test (<i>second revision</i>)	Identical
IEC 61000-4-5 Electromagnetic compatibility (EMC) — Part 4-5: Testing and measurement techniques — Surge immunity test	IS 14700 (Part 4/Sec 5) : 2019/ IEC 61000-4-5 : 2017 Electromagnetic compatibility (EMC): Part 4 Testing and measurement techniques, Section 5 Surge immunity test (<i>first revision</i>)	Identical

The Committee has reviewed the provisions of the following International Standards/Other Publications referred in this adopted standard and has decided that they are acceptable for use in conjunction with this standard:

<i>International Standard</i>	<i>Title</i>
IEC/TR 61000-3-7	Electromagnetic compatibility (EMC) — Part 3-7: Limits — Assessment of emission limits for the connection of fluctuating installations to MV, HV and EHV power systems
IEEE Std 519™	IEEE recommended practices and requirements for harmonic control in electrical power systems
IEEE Std 1453™	IEEE recommended practice for the analysis of fluctuating installations on power systems
IEEE Std 1815™	IEEE standard for electric power systems communications-distributed network protocol (DNP3)
ANSI C84.1	Electric power systems and equipment — Voltage ratings (60 Hz)

Important Notices and Disclaimers Concerning IEEE Standards Documents

IEEE documents are made available for use subject to important notices and legal disclaimers. These notices and disclaimers, or a reference to this page, appear in all standards and may be found under the heading “Important Notices and Disclaimers Concerning IEEE Standards Documents.” They can also be obtained on request from IEEE or viewed at <http://standards.ieee.org/IPR/disclaimers.html>.

Notice and Disclaimer of Liability Concerning the Use of IEEE Standards Documents

IEEE Standards documents (standards, recommended practices, and guides), both full-use and trial-use, are developed within IEEE Societies and the Standards Coordinating Committees of the IEEE Standards Association (“IEEE-SA”) Standards Board. IEEE (“the Institute”) develops its standards through a consensus development process, approved by the American National Standards Institute (“ANSI”), which brings together volunteers representing varied viewpoints and interests to achieve the final product. IEEE Standards are documents developed through scientific, academic, and industry-based technical working groups. Volunteers in IEEE working groups are not necessarily members of the Institute and participate without compensation from IEEE. While IEEE administers the process and establishes rules to promote fairness in the consensus development process, IEEE does not independently evaluate, test, or verify the accuracy of any of the information or the soundness of any judgments contained in its standards.

IEEE Standards do not guarantee or ensure safety, security, health, or environmental protection, or ensure against interference with or from other devices or networks. Implementers and users of IEEE Standards documents are responsible for determining and complying with all appropriate safety, security, environmental, health, and interference protection practices and all applicable laws and regulations.

IEEE does not warrant or represent the accuracy or content of the material contained in its standards, and expressly disclaims all warranties (express, implied and statutory) not included in this or any other document relating to the standard, including, but not limited to, the warranties of: merchantability; fitness for a particular purpose; non-infringement; and quality, accuracy, effectiveness, currency, or completeness of material. In addition, IEEE disclaims any and all conditions relating to: results; and workmanlike effort. IEEE standards documents are supplied “AS IS” and “WITH ALL FAULTS.”

Use of an IEEE standard is wholly voluntary. The existence of an IEEE standard does not imply that there are no other ways to produce, test, measure, purchase, market, or provide other goods and services related to the scope of the IEEE standard. Furthermore, the viewpoint expressed at the time a standard is approved and issued is subject to change brought about through developments in the state of the art and comments received from users of the standard.

In publishing and making its standards available, IEEE is not suggesting or rendering professional or other services for, or on behalf of, any person or entity nor is IEEE undertaking to perform any duty owed by any other person or entity to another. Any person utilizing any IEEE Standards document, should rely upon his or her own independent judgment in the exercise of reasonable care in any given circumstances or, as appropriate, seek the advice of a competent professional in determining the appropriateness of a given IEEE standard.

IN NO EVENT SHALL IEEE BE LIABLE FOR ANY DIRECT, INDIRECT, INCIDENTAL, SPECIAL, EXEMPLARY, OR CONSEQUENTIAL DAMAGES (INCLUDING, BUT NOT LIMITED TO: PROCUREMENT OF SUBSTITUTE GOODS OR SERVICES; LOSS OF USE, DATA, OR PROFITS; OR BUSINESS INTERRUPTION) HOWEVER CAUSED AND ON ANY THEORY OF LIABILITY, WHETHER IN CONTRACT, STRICT LIABILITY, OR TORT (INCLUDING NEGLIGENCE OR OTHERWISE) ARISING IN ANY WAY OUT OF THE PUBLICATION, USE OF, OR RELIANCE UPON ANY STANDARD, EVEN IF ADVISED OF THE POSSIBILITY OF SUCH DAMAGE AND REGARDLESS OF WHETHER SUCH DAMAGE WAS FORESEEABLE.

Translations

The IEEE consensus development process involves the review of documents in English only. In the event that an IEEE standard is translated, only the English version published by IEEE should be considered the approved IEEE standard.

Official statements

A statement, written or oral, that is not processed in accordance with the IEEE-SA Standards Board Operations Manual shall not be considered or inferred to be the official position of IEEE or any of its committees and shall not be considered to be, or be relied upon as, a formal position of IEEE. At lectures, symposia, seminars, or educational courses, an individual presenting information on IEEE standards shall make it clear that his or her views should be considered the personal views of that individual rather than the formal position of IEEE.

Comments on standards

Comments for revision of IEEE Standards documents are welcome from any interested party, regardless of membership affiliation with IEEE. However, IEEE does not provide consulting information or advice pertaining to IEEE Standards documents. Suggestions for changes in documents should be in the form of a proposed change of text, together with appropriate supporting comments. Since IEEE standards represent a consensus of concerned interests, it is important that any responses to comments and questions also receive the concurrence of a balance of interests. For this reason, IEEE and the members of its societies and Standards Coordinating Committees are not able to provide an instant response to comments or questions except in those cases where the matter has previously been addressed. For the same reason, IEEE does not respond to interpretation requests. Any person who would like to participate in revisions to an IEEE standard is welcome to join the relevant IEEE working group.

Comments on standards should be submitted to the following address:

Secretary, IEEE-SA Standards Board
445 Hoes Lane
Piscataway, NJ 08854 USA

Laws and regulations

Users of IEEE Standards documents should consult all applicable laws and regulations. Compliance with the provisions of any IEEE Standards document does not imply compliance to any applicable regulatory requirements. Implementers of the standard are responsible for observing or referring to the applicable regulatory requirements. IEEE does not, by the publication of its standards, intend to urge action that is not in compliance with applicable laws, and these documents may not be construed as doing so.

Copyrights

IEEE draft and approved standards are copyrighted by IEEE under U.S. and international copyright laws. They are made available by IEEE and are adopted for a wide variety of both public and private uses. These include both use, by reference, in laws and regulations, and use in private self-regulation, standardization, and the promotion of engineering practices and methods. By making these documents available for use and adoption by public authorities and private users, IEEE does not waive any rights in copyright to the documents.

Photocopies

Subject to payment of the appropriate fee, IEEE will grant users a limited, non-exclusive license to photocopy portions of any individual standard for company or organizational internal use or individual, non-commercial use only. To arrange for payment of licensing fees, please contact Copyright Clearance Center, Customer Service, 222 Rosewood Drive, Danvers, MA 01923 USA; +1 978 750 8400. Permission to photocopy portions of any individual standard for educational classroom use can also be obtained through the Copyright Clearance Center.

Updating of IEEE Standards documents

Users of IEEE Standards documents should be aware that these documents may be superseded at any time by the issuance of new editions or may be amended from time to time through the issuance of amendments, corrigenda, or errata. An official IEEE document at any point in time consists of the current edition of the document together with any amendments, corrigenda, or errata then in effect.

Every IEEE standard is subjected to review at least every ten years. When a document is more than ten years old and has not undergone a revision process, it is reasonable to conclude that its contents, although still of some value, do not wholly reflect the present state of the art. Users are cautioned to check to determine that they have the latest edition of any IEEE standard.

In order to determine whether a given document is the current edition and whether it has been amended through the issuance of amendments, corrigenda, or errata, visit the IEEE-SA Website at <https://ieeexplore.ieee.org/> or contact IEEE at the address listed previously. For more information about the IEEE-SA or IEEE's standards development process, visit the IEEE-SA Website at <http://standards.ieee.org>.

Errata

Errata, if any, for all IEEE standards can be accessed on the IEEE-SA Website at the following URL: <http://standards.ieee.org/findstds/errata/index.html>. Users are encouraged to check this URL for errata periodically.

Patents

Attention is called to the possibility that implementation of this standard may require use of subject matter covered by patent rights. By publication of this standard, no position is taken by the IEEE with respect to the existence or validity of any patent rights in connection therewith. If a patent holder or patent applicant has filed a statement of assurance via an Accepted Letter of Assurance, then the statement is listed on the IEEE-SA Website at <http://standards.ieee.org/about/sasb/patcom/patents.html>. Letters of Assurance may indicate whether the Submitter is willing or unwilling to grant licenses under patent rights without compensation or under reasonable rates, with reasonable terms and conditions that are demonstrably free of any unfair discrimination to applicants desiring to obtain such licenses.

Essential Patent Claims may exist for which a Letter of Assurance has not been received. The IEEE is not responsible for identifying Essential Patent Claims for which a license may be required, for conducting inquiries into the legal validity or scope of Patents Claims, or determining whether any licensing terms or conditions provided in connection with submission of a Letter of Assurance, if any, or in any licensing agreements are reasonable or non-discriminatory. Users of this standard are expressly advised that determination of the validity of any patent rights, and the risk of infringement of such rights, is entirely their own responsibility. Further information may be obtained from the IEEE Standards Association.

Acknowledgements

During the writing of this standard, one of our Working Group members, Keith Harley, passed away. Keith had an enthusiasm and passion for his career and for his family. He made a positive impact on those he worked with and made the travel more interesting and fun with his adventurous personality and stories about travel. Keith had a unique ability to articulate very complex technical issues into language that is clear and meaningful. On several occasions, his leadership contributed to establishing some major milestones in this standard and for other IEEE standards development for North America. We are saddened by his loss. His contributions to the industry have been important and will be long-lasting.

Participants

At the time this standard was completed, the Standards Coordinating Committee 21 on Fuel Cells, Photovoltaics, Dispersed Generation, and Energy Storage had the following membership:

Mark Siira, Chair
Babak Enayati, Vice Chair
Jens C. Boemer, Secretary
Charles K. Vartanian, Treasurer

Thomas (Tom) Basso
Leo Casey
Sudipta Chakraborty
Fei Gao
Frank Goodman
Bob Heile
Anderson Hoke

Victor Huang
Ben Kazimier
Joseph L. Koepfinger
Ben Kroposki
Debra Lew
Wenpeng Luan
David J. Narang
Adel Nasiri

Michael Ropp
Robert Saint
Chris Searles
Robby Simpson
Wayne Stec
Reigh Walling
Timothy Zgonena

At the time this standard was completed, the Interconnection and Interoperability of Distributed Energy Resources with Associated Electric Power Systems Interfaces Working Group (P1547 WG) of the Standard Coordinating Committee 21 (SCC21) on Fuel Cells, Photovoltaics, Dispersed Generation, and Energy Storage had the following membership:

David J. Narang, Chair
Thomas (Tom) Basso, Past Chair
John Berdner, Jens C. Boemer, Babak Enayati, Bob Fox, Mark Siira, Vice Chairs
Charles K. Vartanian, Secretary

Facilitators

Jeannie M. Amber-Piekarz, Richard Bravo, Leo Casey, Frances Cleveland, Michael (Mike) Coddington, Dan Mungovan, Mohammad (Aminul) Huque, Marty Page, Michael (Mike) Ropp, Chris Rowe, Brian Seal, Wayne Stec, Reigh Walling

Marcelo Algrain
Steven Allmond
Daniel Arjona
Dillon Ashton
Manuel Avendano
George Berntsen
David Blackledge
Jason Bobruk
Michael Brigandi
Edwin Briggs

Paul Brucke
Ken Brunkenhoefer
Jason Byerly
Sean Carr
James Carroll
Sudipta Chakraborty
Ke Chen
Nancy Connelly
Adam Cordova
Robert Cummings

James Daley
Patrick Dalton
Herbert Daugherty
Dick DeBlasio
Mamadou Diongt
Stanley Doe
Paul Dolloff
Anthony Eason
Jonathan Ehlmann
Zakia El Omari

Bryan Espiritu
Wesley Fassnacht
Roberto Favela
Terry Fix
David Forrest
Masuda Fumio
Darrell Furlong
John Gajda
Halie Gashaw
Ken Gebauer
Sigifredo Gonzalez
Tilak Gopalarathnam
Jason Gunawardena
Thomas Gwinn
Joshua Hambrick
Keith Harley
Robert Harris
Allen Heffner
Paul Heitmann
Anderson Hoke
Soonwook Hong
Fred Horton
Keith Houser
James Hurtt
Ruben Inzunza
Hiroshi Iirie
Bob Jordan
Prashant Kansal

Scott Karpel
Ben Kazimier
Gregory Kern
John Kotula
Paul Krell
Kandice Kubojiri
Jesse Leonard
Eddy Lim
Howard Liu
Brian Lydic
Bruce Magruder
Fumio Masuda
Barry Mather
Alex Mayer
Jonathan Meyer
Lyman Morikawa
Naga Mosam
John Moura
Rohit Nair
Amir Najafzadeh
Eithar Nashawati
Jeffrey Newmiller
Catherine O'Brien
Justin Odom
Vishal Patel
Prasad Pmsvsv
Robert Preus

James Reilly
Denisse Rivera
Roe Rodrigo
John Ruddock
Nachum Sadan
Roger Salas
Janette Sandberg
Joseph Schaefer
Karl Schoder
Ulrich Schwabe
Rich Scroggins
Robert Sherman
Ronald Shipman
Jaspreet Singh
Mark Smith
Gary Smullin
Jim Sprecher
Clayton Stice
Chase Sun
Monica Taba
Sylvester Toe
Phillip Undercuffler
Rajiv Varma
Robert White
Stephen Yee
Li Yu
Mehran Zamani
Tim Zgonena

The following working group members participated in finalizing the development of the standard with working group inputs, and in facilitating the development of those inputs development process:

Marcelo Algrain
Jeannie M. Amber-Pickarz
John Berdner
Jens C. Boemer
Richard Bravo
Leo Casey
Frances Cleveland
Michael Coddington
Nancy Connelly
Babak Enayati

Bob Fox
Robert Harris
Anderson Hoke
Aminul Huque
Greg Kern
Paul Krell
Dan Mungovan
David J. Narang
Marty Page
Michael Ropp

Brian Seal
Ronald Shipman
Mark Siira
Mark Smith
Wayne Stec
Clayton Stice
Chase Sun
Charles K. Vartanian
Reigh Walling

The following members of the individual balloting committee voted on this standard. Balloters may have voted for approval, disapproval, or abstention.

Mahamadou Abdou Tankari
William Ackerman
Kennedy Aganah
Mark Ahlstrom
Ali Al Awazi
Mihaela Albu
Saleman Alibhay
Eric Allen
Steven Allmond
Jeannie M. Amber-Pickarz
Jay Anderson
Daniel Arjona
Curtis Ashton
Carlos Avalos

Mark Baldassari
Abdallah Barakat
John Baranowski
Thomas Barnes
Paul Barnhart
Jeffrey Barsch
Frank Basciano
Michael Basler
David Bassett
Thomas (Tom) Basso
David Beach
John Berdner
George Berntsen
Martin Best

Murty Bhavaraju
Wallace Binder
Richard Bingham
Thomas Blackburn
William Bloethe
Jens Boemer
Shelly Born
Ward Bower
Brian Boysen
Clarence Bradley
Matthew Braet
Richard Bravo
Edwin Briggs
Adam Bromley

David Brown
Paul Brucke
Gustavo Brunello
Ken Brunkenhoefer
Demetrio Jr Bucaneg
Clayton Burns
Jeffrey Burnworth
William Bush
Jason Byerly
William Byrd
Jose Cano Rodriguez
Paul Cardinal
Clint Carne
Sean Carr
Juan Carreon
James Carroll
Leo Casey
Sudipta Chakraborty
Wen-Kung Chang
Nancy Chilton
Michael Chirico
James Cleary
Frances Cleveland
Michael Coddington
Gregg Cohn
Nancy Connelly
Larry Conrad
Stephen Conrad
Terry Conrad
Adam Cordova
Luis Coronado
Randall Crellin
Frederick Crofut
Timothy Croushore
Curtis Cryer
Robert Cummings
James Daley
Patrick Dalton
Ratan Das
Herbert Daugherty
Kent Davenport
Matthew Davis
David E. De Luca
Robert Dempsey
Mamadou Diong
Dieter Dohnal
Gary Donner
Michael Dood
Neal Dowling
Michael Doyle
Herbert Dreyer
David Dunne
Anthony Eason
Paul Eaton
Aaron Ellis
Zakia El Omari
Babak Enayati
Brian Escott
David Farmer
Jorge Fernandez Daher
Curtis Fischer
Terry Fix

Rostyslaw Fostiak
Robert Fox
Jerry Franklin
Dale Fredrickson
John Gajda
Hailegebriel Gashaw
Ken Gebauer
Thomas Gentile
David Gilmer
Mietek Glinkowski
Tim Godfrey
Jalal Gohari
Philip Gonski
Tilak Gopalarathnam
J. T. Gordon
James Graham
Joseph Grappe
Stephen Grier
Randall Groves
Donald Hall
Joshua Hambrick
John Harley
Robert Harris
Steven Hensley
Rodrigo Hidalgo
Todd Hiemer
Michael Higginson
Werner Hoelzl
Robert Hoerauf
Martin Hohl
Anderson Hoke
Dennis Holstein
Soonwook Hong
Lawrence Hopkins
Philip Hopkinson
John Houdek
Keith Houser
Edward Hoy
Pao-Hsiang Hsi
Mohammad Huque
James Hurtt
Noriyuki Ikeuchi
David Ingram
Dmitry Ishchenko
Richard Jackson
Lu Jiang
Anthony Johnson
Gerald Johnson
Geza Joos
Mark Jurgemeyer
Gunnar Kaestle
Prashant Kansal
Scott karpel
Robert Kazimier
Peter Kelly
Leon Kempner
Chad Kennedy
Gregory Kern
Yuri Khersonsky
Amin Khodaei
James Kinney
Chad Knutson

Troy Knutson
Boris Kogan
Ljubomir Kojovic
Paul Krell
Jim Kulchisky
Larry Lackey
Marc Lacroix
Mikhail Lagoda
Chung-Yiu Lam
Raluca Lascu
Theo Laughner
James Lee
Wei-Jen Lee
Andrew Levitt
Debra Lew
Erik Limpaecher
Haiwen Liu
Brian Lydic
Bruce Mackie
Reginaldo Maniego
Robert Manning
Barry Mather
Omar Mazzoni
William McBride
Michael McCarty
John Mcdaniel
Thomas McDermott
John McDonald
Jeffrey Mcelray
Hank McGlynn
Sean Mcguinness
Michael Mcinerney
Brian McMillan
Jonathan Meyer
Bob Micek
C. Michael Miller
James Mirabile
Jeffery Mizener
Daleep Mohla
Charles Mozina
Daniel Mungovan
Jerry Murphy
R. Murphy
Mark Murray
Bruce Muschlitz
Pratap Mysore
K. R. M. Nair
Rohit Nair
Arun Narang
David J. Narang
Alexandre Nassif
Russell Neal
John Nelson
Robert Nelson
Ernest Neubauer
Michael Newman
Jeffrey Newmiller
Ryan Niemerg
James Niemira
Joe Nims
Matthew Norwalk
James O'Brien

T. W. Olsen
Gregory Olson
Lorraine Padden
Marty Page
Jonathan Palmer
Bansi Patel
Marc Patterson
Stephen Pell
Mateusz Pena
Robert Pettigrew
Dean Philips
Anthony Picagli
Bruce Pickett
Prasad Pmsvsv
Iulian Profir
Brian Purvis
Khalid Rahman
Farnoosh Rahmatian
James Reilly
Kenneth Rempe
Charles Rogers
Benjamin Rolfe
Michael Ropp
James Rossman
Thomas Rozek
Daniel Sabin
Chester Sandberg
Janette Sandberg
Steven Sano
Sergio Santos
Surya Santoso
Vincent Saporita
Bartien Sayogo
Robert Schaerer
Karl Schoder

Jeffrey Schoenecker
Matthew Schuerger
Robert Schuerger
Robert Schultz
Rebecca Schulz
Brian Seal
Christopher Searles
Kenneth Sedziol
Robert Seitz
John Seuss
Nikunj Shah
Harish Sharma
Ronald Shipman
Mark Siira
Hyeong Sim
David Smith
James Smith
Jeremy Smith
Jerry Smith
Mark Smith
Gary Smullin
Joseph Sowell
Lincoln Sprague
James Sprecher
Joseph Stanco
Ryan Stargel
Wayne Stec
Marcus Steel
Michael Stelts
Michael Stephens
Clayton Stice
Allan St Peter
K. Stump
Chase Sun
Sercan Teleke

David Tepen
Michael Thesing
Casey Thomas
Sylvester Toe
James Tomaseski
Maria Tome
Richard Tressler
Francois Trichon
Craig Turner
Philip Undercuffler
Timothy Unruh
James van de Ligt
Benton Vandiver
Luis Vargas
Charles K. Vartanian
Eric Vaughn
S. Venkata
John Vergis
Sarah Walinga
Simon Wall
Reigh Walling
John Wang
Daniel Ward
Keith Waters
John Webb
Kenneth White
Robert White
Allen Windhorn
Philip Winston
Justin Woodard
Ben York
Jennifer Yu
Oren Yuen
Nicholas Zagrodnik
David Zech

When the IEEE-SA Standards Board approved this standard on 15 February 2018, it had the following membership:

Jean-Philippe Faure, *Chair*
Vacant Position, *Vice Chair*
John D. Kulick, *Past Chair*
Konstantinos Karachalios, *Secretary*

Ted Burse
Guido R. Hiertz
Gary Hoffman
Christel Hunter
Joseph L. Koepfinger*
Thomas Koshy
Hung Ling

Dong Liu
Xiaohui Liu
Kevin Lu
Daleep Mohla
Andrew Myles
Paul Nikolich
Ronald C. Petersen
Annette D. Reilly

Robby Robson
Dorothy Stanley
Mehmet Ulema
Phil Wennblom
Philip Winston
Howard Wolfman
Jingyi Zhou

*Member Emeritus

Contents

1. Overview	15
1.1 General	15
1.2 Scope	15
1.3 Purpose	16
1.4 General remarks and limitations	16
1.5 Conventions for word usage and notes to text, tables and figures	20
2. Normative references.....	20
3. Definitions and acronyms.....	21
3.1 Definitions	21
3.2 Acronyms	26
4. General interconnection technical specifications and performance requirements	27
4.1 Introduction	27
4.2 Reference points of applicability (RPA).....	28
4.3 Applicable voltages	29
4.4 Measurement accuracy	30
4.5 Cease to energize performance requirement.....	31
4.6 Control capability requirements.....	31
4.7 Prioritization of DER responses	32
4.8 Isolation device.....	33
4.9 Inadvertent energization of the Area EPS.....	33
4.10 Enter service	33
4.11 Interconnect integrity.....	35
4.12 Integration with Area EPS grounding.....	35
4.13 Exemptions for emergency systems and standby DER	35
5. Reactive power capability and voltage/power control requirements	36
5.1 Introduction	36
5.2 Reactive power capability of the DER	37
5.3 Voltage and reactive power control.....	38
5.4 Voltage and active power control	41
6. Response to Area EPS abnormal conditions.....	42
6.1 Introduction	42
6.2 Area EPS faults and open phase conditions.....	43
6.3 Area EPS reclosing coordination.....	43
6.4 Voltage	44
6.5 Frequency	54
6.6 Return to service after trip	60
7. Power quality.....	61
7.1 Limitation of dc injection	61
7.2 Limitation of voltage fluctuations induced by the DER	61
7.3 Limitation of current distortion.....	62
7.4 Limitation of overvoltage contribution.....	63
8. Islanding.....	65
8.1 Unintentional islanding.....	65
8.2 Intentional islanding	65

9. DER on distribution secondary grid/area/street (grid) networks and spot networks	67
9.1 Network protectors and automatic transfer scheme requirements	67
9.2 Distribution secondary grid networks.....	68
9.3 Distribution secondary spot networks.....	68
10. Interoperability, information exchange, information models, and protocols.....	69
10.1 Interoperability requirements.....	69
10.2 Monitoring, control, and information exchange requirements.....	69
10.3 Nameplate information	69
10.4 Configuration information	70
10.5 Monitoring information	70
10.6 Management information.....	71
10.7 Communication protocol requirements.....	75
10.8 Communication performance requirements.....	75
10.9 Cyber security requirements	76
11. Test and verification requirements	76
11.1 Introduction	76
11.2 Definition of test and verification methods	77
11.3 Full and partial conformance testing and verification	79
11.4 Fault current characterization	94
Annex A (informative) Bibliography	95
Annex B (informative) Guidelines for DER performance category assignment	98
B.1 Introduction.....	98
B.2 Background.....	98
B.3 Normal and abnormal performance category standard approach.....	99
B.4 Performance category assignment.....	102
Annex C (informative) DER intentional and microgrid island system configurations.....	107
C.1 Introduction.....	107
C.2 Connecting DER not designed for intentional island or microgrid operation.....	108
Annex D (informative) DER communication and information concepts and guidelines	109
D.1 Introduction	109
D.2 General principles.....	109
D.3 Communication protocols.....	111
D.4 Cyber security.....	111
D.5 Related standards	113
Annex E (informative) Basis for ride-through of consecutive voltage disturbances.....	115
E.1 Introduction.....	115
E.2 Faults, fault protection, and reclosing	115
E.3 Unrelated faults	120
E.4 Intermittent faults.....	120
E.5 Voltage oscillations.....	120
Annex F (informative) Discussion of testing and verification requirements at PCC or PoC	121
Annex G (informative) Power quality (PQ) clause concepts and guidelines.....	123
G.1 Introduction	123
G.2 Rapid voltage change (RVC) limits.....	123
G.3 Flicker limits.....	125
G.4 Current distortion limits.....	126

G.5 Limitation of overvoltage	128
G.6 Related standards	128
Annex H (informative) Figures illustrating general interconnection technical specifications and performance requirements of Clause 4 to Clause 6	129
H.1 Informative figures related to 4.2 [Reference points of applicability (RPA)].....	129
H.2 Informative figures related to Clause 5 (Reactive power capability and voltage/power control requirements).....	130
H.3 Informative figures related to Clause 6 (Response to Area EPS abnormal conditions).....	133

Indian Standard

INTERCONNECTION AND INTEROPERABILITY OF
DISTRIBUTED ENERGY RESOURCES WITH
ASSOCIATED ELECTRIC POWER
SYSTEMS INTERFACES

1. Overview

1.1 General

This standard provides interconnection and interoperability technical and test specifications and requirements for distributed energy resources (DERs). Additionally, several annexes are included in this standard that provide additional material for informative purposes, but are not required to be used in conjunction with this standard.

1.2 Scope

This standard establishes criteria and requirements for interconnection of distributed energy resources with electric power systems (EPSs) and associated interfaces. The stated technical specifications and requirements are universally needed for interconnection and interoperability of distributed energy resources (DERs)² and will be sufficient for most installations.³ The specified performance requirements apply at the time of interconnection and as long as the DER remains in service.

²For example, synchronous machines, induction machines, or static power inverters/converters.

³Additional technical requirements may be necessary for higher DER penetration situations.

1.3 Purpose

This document provides a uniform standard for the interconnection and interoperability of distributed energy resources with electric power systems. It provides requirements relevant to the interconnection and interoperability performance, operation and testing, and, to safety, maintenance and security considerations.

1.4 General remarks and limitations

The criteria and requirements in this document are applicable to all distributed energy resource technologies interconnected to EPSs at typical primary or secondary distribution voltage levels. Installation of DER on radial primary and secondary distribution systems is the main emphasis of this standard, although installation of DER on primary and secondary network distribution systems is considered. This standard has been written assuming a 60 Hz nominal system frequency.⁴

Figure 1 illustrates the scope of this standard. The criteria and requirements in this document may influence the design and capabilities of the power interface, the *local DER communication interface* and all those parts of a DER that are related to meeting the requirements of this standard. In Clause 4 to Clause 11, the term “DER” refers to all those parts of a DER that are related to meeting the interconnection and interoperability requirements of this standard.

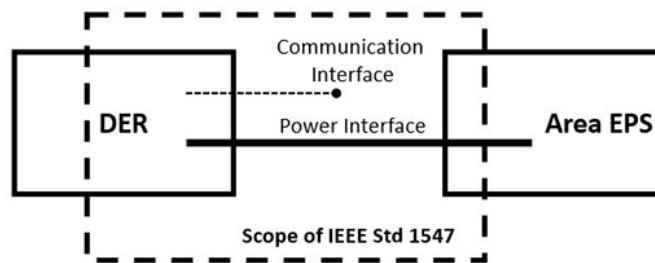

Figure 1 —Scope of this standard

The following list describes what remains outside the scope of this standard:

- This standard as a whole is not intended for, and is in part inappropriate for, application to energy resources connected to transmission or networked sub-transmission systems.^{5, 6}
- This standard does not define the maximum DER capacity for a particular installation that may be interconnected to a single point of common coupling (PCC) or connected to a given feeder.
- Outside of the specific interconnection and interoperability requirements in the following clauses, this standard does not prescribe DER self-protection or any DER operating requirements, as long as these do not preclude the DER from meeting the requirements of this standard.⁷
- This standard does not address planning, designing, operating, or maintaining the Area EPS with DER.

⁴If the standard is used with other nominal frequency values, all frequency values in the standard should be adjusted appropriately. This may require proportional adjustment of the frequency values in coordination with the *regional reliability coordinator*.

⁵Investigations of events that inadvertently tripped *bulk power system* connected resources in North America suggest that one root cause may have been misapplication of previous versions of this standard; refer to NERC [B28] for more details.

⁶The performance of energy resources connected to transmission or networked sub-transmission systems may be specified by the responsible transmission planner in coordination with the *regional reliability coordinator*.

⁷Requirements specified in 6.4.2 and 6.5.2 do provide constraints that must be respected in the application of DER self-protection.

- This standard does not apply to automatic transfer schemes in which load is transferred between the DER and the EPS in a momentary make-before-break operation provided the duration of paralleling the sources is less than 100 ms, except as noted in [Clause 9](#).
- As defined in [4.13](#), [5.3.1](#), [6.4.2.1](#), [6.5.2.1](#), and [10.1](#), emergency and standby DER⁸ are exempt from certain requirements of this standard.
- This standard does not give any guidance regarding how the Area EPS operator may specify functional parameter settings other than the default setting within the specified *ranges of allowable settings*, e.g., to coordinate with the existing Area EPS protection and control devices.
- This standard does not determine the communication network specifics nor the utilization of the DER provisions for a local DER interface capable of communicating (*local DER communication interface*) to support the information exchange requirements specified in this standard.
- The lower and upper values of the *ranges of allowable settings* for voltage and frequency trip settings specified in this standard for DER are not intended to limit the capabilities and settings of other equipment on the Area EPS.⁹
- For DER interconnections that include individual synchronous generator units rated 10 MVA and greater, and where the requirements of this standard conflict with the requirements of IEEE Std C50.12 or IEEE Std C50.13, the requirements of IEEE Std C50.12 or IEEE Std C50.13, as relevant to the type of synchronous generator used, shall prevail.

This standard applies to interconnection based on the aggregate nameplate rating of all the DER units that are within the Local EPS. Supplemental DER devices other than DER units may be used to achieve compliance with the requirements of this standard at the applicable reference point per [Clause 4](#). These devices are not required to be co-located with the DER units, but shall be within the Local EPS. The requirements of this standard shall be met regardless of the location of the DER and supplemental DER devices within the Local EPS. These relationships are shown in [Figure 2](#).

⁸As defined by authority having jurisdiction.

⁹Refer to footnotes [80](#) and [99](#) on recommendations for utility practices to use trip settings on Area EPS equipment that conflict with this standard to occasionally and selectively accommodate worker safety practices or to safeguard distribution infrastructure while in an abnormal configuration.

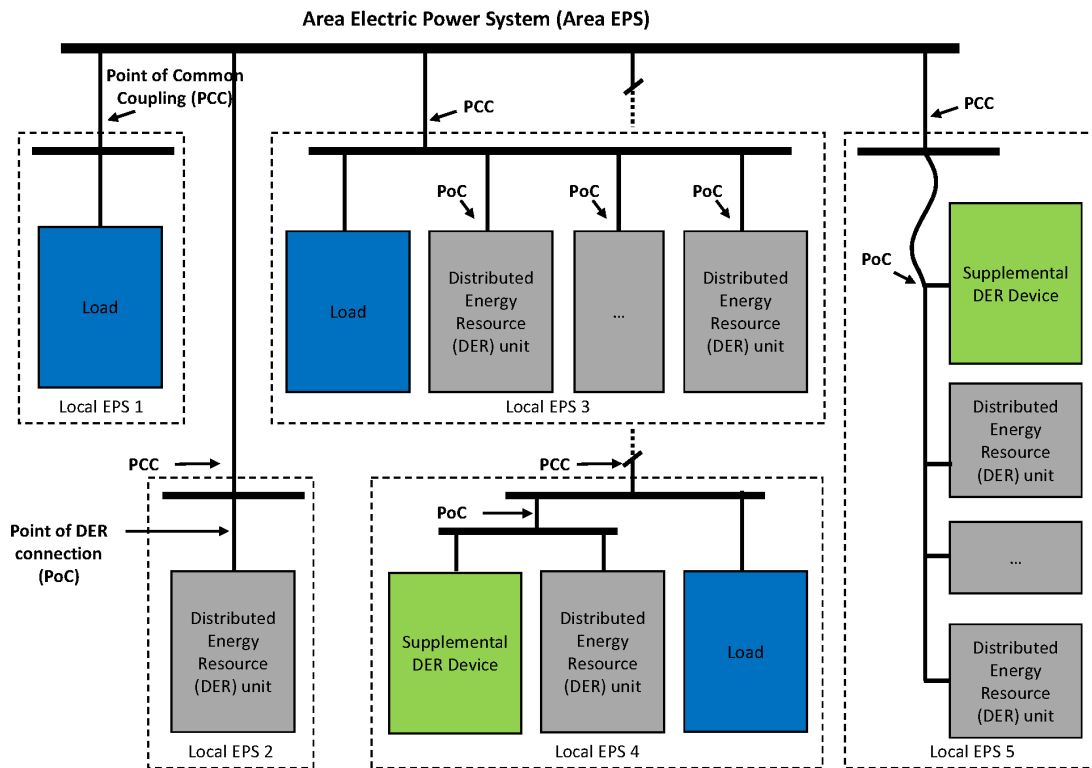

NOTE 1—The example of Local EPS 1 includes only load. Any requirements for this Local EPS are outside the scope of this standard.

NOTE 2—The example of Local EPS 2 includes only DER. Depending on the DER rating, requirements of this standard apply either at the PCC or the PoC. The DER unit in this example is able to meet requirements at its terminals without any supplemental DER device; the PoC coincides with the DER unit's terminals.

NOTE 3—The example of Local EPS 3 includes both DER units and load. Depending on the aggregate DER units' rating and the percent of average load demand, requirements of this standard apply either at the PCC or the PoC. The two (or more) DER units are able to meet requirements at its terminals without any supplemental DER device; the PoC coincides with the DER units' terminals; there are two (or more) PoCs.

NOTE 4—The example of Local EPS 4 includes a DER unit, a supplemental DER device, and load. Depending on the DER unit's rating and the percent of average load demand, requirements of this standard apply either at the PCC or the PoC. The DER unit is not able to meet requirements at its terminals without any supplemental DER device; the PoC is the point where the requirements of this standard are met by the DER unit in conjunction with the supplemental DER device exclusive of any load, if present, in the respective part of the Local EPS.

NOTE 5—The example of Local EPS 5 includes two (or more) DER units and a supplemental DER device but no load. Depending on the aggregate DER units' rating, requirements of this standard apply either at the PCC or the PoC. As indicated by the curved line, the PCC and PoC may be located well apart from each other. The two (or more) DER units are not able to meet requirements at their terminals without any supplemental DER device; the PoC is the point where the requirements of this standard are met by two (or more) DER units in conjunction with the supplemental DER device exclusive of any load, if present, in the respective part of the Local EPS.

Figure 2 —Relationship of interconnection terms

The stated technical specifications and requirements are universally needed for interconnection and interoperability of DER¹⁰ and will be sufficient for most installations.¹¹ The applicability of certain specifications and requirements are dependent on application considerations. For these, the requirements are provided in terms of a limited number of technology-neutral performance categories, for which it is the responsibility of the *authority governing interconnection requirements* (AGIR) to determine applicability. The rationale used as the basis for the performance categories is as follows:

For categories related to reactive power capability and voltage regulation performance requirements (Clause 5):

- Category A covers minimum performance capabilities needed for Area EPS voltage regulation and are reasonably attainable by all DER technologies as of the publication of this standard. This level of performance is deemed adequate for applications where the DER penetration in the distribution system is lower,¹² and where the overall DER power output is not subject to frequent large variations.
- Category B covers all requirements within Category A and specifies supplemental capabilities needed to adequately integrate DERs in local Area EPSs where the aggregated DER penetration is higher or where the overall DER power output is subject to frequent large variations.

For categories related to response to Area EPS abnormal conditions (Clause 6):

- *Abnormal operating performance Category I* is based on essential *bulk power system* (BPS) stability/reliability needs and reasonably attainable by all DER technologies that are in common usage today.
- *Abnormal operating performance Category II* covers all BPS stability/reliability needs and is coordinated with existing reliability standards¹³ to avoid tripping for a wider range of disturbances of concern to BPS stability.¹⁴
- *Abnormal operating performance Category III* is based on both BPS stability/reliability and distribution system reliability/power quality needs and is coordinated with existing interconnection requirements for very high DER penetration.¹⁵

All performance categories specify minimum equipment capability requirements and may also specify designated limiting requirements for *ranges of allowable settings* of control or trip parameter values. For categories related to reactive power capability and voltage regulation performance requirements (Clause 5), Category B is inherently capable of meeting the requirements for Category A. For categories related to response to Area EPS abnormal conditions (Clause 6), categories with higher number values are inherently capable of meeting the voltage and frequency ride-through requirements of lower number value categories; however, this may not hold for voltage and frequency trip requirements because their *ranges of allowable settings* may be mutually exclusive. If a DER listed for a higher level *abnormal operating performance category* was used in a lower-level category application, the correct *range of allowable settings* for magnitude and duration values of trip settings shall be ensured, for example by the use of software profiles designated for each *abnormal operating performance category*.

¹⁰For example, synchronous machines, induction machines, or static power inverters/converters.

¹¹Additional technical requirements may be necessary for some limited situations.

¹²This clause intentionally uses qualitative DER penetration levels qualifiers. The impact of DER on frequency and voltage performance of the interconnections and the regional power systems differs significantly and it remains in the responsibility of an AGIR to quantify impactful DER penetration levels. Refer to Annex B for more rationale on category assignments.

¹³In North America, the limitations for transmission-connected resources as specified in NERC PRC-024-2 [B27] may be used for reference.

¹⁴Includes 1LG stuck breaker transmission faults as well as normally and delayed cleared faults at the lower-level transmission and sub-transmission levels where fault durations can be longer (primarily due to the use of zone impedance relaying), e.g., sub-transmission 3LG with normal fault clearing or simultaneous 1LG faults on different phases of two sub-transmission circuits on the same structure with normal fault clearing. (NERC [B26], [B28], [B29], [B30].)

¹⁵For example, CA Rule 21 [B4].

Additional guidelines on criteria for assignment of DER performance categories are given in [Annex B](#).¹⁶

Where applicable, the stated technical specifications and requirements are given in generator sign convention, which is opposite to load sign convention. In generator sign convention, a DER current lagging voltage provides/injects reactive power to the system (over-excited operation of DER, positive reactive power), and this tends to increase the applicable voltage under normal system conditions; a DER current leading voltage consumes/absorbs reactive power from the system (under-excited operation of DER, negative reactive power), and this tends to decrease of the applicable voltage under normal system conditions.

1.5 Conventions for word usage and notes to text, tables and figures

In this document, the word *shall* is used to indicate a mandatory requirement. The word *should* is used to indicate a recommendation. The word *may* is used to indicate a permissible action. The word *can* is used for statements of possibility and capability.

Notes to text, tables, and figures are for information only and do not contain requirements needed to implement the standard.

2. Normative references

The following referenced documents are indispensable for the application of this document (i.e., they shall be understood and used, so each referenced document is cited in text and its relationship to this document is explained). For dated references, only the edition cited applies. For undated references, the latest edition of the referenced document (including any amendments or corrigenda) applies.

ANSI C84.1, Electric Power Systems and Equipment—Voltage Ratings (60 Hz).¹⁷

IEC/TR 61000-3-7, Electromagnetic compatibility (EMC)—Part 3-7: Limits—Assessment of emission limits for the connection of fluctuating installations to MV, HV and EHV power systems.¹⁸

IEC 61000-4-3, Electromagnetic compatibility (EMC)—Part 4-3: Testing and measurement techniques—Radiated, radio-frequency, electromagnetic field immunity test.

IEC 61000-4-5, Electromagnetic compatibility (EMC)—Part 4-5: Testing and measurement techniques—Surge immunity test.

IEEE Std 519TM, IEEE Recommended Practices and Requirements for Harmonic Control in Electrical Power Systems.^{19, 20}

IEEE Std 1453TM, IEEE Recommended Practice for the Analysis of Fluctuating Installations on Power Systems.

IEEE Std 1815TM, IEEE Standard for Electric Power Systems Communications-Distributed Network Protocol (DNP3).

¹⁶As proposed in the IEEE P1547 response to FERC NOPR RM16-8 submitted by the IEEE Standards Association in May 2016 [B6], the criteria for assignment of DER performance categories outlined in the informative [Annex B](#) may be used as a reference point to partly specify “Good Utility Practice” for specific ride through requirements as required from small generating facilities per FERC Order 828 [B7].

¹⁷ANSI publications are available the American National Standards Institute (<http://www.ansi.org/>).

¹⁸IEC publications are available from the International Electrotechnical Commission (<http://www.iec.ch>) and the American National Standards Institute (<http://www.ansi.org/>).

¹⁹The IEEE standards or products referred to in [Clause 2](#) are trademarks owned by The Institute of Electrical and Electronics Engineers, Incorporated.

²⁰IEEE publications are available from The Institute of Electrical and Electronics Engineers (<http://standards.ieee.org/>).

IEEE Std 2030.5TM, IEEE Adoption of Smart Energy Profile 2.0 Application Protocol Standard.

IEEE Std C37.90.1TM, IEEE Standard Surge Withstand Capability (SWC) Tests for Relays and Relay Systems Associated with Electric Power Apparatus.

IEEE Std C37.90.2TM, IEEE Standard Withstand Capability of Relay Systems to Radiated Electromagnetic Interference from Transceivers.

IEEE Std C50.12TM, IEEE Standard for Salient-Pole 50 Hz and 60 Hz Synchronous Generators and Generator/Motors for Hydraulic Turbine Applications Rated 5 MVA and Above.

IEEE Std C50.13TM, IEEE Standard for Cylindrical-Rotor 50 Hz and 60 Hz Synchronous Generators Rated 10 MVA and Above.

IEEE Std C62.41.2TM, IEEE Recommended Practice on Characterization of Surges in Low Voltage (1000 V and less) AC Power Circuits.

IEEE Std C62.45TM, IEEE Recommended Practice on Surge Testing for Equipment Connected to Low-Voltage (1000 V and Less) AC Power Circuits.

IEEE Std C62.92.1TM, IEEE Guide for the Application of Neutral Grounding in Electric Utility Systems—Part I: Introduction.

3. Definitions and acronyms

For the purposes of this document, the following terms and definitions apply. The *IEEE Standards Dictionary Online* should be consulted for terms not defined in this document.²¹

NOTE—Defined terms and acronyms are italicized throughout the standard.²²

3.1 Definitions

abnormal operating performance category: The grouping for a set of requirements that specify technical capabilities and settings for a DER under abnormal operating conditions, i.e., outside the *continuous operation* region.

applicable voltage: Electrical quantities that determine the performance of a Local EPS or DER specified with regard to the *reference point of applicability*, individual phase-to-neutral, phase-to-ground, or phase-to-phase combination and time resolution.

NOTE—*Applicable voltages* are used as a synonym for *applicable frequency*, which can be derived from the *applicable voltages*.

area electric power system (Area EPS): An EPS that serves Local EPSs.

NOTE—Typically, an *Area EPS* has primary access to public rights-of-way, priority crossing of property boundaries, etc., and is subject to regulatory oversight. See [Figure 2](#).

area electric power system operator (Area EPS operator): The entity responsible for designing, building, operating, and maintaining the *Area EPS*.

²¹*IEEE Standards Dictionary Online* subscription is available at <http://dictionary.ieee.org>.

²²Notes in text, tables, and figures of a standard are given for information only and do not contain requirements needed to implement this standard.

authority governing interconnection requirements (AGIR): A cognizant and responsible entity that defines, codifies, communicates, administers, and enforces the policies and procedures for allowing electrical interconnection of DER to the *Area EPS*. This may be a regulatory agency, public utility commission, municipality, cooperative board of directors, etc. The degree of AGIR involvement will vary in scope of application and level of enforcement across jurisdictional boundaries. This authority may be delegated by the cognizant and responsible entity to the *Area EPS operator* or *bulk power system operator*.

NOTE—Decisions made by an authority governing interconnection requirements should consider various stakeholder interests, including but not limited to Load Customers, *Area EPS operators*, *DER operators*, and *bulk power system operator*.

authority having jurisdiction: Authority having the rights to inspection and approval of the design and construction of Local EPS premise electrical systems.

available active power: Active power that a DER can deliver to the *Area EPS* subject to the availability of the DER's primary source of energy.

NOTE—Examples are solar irradiance in the case of a photovoltaic DER and wind speed in case of a wind turbine generator.

bulk power system (BPS): Any electric generation resources, transmission lines, interconnections with neighboring systems, and associated equipment.

cease to energize: Cessation of active power delivery under steady-state and transient conditions and limitation of reactive power exchange.

NOTE 1—This may lead to momentary cessation or trip.

NOTE 2—This does not necessarily imply, nor exclude disconnection, isolation, or a trip.

NOTE 3—Limited reactive power exchange may continue as specified, e.g., through filter banks.

NOTE 4—Energy storage systems are allowed to continue charging but are allowed to cease from actively charging when the maximum state of charge (maximum stored energy) has been achieved.

NOTE 5—Refer to 4.5 for additional details.

clearing time: The time between the start of an abnormal condition and the DER ceasing to energize the *Area EPS*. It is the sum of the detection time, any adjustable time delay, the operating time plus arcing time for any interposing devices (if used), and the operating time plus arcing time for the interrupting device (used to interconnect the DER with the *Area EPS*).

continuous operation: Exchange of current between the DER and an EPS within prescribed behavior while connected to the *Area EPS* and while the *applicable voltage* and the system frequency is within specified parameters.

continuous operation region: The performance operating region corresponding to *continuous operation*.

distributed energy resource (DER): A source of electric power that is not directly connected to a bulk power system. DER includes both generators and energy storage technologies capable of exporting active power to an EPS. An interconnection system or a supplemental DER device that is necessary for compliance with this standard is part of a DER.²³

NOTE 1—Controllable loads used for demand response are not included in the definition of DER.

²³Equivalent to “distributed resources (DR)” as defined and used in IEEE Std 1547-2003.

NOTE 2—See [Figure 2](#).

distributed energy resource operator (DER operator): The entity responsible for operating and maintaining the distributed energy resource.

distributed energy resource (DER) unit: An individual DER device inside a group of DER that collectively form a system.

distributed energy resource managing entity (DER Managing Entity): An entity that monitors and manages the DER through the *local DER communication interface*. The DER managing entity could be for example a utility, an aggregator, a building energy management system, or other.

disturbance period: The range of time during which the *applicable voltage* or the system frequency is outside the *continuous operation region*.

electric power system (EPS): Facilities that deliver electric power to a load.

NOTE—This may include generation units. See [Figure 2](#).

energize: Active power outflow of the DER to an EPS under any conditions (e.g., steady state and transient).

enter service: Begin operation of the DER with an energized Area EPS.

flicker: The subjective impression of fluctuating luminance caused by voltage fluctuations.

NOTE—Above a certain threshold, flicker becomes annoying. The annoyance grows very rapidly with the amplitude of the fluctuation. At certain repetition rates even very small amplitudes can be annoying (IEEE Std 1453).

intentional island: A planned electrical island that is capable of being energized by one or more Local EPSs. These (1) have DER(s) and load, (2) have the ability to disconnect from and to parallel with the Area EPS, (3) include one or more Local EPS(s), and (4) are intentionally planned.

NOTE—An intentional island may be an *intentional Area EPS island* or an *intentional Local EPS island* (also: “facility island”).

intentional Area EPS island: An *intentional island* that includes portions of the Area EPS.

intentional Local EPS island: An intentional island that is totally within the bounds of a Local EPS.

interconnection: The result of the process of adding DER to an Area EPS, whether directly or via intermediate Local EPS facilities.

interconnection equipment: Individual or multiple devices used in an interconnection system.

interconnection system: The collection of all interconnection and interoperability equipment and functions, taken as a group, used to interconnect a DER to an Area EPS.²⁴

interface: An electrical or logical connection from one entity to another that supports one or more energy or data flows implemented with one or more power or data links.

interoperability: The capability of two or more networks, systems, devices, applications, or components to externally exchange and readily use information securely and effectively. (IEEE Std 2030[®] [B23])

²⁴This term was frequently used in IEEE Std 1547-2003. Given the scope of the present standard, which may have implications to the design of the entirety of the DER, this standard uses the term “DER” in most places.

inverter: A machine, device, or system that changes direct-current power to alternating-current power.

island: A condition in which a portion of an Area EPS is energized solely by one or more Local EPSs through the associated PCCs while that portion of the Area EPS is electrically separated from the rest of the Area EPS on all phases to which the DER is connected. When an island exists, the DER energizing the island may be said to be “islanding”.

load: Devices and processes in a local EPS that use electrical energy for utilization, exclusive of devices or processes that store energy but can return some or all of the energy to the local EPS or Area EPS in the future.

local DER communication interface: A local interface capable of communicating to support the information exchange requirements specified in this standard for all applicable functions that are supported in the DER.

local electric power system (Local EPS): An EPS contained entirely within a single premises or group of premises.

NOTE—See [Figure 2](#).

mandatory operation: Required continuance of active current and reactive current exchange of DER with Area EPS as prescribed, notwithstanding disturbances of the Area EPS voltage or frequency having magnitude and duration severity within defined limits.

mandatory operation region: The performance operating region corresponding to *mandatory operation*.

medium voltage: A class of nominal system voltages equal to or greater than 1 kV and less than or equal to 35 kV.

NOTE—IEEE standards are not unanimous in establishing the range for “medium voltage”.

momentary cessation: Temporarily *cease to energize* an EPS, while connected to the Area EPS, in response to a disturbance of the *applicable voltages* or the system frequency, with the capability of immediate Restore Output of operation when the *applicable voltages* and the system frequency return to within defined ranges.

momentary cessation operation region: The performance operating region corresponding to momentary cessation.

manufacturer stated measurement accuracy: Accuracy declared by the manufacturer, at which a DER measures the *applicable voltage*, current, power, frequency, or time.

nameplate ratings: Nominal voltage (V), current (A), maximum active power (kW), apparent power (kVA), and reactive power (kvar) at which a DER is capable of sustained operation.

NOTE—For Local EPS with multiple DER units, the aggregate DER nameplate rating is equal to the sum of all DERs nameplate rating in the Local EPS, not including aggregate capacity limiting mechanisms such as coincidence factors, plant controller limits, etc., that may be applicable for specific cases.

normal operating performance category: The grouping for a set of requirements that specify technical capabilities and settings for DER under normal operating conditions, i.e., inside the *continuous operation* region.

open loop response time: The duration from a step change in control signal input (reference value or system quantity) until the output changes by 90% of its final change, before any overshoot.

NOTE 1—The control loop considered in this definition refers to the DER control system in conjunction with the Area EPS. The “open loop” response time is equal to the DER control response time when the DER is interconnected with a stiff grid (ideal voltage source).

NOTE 2—The open loop response time is equal to 2.3 times the time constant of a first-order (i.e., single lag) system.

operating mode: Mode of DER operation that determines the performance during normal or abnormal conditions.

performance operating region: A region bounded by point pairs consisting of magnitude (voltage or frequency) and cumulative time duration which are used to define the operational performance requirements of the DER.

permissive operation: Operating mode where the DER performs ride-through either in *mandatory operation* or in *momentary cessation*, in response to a disturbance of the *applicable voltages* or the system frequency.

permissive operation region: The performance operating region corresponding to permissive operation.

permit service: A setting that indicates whether a DER is allowed to enter or remain in service.

per unit (p.u.) / percent of (%): Quantity expressed as a fraction of a defined base unit quantity. For active power (active current), the base quantity is the rated active power (rated active current). For apparent power (current), the base quantity is the rated apparent power (rated current). For system frequency, the base quantity is the nominal frequency (i.e., 60.0 Hz in North America). Quantities expressed in per unit can be converted to quantities expressed in percent of a base quantity by multiplication with 100.

point of common coupling (PCC): The point of connection between the Area EPS and the Local EPS.

NOTE 1—See [Figure 2](#).

NOTE 2—Equivalent, in most cases, to “service point” as specified in the National Electrical Code® (NEC®) [B31] and the National Electrical Safety Code® (NESC®) [B1].

point of distributed energy resources connection (point of DER connection–PoC): The point where a DER unit is electrically connected in a Local EPS and meets the requirements of this standard exclusive of any load present in the respective part of the Local EPS.

NOTE 1—See [Figure 2](#).

NOTE 2—For (a) DER unit(s) that are not self-sufficient to meet the requirements without (a) supplemental DER device(s), the point of DER connection is the point where the requirements of this standard are met by DER (a) device(s) in conjunction with (a) supplemental DER device(s) exclusive of any load present in the respective part of the Local EPS.

post-disturbance period: The period starting upon the return of all *applicable voltages* or the system frequency to the respective ranges of the *mandatory operation* region or *continuous operation* region.

pre-disturbance period: The time immediately before a *disturbance period*.

protective function(s): The behavior whose purpose is to maintain safe operations and/or maintain safe conditions.

range of allowable settings: The range within which settings may be adjusted to values other than the specified default settings.

reference point of applicability (RPA): The location where the interconnection and interoperability performance requirements specified in this standard apply.

regional reliability coordinator: The functional entity that maintains the real-time operating reliability of the bulk electric power within a reliability coordinator area.

restore output: Return operation of the DER to the state prior to the abnormal excursion of voltage or frequency that resulted in a ride-through operation of the DER.

return to service: Enter service following recovery from a trip.

ride-through: Ability to withstand voltage or frequency disturbances inside defined limits and to continue operating as specified.

simulated utility: An assembly of variable frequency and variable voltage test equipment used to simulate an Area EPS.

step response: The output as a function of time t when the input is a step.

supplemental DER device: Any equipment that is used to obtain compliance with some or all of the interconnection requirements of this standard.

NOTE—Examples include capacitor banks, STATCOMs, harmonic filters that are not part of a DER unit, protection devices, plant controllers, etc.

total rated-current distortion (TRD): The total root-sum-square of the current distortion components (including harmonics and inter-harmonics) created by the DER unit expressed as a percentage of the DER rated current capacity (I_{rated}).

trip: Inhibition of immediate return to service, which may involve disconnection.

NOTE—Trip executes or is subsequent to cessation of energization.

type test: A test of one or more devices manufactured to a certain design to demonstrate, or provide information that can be used to verify, that the design meets the requirements specified in this standard.

unintentional island: An unplanned island.

zero-sequence continuity: Circuit topology providing continuity between two defined points in the zero sequence network representation.

NOTE—A transformer that has a delta or ungrounded-*Wye* winding in the topological path between the defined points produces discontinuity of the zero-sequence network.

3.2 Acronyms

AGC	automatic generation control
AHJ	authority having jurisdiction
AGIR	authority governing interconnection requirements
Area EPS	area electric power system
Area EPS operator	area electric power system operator

BPS	bulk power system
DER	distributed energy resources
DER operator	distributed energy resources operator
EMS	energy management system
EMI	electromagnetic interference
EPS	electric power system
ESS	energy storage system
FIDVR	fault-induced delayed voltage recovery
Local EPS	local electric power system
NP	network protector
NRTL	nationally recognized testing laboratory
PCC	point of common coupling
PoC	point of DER connection
PV	photovoltaic
RMS	root mean square
ROCOF	rate of change of frequency
RPA	reference point of applicability
TRD	total rated-current distortion

4. General interconnection technical specifications and performance requirements

4.1 Introduction

The reference point of applicability (RPA) is the location where the interconnection and interoperability performance requirements specified in this standard shall be met. The electrical quantities referred to in this standard are those at the RPA, unless stated otherwise in this standard.

The performance requirements of this standard apply to interconnection of either a single DER unit based on that unit's rating or multiple DER units within a single Local EPS ("DER system"), based on the aggregate rating of all the DER units that are within the Local EPS. The capabilities and functions of the DER hardware and software that affect the *Area EPS* are required to meet this standard regardless of their location on the EPS. The performance requirements in this standard are functional and do not specify any particular equipment or equipment type.

The technical specifications and performance requirements specified here are universally needed for interconnection and interoperability of DER²⁵ and will be sufficient for most installations.²⁶ The applicability of certain specifications and requirements are dependent on application considerations. For these, the requirements are provided in terms of a limited number of technology-neutral *performance categories*, for which it is the responsibility of the *authority governing interconnection requirements*

²⁵ For example, synchronous machines, induction machines, or static power inverters/converters.

²⁶ Additional technical requirements may be necessary for some limited situations.

(AGIR) to determine applicability. Guidelines on criteria for assignment of DER *performance categories* are given in [Annex B](#).

DER shall be designed and installed such that it meets the performance and test and verification requirements described in [Clause 4](#) to [Clause 11](#) of this standard. Unless specified otherwise, the term “DER” means “DER system”. In specific cases, “DER unit” is explicitly stated.

4.2 Reference points of applicability (RPA)

The characteristics of the Local EPS and DER shall determine the *reference point of applicability* (RPA). Except as otherwise stated in this standard, the RPA for all performance requirements of this standard shall be the *point of common coupling* (PCC).

Alternatively, for Local EPSs where zero sequence continuity²⁷ between the PCC and PoC is maintained and either of the following conditions apply, the RPA for performance requirements of this standard may be the *point of DER connection* (PoC), or by mutual agreement between the *Area EPS* operator and the *DER operator*, at any point between, or including, the PoC and PCC:

- a) Aggregate DER nameplate rating of equal to or less than 500 kVA, *or*
- b) Annual average load demand²⁸ of greater than 10% of the aggregate DER nameplate rating, and where the Local EPS is not capable of, or is prevented from, exporting more than 500 kVA for longer than 30 s.

For all other Local EPSs meeting either of the conditions a) or b) above but not meeting the requirement for zero sequence continuity, the RPA for performance requirements other than the response to *Area EPS* abnormal conditions specified in [6.2](#) and [6.4](#) shall be the PoC, or by mutual agreement between the *Area EPS operator* and the *DER operator*, at any point between, or including, the PoC and PCC. The RPA for performance requirements of [6.2](#) and [6.4](#) shall be a point between, or including, the PoC and PCC that is appropriate to detect the abnormal voltage conditions.^{29, 30}

Where the RPA is not at the PCC, any equipment or devices in the Local EPS between the RPA and the PCC shall not preclude the DER from meeting the disturbance ride-through requirements specified in [6.4.2](#) and [6.5.2](#).³¹

For Local EPS where aggregate DER nameplate rating is greater than 500 kVA, and annual average load demand²⁸ is greater than 10% of the aggregate DER nameplate rating, and the Local EPS is capable of, and is not prevented from, exporting more than 500 kVA for longer than 30 s, the RPA shall be the PCC and

²⁷ When the zero sequence continuity is broken, for example by a delta-wye transformer between the PCC and the PoC, the voltages at the PoC may not be representative of the voltages at the PCC under abnormal voltage conditions. Examples of issues created by this condition include the following:

- Difficulty of ‘sensing’ single-phase-to-ground faults or failure to detect ground-fault overvoltages. Note that [7.4.1](#) specifies requirements for ground-fault overvoltage;
- Detecting abnormal voltage conditions when a DER back-feeds into the grid during a balanced open-phase condition;
- Ability of detecting Area EPS open-phase by the DER is diminished.

²⁸ As calculated by Area EPS operator.

²⁹ The intent of meeting the response to Area EPS abnormal voltage conditions requirements of [6.4](#) at the PCC is to appropriately detect ground faults and ground-fault overvoltage at the PCC.

³⁰ For DER that are permitted to use the PoC as the RPA, the location selected as the RPA may be different for each of the various functional requirements defined in [Clause 5](#).

³¹ Examples are undervoltage and overcurrent relays within the local EPS between the RPA and PCC that are set such that they may trip the DER during the voltage disturbance ride-through operation for short-circuit faults other than ones on the Area EPS circuit section to which the DER is connected. This does not preclude selectively tripping DER for faults on the Area EPS as specified in [6.2.1](#).

performance requirements specified in 5.2 for reactive power capability and in Clause 7 for power quality may be evaluated excluding the influence of the Local EPS load.

Figure H.1 illustrates a decision tree to determine the RPA for Local EPS where zero sequence continuity is maintained. Figure H.2 illustrates a decision tree to determine the RPA for Local EPS where zero sequence continuity is not maintained.

4.3 Applicable voltages

The *applicable voltages*³² determine the performance of a Local EPS or DER and are the electrical quantities specified with regard to the reference point of applicability, individual phase-to-neutral, phase-to-ground, or phase-to-phase combination and time resolution.

For DER with a PCC located at the medium-voltage level, the *applicable voltages* shall be determined by the configuration and nominal voltage of the Area EPS at the PCC. For DER with a PCC located at the low-voltage³³ level, the *applicable voltages* shall be determined by the configuration of the low-voltage winding of the Area EPS transformer(s) between the medium-voltage system and the low-voltage system. The *applicable voltages* that shall be detected are shown in Table 1 and Table 2. For multi-phase systems, the requirements for *applicable voltages* shall apply to all phases.

Table 1—Applicable voltages when PCC is located at medium voltage

Area EPS at PCC	Applicable voltages
Three-Phase, Four-Wire	Phase-to-phase and phase-to-neutral
Three-Phase, Three-Wire, Grounded	Phase-to-phase and phase-to-ground
Three-Phase, Three-Wire, Ungrounded	Phase-to-phase
Single-Phase, Two-Wire	Phase-to-2nd wire (the 2nd wire may be either a neutral or a 2nd phase)

Table 2—Applicable voltages when PCC is located at low voltage

Low-voltage winding configuration of Area EPS transformer(s) ^a	Applicable voltages
Grounded Wye, Tee, or Zig-Zag ^b	Phase-to-phase and phase-to-neutral, or Phase-to-phase and phase-to-ground
Ungrounded Wye, Tee, or Zig-Zag	Phase-to-phase or phase-to-neutral
Delta ^c	Phase-to-phase
Single-Phase 120/240 V (split-phase or Edison connection)	Line-to-neutral—for 120 V DER units Line-to-line—for 240 V DER units ^d

^aA three-phase transformer or a bank of single-phase transformers may be used for three-phase systems.

^bFor 120/208 V two-phase services, line-to-line voltages shall be sufficient.

^cIncluding delta with mid tap connection (grounded or ungrounded).

^dSensing line-to-neutral on both legs of a 120/240 V split-phase or Edison connection effectively senses the line-to-line and is therefore compliant with this requirement. Sensing line-to-ground may also be used; however, the ground connection should only be used for voltage sensing purposes.

The applicable frequency is the fundamental-frequency component. The *applicable voltages* shall be quantified as the effective (RMS) values over the preceding fundamental frequency period, unless otherwise specified in this standard.

³² *Applicable voltages* are used in synonym for *applicable frequency*, which can be derived from the *applicable voltages*.

³³ 1000 V and less per IEEE Std C62.41.2 and IEEE Std C62.45.

For voltage-reactive power³⁴ (volt-var) mode requirements in 5.3.3 and voltage-active (real) power³⁵ mode requirements in 5.4.2 where DER do not respond to individual phase voltages, the *applicable voltages* are quantified as the average of the three-phase effective (RMS) values or alternatively positive sequence component of voltages over one fundamental frequency period.

For voltage trip and ride-through requirements in 6.4, the following shall apply:

- For low-voltage ride-through and undervoltage trip, the relevant voltage at any given time shall be the least magnitude of the individual *applicable voltages* relative to the corresponding nominal voltage.
- For high-voltage ride-through and overvoltage trip, the relevant voltage at any given time shall be the greatest magnitude of the *applicable voltages* relative to the corresponding nominal voltage.

For rate of change of frequency (ROCOF) ride-through requirements in 6.5.2.5, the ROCOF shall be the average rate of change of frequency over an averaging window of at least 0.1 s.

4.4 Measurement accuracy

The DER³⁶ shall meet the minimum steady-state³⁷ and transient³⁸ measurement and calculation³⁹ accuracy requirements for voltage, frequency, active power, reactive power, and time as specified in Table 3. Actual measurement and calculation accuracy of a DER shall be stated for each of the values above.

Table 3—Minimum measurement and calculation accuracy requirements for manufacturers^a

Time frame	Steady-state measurements			Transient measurements		
	Minimum measurement accuracy	Measurement window	Range	Minimum measurement accuracy	Measurement window	Range
Voltage, RMS	(± 1% V_{nom})	10 cycles	0.5 p.u. to 1.2 p.u.	(± 2% V_{nom})	5 cycles	0.5 p.u. to 1.2 p.u.
Frequency ^b	10 mHz	60 cycles	50 Hz to 66 Hz	100 mHz	5 cycles	50 Hz to 66 Hz
Active Power	(± 5% S_{rated})	10 cycles	0.2 p.u. < P < 1.0 p.u.	Not required	N/A	N/A
Reactive Power	(± 5% S_{rated})	10 cycles	0.2 p.u. < Q < 1.0 p.u.	Not required	N/A	N/A
Time	1% of measured duration	N/A	5 s to 600 s	2 cycles	N/A	100 ms < 5 s

^aMeasurement accuracy requirements specified in this table are applicable for voltage THD < 2.5% and individual voltage harmonics < 1.5%.

^bAccuracy requirements for frequency are applicable only when the fundamental voltage is greater than 30% of the nominal voltage.

³⁴ Voltage-reactive power mode may also be commonly referred to as “volt-var” mode.

³⁵ Voltage-active power mode may also be commonly referred to as “volt-watt” mode.

³⁶ The DER includes any equipment required to meet the interconnection performance and interoperability requirements of the standard, including protective relays and measurement transducers.

³⁷ Steady-state measurements may be used for providing monitoring information through a *local DER communication interface* at the reference point of applicability as specified in Table 29 in 10.5.

³⁸ Transient measurements can be used by protective relays for achieving the mandatory voltage and frequency-tripping requirements as specified in 6.4.1 and 6.5.1.

³⁹ Only the fundamental parameters can actually be measured, e.g., time, voltage, and current. Other quantities are calculated based on the fundamental parameters measured, e.g., frequency, active power, and reactive power.

4.5 Cease to energize performance requirement

In the *cease to energize* state, the DER shall not deliver active power during steady-state or transient conditions. The requirements for *cease to energize* shall apply to the point of DER connection (PoC).

For Local EPS with aggregate DER rating less than 500 kVA, the reactive power exchange in the *cease to energize* state shall be less than 10% of nameplate DER rating and shall exclusively result from passive devices. For Local EPS with aggregate DER rating 500 kVA and greater, the reactive power exchange in the *cease to energize* state shall be less than 3% of nameplate DER rating and shall exclusively result from passive devices.⁴⁰

If requested by the Area EPS operator, the DER operator shall provide the reactive susceptance that remains connected to the Area EPS in the *cease to energize* state.

Import of active power and reactive power exchange in the *cease to energize* state is permitted only for continuation of supply to DER housekeeping and auxiliary loads.

Alternatively, the requirements for *cease to energize* may be met by disconnecting⁴¹ the local EPS, or the portion of the local EPS to which the DER is connected from the Area EPS. The DER may continue to deliver power to the portion of the Local EPS that is disconnected from the Area EPS.⁴²

4.6 Control capability requirements

The DER shall be capable of responding to external inputs⁴³ as specified in this subclause.

4.6.1 Capability to disable permit service

The DER shall be capable of disabling the permit service setting and shall *cease to energize* the Area EPS and trip in no more than 2 s.⁴⁴

4.6.2 Capability to limit active power

The DER shall be capable of limiting active power as a percentage of the nameplate active power rating. The DER shall limit its active power output to not greater than the active power limit set point in no more than 30 s or in the time it takes for the primary energy source to reduce its active power output to achieve the requirements of the active power limit set point, whichever is greater.⁴⁵ In cases where the DER is supplying loads in the Local EPS, the active power limit set point may be implemented as a maximum active power export to the Area EPS. Under mutual agreement between the *Area EPS operator* and the *DER operator*, the DER may be required to reduce active power below the level needed to support Local EPS loads.

⁴⁰ In cases where the Area EPS is isolated, the passive reactive power devices of the DER will rapidly discharge by Area EPS loads and transformer magnetization and cease to exchange reactive power with the isolated Area EPS.

⁴¹ For example, via a separate disconnection device.

⁴² This may allow DER units to continue to energize the isolated Local EPS and supply local loads when disconnected from the Area EPS.

⁴³ The external input may come through a manual DER control panel or through the *local DER communication interface* specified in [Clause 10](#).

⁴⁴ This function is not intended to necessarily meet all requirements for protection, such as direct transfer trip. The objective of this requirement is related to bulk system operation.

⁴⁵ Linear ramping and step-wise ramping with small step sizes may be desirable.

4.6.3 Execution of mode or parameter changes

Transition between modes shall commence in no more than 30 s after the mode setting change is received at the local DER communication interface. Changes of control functional modes shall be executed such that the DER output is transitioned smoothly over a time period between 5 s and 300 s.

Ramping of DER output is not required for control parameter setting changes. For all control and protective function parameter settings, the time following the input to the *local DER communication interface* and preceding the point in time when the invoked action begins shall be no greater than 30 s.

4.7 Prioritization of DER responses

Requirements set forth in [Clause 5](#) and [Clause 6](#) shall be prioritized as follows:⁴⁶

- a) The response to disabling permit service setting specified in [4.6.1](#) shall take precedence over any requirements within [Clause 5](#) and [Clause 6](#).
- b) DER tripping requirements specified in [6.2](#), [6.4.1](#), and [6.5.1](#) shall take precedence over any other requirements within [Clause 5](#) and [Clause 6](#), subject to the following:
 - 1) Where the prescribed trip duration settings for the respective voltage or frequency magnitude are set at least 160 ms or 1% of the prescribed tripping time, whichever is greater, beyond the prescribed ride-through duration, the DER shall comply with the ride-through requirements specified in [6.4.2](#) and [6.5.2](#) prior to tripping.
 - 2) In all other cases, the ride-through requirements shall apply until 160 ms or 1% of the prescribed tripping time, whichever is greater, prior to the prescribed tripping time.
- c) DER ride-through requirements specified in [6.4.2](#) and [6.5.2](#) shall take precedence over all other requirements within [Clause 5](#) and [Clause 6](#), with the exception of tripping requirements listed in item b) above. Ride-through may be terminated by the detection of an *unintentional island* specified in [8.1](#). However, false detection of an *unintentional island* that does not actually exist shall not justify non-compliance with ride-through requirements. Conversely, ride-through requirements specified in [Clause 6](#) shall not inhibit the islanding detection performance specified in [8.1](#) where a valid unintentional islanding condition exists.
- d) The voltage-active power mode requirements specified in [5.4.2](#) and frequency-droop (frequency-power) response requirements specified in [6.5.2.7](#) shall take precedence over all other requirements within [Clause 5](#) and [Clause 6](#), with the exception of tripping and ride-through requirements listed in item b) and item c) above. If both voltage-active power and frequency-droop modes are active, the lesser of the power value shall take precedence.
- e) The response to active power limit signal specified in [4.6.2](#) shall take precedence over all other requirements within [Clause 5](#) and [Clause 6](#), with the exception of tripping and ride-through requirements listed in item b) and item c) above, and voltage-active power mode requirements and frequency-droop response requirements listed in item d).
- f) The voltage regulation functions specified in [5.3](#) shall take precedence over any remaining requirements within [Clause 5](#) and [Clause 6](#).

⁴⁶ Based on the actual settings of the control modes, a mode with lower priority may still take effect prior to a mode with higher priority.

4.8 Isolation device

When required by the Area EPS operating practices, a readily accessible, lockable, visible-break isolation device shall be located between the Area EPS and the DER.⁴⁷

4.9 Inadvertent energization of the Area EPS

The DER shall not energize the Area EPS when the Area EPS is de-energized. Exceptions may be given for *intentional Area EPS islands* per 8.2 at the discretion of the Area EPS operator.

4.10 Enter service

4.10.1 Introduction

The *enter service* criteria for DER of Category I, Category II, and Category III are specified in Table 4.⁴⁸ The active power performance during entering service is specified in 4.10.3. The requirements of 4.10 apply equally for return to service after trip as specified in 6.6.

4.10.2 Enter service criteria

When entering service, the DER shall not energize the Area EPS until the *applicable voltage* and system frequency are within the ranges specified in Table 4 and the permit service setting is set to “Enabled”.⁴⁹

Table 4—Enter service criteria for DER of Category I, Category II, and Category III

Enter service criteria		Default settings	Ranges of allowable settings
Permit service		Enabled	Enabled/Disabled
Applicable voltage within range	Minimum value	≥ 0.917 p.u. ^a	0.88 p.u. to 0.95 p.u.
	Maximum value	≤ 1.05 p.u.	1.05 p.u. to 1.06 p.u.
Frequency within range	Minimum value	≥ 59.5 Hz	59.0 Hz to 59.9 Hz
	Maximum value	≤ 60.1 Hz	60.1 Hz to 61.0 Hz

^aThis corresponds to the Range B of ANSI C84.1, Table 1, column for service voltage of 120–600 V.

4.10.3 Performance during entering service

During entering service, the DER shall be capable of the following:

- a) Prevent *enter service* when permit service setting is disabled.
- b) DER shall be capable of delaying *enter service* by an intentional adjustable minimum delay when the Area EPS steady-state voltage and frequency are within the ranges specified in Table 4. The adjustable range of the minimum intentional delay shall be 0 s to 600 s with a default minimum delay of 300 s.

⁴⁷ The isolation device should be clearly marked to include signage per The National Electrical Code® [B31], as applicable.

⁴⁸ Refer to Annex B for more information on categories.

⁴⁹ The *enter service* criteria in Table 4 specify the conditions for which a DER is permitted to *enter service*; these criteria do not mandate any DER to *enter service* or stay in operation for the specified voltage and frequency conditions.

- c) DER shall increase output of active power,⁵⁰ or exchange of active power for energy-storage-DER, during *enter service* as specified. Active power shall increase linearly, or in a stepwise linear ramp, with an average rate-of-change not exceeding the DER nameplate active power rating divided by the enter service period. The duration of the *enter service* period shall be adjustable over a range of 1 s to 1000 s with a default time of 300 s.⁵¹ The maximum active power increase of any single step during the *enter service* period shall be less than or equal to 20% of the DER nameplate active power rating. Where a stepwise ramp is used, the rate of change over the period between any two consecutive steps shall not exceed the average rate-of-change over the full *enter service* period. This requirement is a maximum ramp rate requirement and the DER may increase output slower than specified.

Exception 1: For Local EPS that have an aggregate DER rating of less than 500 kVA, individual DER units may increase output of active power with no limitation of the rate-of-change, following an additional randomized time delay with a default maximum time random interval of 300 s, and with an adjustable range for the maximum time random interval of 1 s to 1000 s.

Exception 2: Increase of output of active power by Local EPS having an aggregate DER rating of equal to or greater than 500 kVA and increasing output with active power steps greater than 20% of nameplate active power rating shall require approval of the Area EPS operator in coordination with the regional reliability coordinator.

4.10.4 Synchronization

The DER shall parallel with the Area EPS without causing step changes in the RMS voltage at the PCC exceeding 3% of nominal when the PCC is at medium voltage, or exceeding 5% of nominal when the PCC is at low voltage.

DER that produce fundamental voltage before connecting to the Area EPS⁵² shall not be synchronized outside of the tolerances specified in Table 5.^{53, 54} The synchronization limits stated in Table 5 may be waived by the Area EPS operator if paralleling does not exceed the limitation of voltage fluctuations induced by the DER requirements specified in 7.2.

⁵⁰ For Restore Output of active power after Return to Service, direction of active power may be negative (charging) for Energy Storage DER, e.g., return to frequency reduction via charging through droop or dispatch control, if operating for that purpose prior to trip. This requirement does not exclude use of alternate means to meet this requirement.

⁵¹ Base values for quantities expressed in per unit and percent of are specified in 3.1.

⁵² Examples may include synchronous generators, self-excited (grid-forming) inverters, or self-excited induction generators.

⁵³ These parameters are maximum synchronization tolerances and by no means require that DER equipment be designed to sustain these tolerances. If the equipment requires tighter tolerances and the synchronization is performed consistent with the equipment requirements, then the synchronization will be compliant with this subclause.

⁵⁴ For example, round rotor synchronous generators with ratings 10 MVA and larger and salient pole synchronous generators with ratings 5 MVA and larger may use the synchronization criteria described in IEEE Std 67, which are tighter than the ones specified here and can therefore meet the requirements of this standard.

Table 5—Synchronization parameter limits for synchronous interconnection to an EPS, or an energized Local EPS to an energized Area EPS

Aggregate rating of DER units (kVA)	Frequency difference (Δf , Hz)	Voltage difference (ΔV , %)	Phase angle difference ($\Delta \Phi$, °)
0–500	0.3	10	20
> 500–1 500	0.2	5	15
> 1 500	0.1	3	10

4.11 Interconnect integrity

4.11.1 Protection from electromagnetic interference (EMI)

The DER shall be compliant with IEEE Std C37.90.2, IEC 61000-4-3, or other applicable industry standards with a minimum electric field strength of 30 V/m.⁵⁵ The influence of EMI, having an electric field less than or equal to the value specified in this subclause, shall not result in a change in state or misoperation of the DER that affects performance required by this standard.

4.11.2 Surge withstand performance

The interconnection system shall have the capability to withstand voltage and current surges in accordance with the interconnection system ratings and environments defined in IEEE Std C62.41.2, IEEE Std C37.90.1, IEEE Std C62.45, or IEC 61000-4-5, as applicable.

4.11.3 Paralleling device

Where used for isolation of a DER unit that continues to produce voltage after isolation from the Area EPS, the DER paralleling-device shall be capable of withstanding 220% of the DER rated voltage across the paralleling device for an indefinite duration.⁵⁶

4.12 Integration with Area EPS grounding

Unless specified otherwise by the Area EPS operator, the grounding scheme of the DER interconnection shall be coordinated with the ground fault protection of the Area EPS.⁵⁷

4.13 Exemptions for emergency systems and standby DER

4.13.1 Exemptions for emergency systems

DER systems designated by *authority having jurisdiction* as emergency, legally required, or critical operations power systems providing backup power to hospitals, fire stations or other emergency facilities as defined by applicable industry code,⁵⁸ shall be exempt from the following:

⁵⁵ Information on references can be found in [Clause 2](#).

⁵⁶ The paralleling device must be rated for 220% of nominal voltage to accommodate Area EPS and DER voltages that are out of phase with each other.

⁵⁷ Subclause 7.4 limits overvoltages produced by DER, including overvoltages caused by ground faults.

⁵⁸ In the United States, examples of applicable industry code are NFPA 110 [\[B32\]](#), NFPA 70 [\[B31\]](#), or the NESC [\[B1\]](#).

- a) Voltage disturbance ride-through requirements specified in 6.4.2
- b) Frequency disturbance ride-through requirements specified in 6.5.2
- c) Interoperability, information exchange, information models, and protocols specified in Clause 10
- d) Intentional islanding requirements specified in 8.2

and may *cease to energize* the Area EPS or may separate from the Area EPS without limitations.

4.13.2 Exemptions for standby DER

A DER that is only being operated in parallel to the Area EPS:

- For testing purposes only and tests are not performed more frequently than 30 times per year; or
- During load transfer in a period of less than 300 s to or from the Area EPS,

shall be exempt from the following:

- a) Voltage disturbance ride-through requirements specified in 6.4.2
- b) Frequency disturbance ride-through requirements specified in 6.5.2
- c) Interoperability, information exchange, information models, and protocols specified in Clause 10
- d) Intentional islanding requirements specified in 8.2

and may *cease to energize* the Area EPS or may separate from the Area EPS without limitations.

5. Reactive power capability and voltage/power control requirements

5.1 Introduction

Different characteristics and capabilities for response to voltage variations within the normal operating range are specified in certain parts of this subclause for *normal operating performance* Category A and Category B DER.⁵⁹ Table 6 specifies the attributes of voltage and reactive power control requirements specified in 5.3 and the voltage and active power control requirements specified in 5.4 to performance Category A and Category B DER. Under mutual agreement between Area EPS operator and DER operator, requirements other than those specified below are also permitted.

The Area EPS operator shall specify the DER performance category that is required. Guidance regarding the assignment of performance categories is provided in Annex B of this standard covering DER type, application purpose, and Area EPS characteristics.

The requirements of this subclause apply to the *continuous operation region* when the voltage is between 0.88 and 1.1 times the nominal voltage (V_N). Continued operation of functions defined in Clause 5 outside of the *continuous operation region* may be acceptable to support functions covered in 6.4. During abnormal voltage conditions, this reactive power range shall be provided subject to the limitations of the DER. The DER shall return to its pre-disturbance operating mode after the system voltage returns to its normal range.

The DER shall not cause the Area EPS primary circuit voltage at any location to go outside the requirements of ANSI C84.1 for primary service voltage.

⁵⁹ Refer to Annex B for definitions of Category A and Category B.

In addition, the DER shall not cause the Area EPS service voltage at any Local EPS to be outside of ANSI C84.1. This service voltage limitation shall not apply to the DER’s Local EPS if it is served by a dedicated service transformer or dedicated feeder/circuit as determined by the Area EPS operator.

Table 6—Voltage and reactive/active power control function requirements for DER normal operating performance categories

DER category	Category A	Category B
Voltage regulation by reactive power control		
Constant power factor mode	Mandatory	Mandatory
Voltage—reactive power mode ^a	Mandatory	Mandatory
Active power—reactive power mode ^b	Not required	Mandatory
Constant reactive power mode	Mandatory	Mandatory
Voltage and active power control		
Voltage—active power (volt-watt) mode	Not required	Mandatory

^aVoltage-reactive power mode may also be commonly referred to as “volt-var” mode.

^bActive power-reactive power mode may be commonly referred to as “watt-var” mode.

5.2 Reactive power capability of the DER

The DER shall be capable of injecting reactive power (over-excited) and absorbing reactive power (under-excited) for active power output levels greater than or equal to the minimum steady-state active power capability (P_{min}), or 5% of rated active power, P_{rated} (kW) of the DER, whichever is greater.

When operating at active power output greater than 5% and less than 20% of rated active power, the DER shall be capable of exchanging reactive power up to the minimum reactive power value given in [Table 7](#) multiplied by the active power output divided by 20% of rated active power.

Operation at any active power output above 20% of rated active power shall not constrain the delivery of reactive power injection or absorption, up to the capability specified in [Table 7](#), as required by the active control function at the time, as defined in [5.3](#). Curtailment of active power to meet apparent power constraints is permissible. These reactive power requirements are illustrated in informative [Figure H.3](#).⁶⁰

Table 7—Minimum reactive power injection and absorption capability

Category	Injection capability as % of nameplate apparent power (kVA) rating	Absorption capability as % of nameplate apparent power (kVA) rating
A (at DER rated voltage)	44	25
B (over the full extent of ANSI C84.1 range A)	44	44

The DER may produce active power up to the kVA rating provided that the DER remains capable at all times to absorb or inject reactive power, to the full extent of the reactive power capability ranges defined above, as demanded by the reactive power control mode and corresponding settings established by the Area EPS operator.⁶¹

⁶⁰ This is commonly known as “reactive power priority” mode.

⁶¹ The DER P_{rated} may be less than or equal to S_{rated} . The DER may need to reduce active power in order to meet the demanded reactive power in order to respect its apparent power limits.

5.3 Voltage and reactive power control

5.3.1 General

The DER shall provide voltage regulation capability by changes of reactive power. The approval of the Area EPS operator shall be required for the DER to actively participate in voltage regulation.

The voltage and reactive power control functions do not create a requirement for the DER to operate at points outside of the minimum reactive power capabilities specified in 5.2.

The DER shall, as specified in Table 6, provide the capabilities of the following mutually exclusive modes of reactive power control functions:

- Constant power factor mode
- Voltage-reactive power mode
- Active power-reactive power mode
- Constant reactive power mode

The DER shall be capable of activating each of these modes one at a time.

Constant power factor mode with unity power factor setting⁶² shall be the default mode of the installed DER unless otherwise specified by the Area EPS operator.

The DER operator shall be responsible for implementing setting modifications and mode selections, as specified by the Area EPS operator within a time acceptable to the Area EPS operator. Under mutual agreement between the Area EPS operator and DER operator, reactive power control modes and implementations other than the ones listed above and described below shall be permitted.

Emergency or standby DERs⁶³ as specified in 4.13 shall only be required to operate in constant power factor mode.

5.3.2 Constant power factor mode

When in this mode, the DER shall operate at a constant power factor. The target power factor shall be specified by the Area EPS operator and shall not require reactive power exceeding the reactive capability requirements specified in 5.2. The power factor settings are allowed to be adjusted locally and/or remotely as specified by the Area EPS operator. The maximum DER response time to maintain constant power factor shall be 10 s or less.

5.3.3 Voltage-reactive power mode⁶⁴

When in this mode, the DER shall actively control its reactive power output as a function of voltage following a voltage-reactive power piecewise linear characteristic. An example voltage-reactive power characteristic is shown in Figure H.4. The voltage-reactive power characteristic shall be configured in accordance with the default parameter values specified in Table 8 if not specified by the Area EPS

⁶² DER may operate at any power factor, e.g., for the purpose of compensating for the reactive power demand of the Local EPS, as long as the power factor requirements specified by the Area EPS are met at the RPA.

⁶³ As defined by authority having jurisdiction.

⁶⁴ Category A default operation under voltage-reactive power mode is sometimes called 'voltage regulation with reactive droop'. Note however, that Category B deviates significantly from Category A operation.

operator. If specified by the Area EPS operator, the voltage-reactive power characteristic shall be configured using values in the optional adjustable range. The voltage-reactive power characteristics shall be adjustable locally and/or remotely as specified by the Area EPS operator.

**Table 8—Voltage-reactive power settings for normal operating performance
Category A and Category B DER**

Voltage-reactive power parameters	Default settings		Ranges of allowable settings	
	Category A	Category B	Minimum	Maximum
V_{Ref}	V_N	V_N	$0.95 V_N$	$1.05 V_N$
V_2	V_N	$V_{Ref} - 0.02 V_N$	Category A: V_{Ref} Category B: $V_{Ref} - 0.03 V_N$	V_{Ref}^c
Q_2	0	0	100% of nameplate reactive power capability, absorption	100% of nameplate reactive power capability, injection
V_3	V_N	$V_{Ref} + 0.02 V_N$	V_{Ref}^c	Category A: V_{Ref} Category B: $V_{Ref} + 0.03 V_N$
Q_3	0	0	100% of nameplate reactive power capability, absorption	100% of nameplate reactive power capability, injection
V_1	$0.9 V_N$	$V_{Ref} - 0.08 V_N$	$V_{Ref} - 0.18 V_N$	$V_2 - 0.02 V_N^c$
Q_1^a	25% of nameplate apparent power rating, injection	44% of nameplate apparent power rating, injection	0	100% of nameplate reactive power capability, injection ^b
V_4	$1.1 V_N$	$V_{Ref} + 0.08 V_N$	$V_3 + 0.02 V_N^c$	$V_{Ref} + 0.18 V_N$
Q_4	25% of nameplate apparent power rating, absorption	44% of nameplate apparent power rating, absorption	100% of nameplate reactive power capability, absorption	0
Open loop response time	10 s	5 s	1 s	90 s

^aThe DER reactive power capability may be reduced at lower voltage.

^bIf needed DER may reduce active power output to meet this requirement.

^cImproper selection of these values may cause system instability.

The DER shall be capable of autonomously adjusting reference voltage (V_{Ref}) with V_{Ref} being equal to the low pass filtered measured voltage. The time constant shall be adjustable at least over the range of 300 s to 5000 s. The voltage-reactive power Volt-Var curve characteristic shall be adjusted autonomously as V_{Ref} changes. The approval of the Area EPS operator shall be required for the DER to autonomously adjust the reference voltage. Implementation of the autonomous V_{Ref} adjustability and the associated time constant shall be specified by the Area EPS operator.

5.3.4 Active power-reactive power mode

When in this mode, the DER shall actively control the reactive power output as a function of the active power output following a target piecewise linear active power-reactive power characteristic, without intentional time delay. In no case, shall the response time be greater than 10 s. Example active power-reactive power characteristic is shown in Figure H.5. The target characteristic shall be configured in accordance with the default parameter values shown in Table 9. The characteristics shall be allowed to be configured as specified by the Area EPS operator using the values specified in the optional adjustable range.

The left-hand side of Figure H.5 and corresponding requirements specified in Table 9 shall only apply to DER capable of absorbing active power.

The active power-reactive power characteristics are allowed to be adjusted locally and/or remotely as specified by the Area EPS operator.

**Table 9—Active power-reactive power settings for normal operating performance
Category A and Category B DER**

Active power-reactive power parameters	Default settings		Ranges of allowable settings	
	Category A	Category B	Minimum	Maximum
P_3	P_{rated}		$P_2 + 0.1 P_{\text{rated}}$	P_{rated}
P_2	$0.5 P_{\text{rated}}$		$0.4 P_{\text{rated}}$	$0.8 P_{\text{rated}}$
P_1	The greater of $0.2 P_{\text{rated}}$ and P_{min}		P_{min}	$P_2 - 0.1 P_{\text{rated}}$
P'_1	The lesser of $0.2 \times P_{\text{rated}}$ and P'_{min}		$P'_2 - 0.1 P'_{\text{rated}}$	P'_{min}
P'_2	$0.5 P'_{\text{rated}}$		$0.8 P'_{\text{rated}}$	$0.4 P'_{\text{rated}}$
P'_3	P'_{rated}		P'_{rated}	$P'_2 + 0.1 P'_{\text{rated}}$
Q_3	25% of nameplate apparent power rating, absorption	44% of nameplate apparent power rating, absorption	100% of nameplate reactive power absorption capability	100% of nameplate reactive power injection capability
Q_2	0			
Q_1	0			
Q'_1	0			
Q'_2	0			
Q'_3	44% of nameplate apparent power rating, injection			
NOTE— P_{rated} is the nameplate active power rating of the DER. P'_{rated} is the maximum active power that the DER can absorb. P_{min} is the minimum active power output of the DER. P'_{min} is the minimum, in amplitude, active power that the DER can absorb. P' parameters are negative in value.				

5.3.5 Constant reactive power mode

When in this mode, the DER shall maintain a constant reactive power. The target reactive power level and mode (injection or absorption) shall be specified by the Area EPS operator and shall be within the range specified in 5.2. The reactive power settings are allowed to be adjusted locally and/or remotely as specified by the Area EPS operator. The maximum DER response time to maintain constant reactive power shall be 10 s or less.

5.4 Voltage and active power control

5.4.1 General

Category B DER shall, as specified in Table 6, provide a voltage regulation capability by changes of active power. Enabling/disabling this function is at the discretion of the Area EPS operator. The default is that this function is disabled.

5.4.2 Voltage-active power mode

When in this mode, the DER shall actively limit the DER maximum active power as a function of the voltage following a voltage-active power piecewise linear characteristic. Two examples of these characteristics are shown in Figure H.6. The characteristic shall be configured in accordance with the default parameter values specified in Table 10 for the given DER *normal operating performance category*. The characteristic may be configured as specified by the Area EPS operator using the values in the adjustable range.⁶⁵

If enabled, the voltage-active power mode shall remain active while any of the voltage-reactive power modes described in 5.3 are enabled. For DER that do not absorb active power, P_2 , which is the minimum set point for active power generation due to overvoltage, is subject to the equipment capability. If P_2 is outside the *continuous operation region* of the DER, the active power generation is allowed to be reduced to the minimum DER capability instead of P_2 or DER shutting down.

DER that can inject and absorb active power, P_2 , which is the maximum set point for active power absorption change due to system overvoltage, is subject to the equipment capability. If P_2 is outside the *continuous operation region* of the DER, the active power absorption is allowed to be reduced to the maximum absorption capability instead of P_2 or DER shutting down.

The voltage-active power characteristics curves are allowed to be adjusted locally and/or remotely as specified by the Area EPS operator.

Table 10—Voltage-active power settings for Category A and Category B DER

Voltage-active power parameters	Default settings	Ranges of allowable settings	
		Minimum	Maximum
V_1	$1.06 V_N$	$1.05 V_N$	$1.09 V_N$
P_1	P_{rated}	N/A	N/A
V_2	$1.1 V_N$	$V_1 + 0.01 V_N$	$1.10 V_N$
P_2 (applicable to DER that can only generate active power)	The lesser of $0.2 P_{\text{rated}}$ or P_{min}^a	P_{min}	P_{rated}
P_2 (applicable to DER that can generate and absorb active power)	0^b	0	P_{rated}
Open Loop Response Time	10 s ^c	0.5 s	60 s

^a P_{min} is the minimum active power output in p.u. of the DER rating (i.e., 1.0 p.u.).

^b P_{rated} is the maximum amount of active power that can be absorbed by the DER. ESS operating in the negative real power half plane, through charging, shall follow this curve as long as available energy storage capacity permits this operation.

^cAny settings for the open loop response time of less than 3 s shall be approved by the Area EPS operator with due consideration of system dynamic oscillatory behavior.

⁶⁵ As permitted by 4.6.2, for cases where the DER is supplying loads in the Local EPS, the DER active power may be implemented as a maximum active power export limit set point. The DER shall not be required to reduce active power below the level needed to support local loads.

6. Response to Area EPS abnormal conditions

6.1 Introduction

Abnormal conditions can arise on the Area EPS to which the DER shall appropriately respond. This response contributes to the stability of the Area EPS, safety of utility maintenance personnel and the general public, as well as the avoidance of damage to connected equipment, including the DER. DER response should consider the performance requirements of the Area EPS and the *bulk power system* (BPS) to which the Area EPS is connected.⁶⁶ All performance requirements specified in these subclauses shall be met at the *reference point of applicability* specified in 4.2 and shall refer to the *applicable voltages* specified in 4.3,⁶⁷ unless otherwise stated.

Different characteristics and capabilities for response to abnormal Area EPS conditions are specified in certain parts of this subclause for *abnormal operating performance* Category I, Category II, and Category III DER.

The Area EPS operator, as guided by the AGIR who determined applicability of the performance categories as outlined in 4.3,⁶⁸ shall specify which of *abnormal operating performance* Category I, Category II, or Category III performance is required.⁶⁹ Guidance regarding the assignment of *performance categories* is provided in Annex B of this standard.

With regard to ride-through as specified in 6.4.2 and 6.5.2 and methods utilized to meet the unintentional islanding detection as specified in 8.1, the following shall apply:

- While the DER is connected to an Area EPS that is connected to a *bulk power system*, any requirements for ride-through as specified in 6.4.2 and 6.5.2 shall not be falsely inhibited by any methods or design features utilized to meet the unintentional islanding detection as specified in 8.1 when an actual *unintentional island* condition does not exist.
- Conversely, the unintentional islanding detection requirements specified in 8.1 shall not be inhibited by ride-through as specified in 6.4.2 and 6.5.2 during valid unintentional islanding conditions.⁷⁰
- While the DER is connected to an Area EPS that is not connected to a *bulk power system* (i.e., an *intentional Area EPS island*), requirements for ride-through as specified in 6.4.2 and 6.5.2 may not apply.⁷¹

All requirements related to the delivery of active power shall be subject to the availability of the DER's primary source of energy (*available active power*).⁷² Abnormal voltage and frequency conditions shall not result in unavailability of DER's primary source of energy (*available active power*); otherwise, this shall be

⁶⁶ Distributed Energy Resources—Connection, Modeling, and Reliability Considerations, North American Electric Reliability Corporation (NERC), February 2017.

⁶⁷ Subclause 4.3 states: For low-voltage ride-through and undervoltage trip, the relevant voltage at any given time shall be the least magnitude of the individual *applicable voltages* relative to the corresponding nominal voltage. For high-voltage ride-through and overvoltage trip, the relevant voltage at any given time shall be the greatest magnitude of the *applicable voltages* relative to the corresponding nominal voltage.

⁶⁸ Refer to Annex B for further guidelines for DER performance category assignment.

⁶⁹ This may be subject to regulatory requirements that are outside the scope of this standard and may consider DER type, application purpose, future regional DER penetration, and the Area EPS characteristics.

⁷⁰ Also refer to prioritization of DER responses as specified in 4.7.

⁷¹ Subclause 8.2 specifies requirements and criteria for *intentional Area EPS islands* and DER operating within an *intentional Area EPS island*.

⁷² Decrease of solar irradiance in the case of a photovoltaic DER, or decrease of wind speed for a wind turbine generator, occurring during a voltage disturbance, are examples where DER power output decrease is compliant with this requirement.

deemed a failure to comply with ride-through of abnormal voltage and frequency conditions of this clause.⁷³

All DER shall be field adjustable for the adjustable parameters specified in this clause.⁷⁴ The adjustability may be required via communication, if specified by the Area EPS operator as defined per the interoperability requirements specified in [Clause 10](#).

The actual applied trip settings shall be specified by the Area EPS operator. If the Area EPS operator does not specify any settings, the default settings shall be used.

6.2 Area EPS faults and open phase conditions

6.2.1 Area EPS faults

For short-circuit faults on the Area EPS circuit section to which the DER is connected, the DER shall *cease to energize* and *trip* unless specified otherwise by the Area EPS operator.⁷⁵ This requirement shall not be applicable to faults that cannot be detected by the Area EPS protection systems.

NOTE 1—DER can desensitize detection of faults that can be detected by the Area EPS protection systems prior to the interconnection of the DER. Adjustments to the settings of the Area EPS protection systems or changes to the DER interconnection parameters, which can compensate for DER's fault current contribution, may be needed to maintain proper fault detection time and protective relaying coordination intervals acceptable to the Area EPS operator.

NOTE 2—The presence of a ground source within the Local EPS can pose a back-feed risk to the distribution system even when the DER is otherwise disconnected.

6.2.2 Open phase conditions

The DER shall detect and *cease to energize* and *trip* all phases to which the DER is connected for any open phase condition occurring directly at the reference point of applicability per [4.2](#) and the *applicable voltages* per [4.3](#). The DER shall *cease to energize* and *trip* within 2.0 s of the open phase condition.

6.3 Area EPS reclosing coordination

Appropriate means shall be implemented to help ensure that Area EPS automatic reclosing onto a circuit remaining energized by the DER does not expose the Area EPS to unacceptable stresses or disturbances due to differences in instantaneous voltage, phase angle, or frequency between the separated systems at the instant of the reclosure (e.g., out-of-phase reclosing).⁷⁶

Operation in *momentary cessation* operating mode meets this *cease to energize* requirement. *Restore output* behavior shall be coordinated with Area EPS reclosing timing.

⁷³ Examples of non-compliant decrease of active power availability are loss of control power to the power conversion device or prime mover, or loss of auxiliary power.

⁷⁴ For example, voltage or frequency magnitude, time duration, droop, deadband.

⁷⁵ The Area EPS Operator may elect to use sequential tripping for the smaller DER with relatively low impact and allow the DER to *cease to energize* after the protective device on the Area EPS opened.

⁷⁶ Appropriate means may include, for example, Area EPS measures to block reclosing if the circuit remains energized, or existence of low DER penetration and DER technology-types such that energization would not be maintained for as long as the time of reclosing, or means to cease energization by DER when the Area EPS is isolated (e.g., transfer trip, or reliance on islanding detection requirements as specified in [8.1](#)).

In addition to these requirements, the requirements from 4.10 shall be considered. Voltage ride-through requirements for consecutive temporary voltage disturbances caused by a reclosing sequence are specified by 6.4.2.5.

6.4 Voltage

6.4.1 Mandatory voltage tripping requirements

When any *applicable voltage* is less than an undervoltage threshold, or greater than an overvoltage threshold, as defined in this subclause, the DER shall *cease to energize* the Area EPS and trip within the respective *clearing time* as indicated.⁷⁷ Under and overvoltage tripping thresholds and *clearing times* shall be adjustable over the *ranges of allowable settings* specified in Table 11 for *abnormal operating performance* Category I, Table 12 for Category II, or Table 13 for Category III. Unless specified otherwise by the Area EPS operator, default settings shall be used.

The voltage and time set points shall be field adjustable and may be remotely adjustable per the interoperability requirements specified in Clause 10.

The *ranges of allowable settings* do not mandate a requirement for the DER to ride through this magnitude and duration of abnormal voltage condition. The Area EPS operator may specify the voltage thresholds and maximum *clearing times* within the *ranges of allowable settings*; settings outside of these ranges shall only be allowed as necessary for DER equipment protection and shall not conflict with the voltage disturbance ride through requirements specified in 6.4.2.

Two overvoltage trip functions, OV1 and OV2, and two undervoltage trip functions, UV1 and UV2 apply simultaneously to DER of Category I, Category II, and Category III. For the overvoltage (OV) and undervoltage (UV) trip functions *clearing time* ranges and for the OV trip functions voltage ranges, the lower value is a limiting requirement (the setting shall not be set to lower values) and the upper value is a minimum requirement (the setting may be set above this value). For the UV trip functions voltage ranges, the upper value is a limiting requirement (the setting shall not be set to greater values) and the lower value is a minimum requirement (the setting may be set to lower values).⁷⁸ Area EPS operators may specify values within the specified range subject to the limitations on voltage trip settings specified by the *regional reliability coordinator*.^{79, 80}

⁷⁷ When *clearing times* are less than 0.16 seconds greater than the specified *clearing time*, the provisions of 4.7 item b)1) are applicable.

⁷⁸ The following are recommendations for hardware design of equipment used to implement the trip functions by use of fixed 'ranges of adjustability': For the overvoltage (OV) and undervoltage (UV) trip functions *clearing time* ranges and for the OV trip functions voltage ranges, the lower value should be a limiting design requirement (the range of adjustability should not extend to lower values) and the upper value should be a minimum design requirement (the range of adjustability may be extended above this value). For the UV trip functions voltage ranges, the upper value should be a limiting design requirement (the range of adjustability should not extend to greater values) and the lower value should be a minimum design requirement (the range of adjustability may be extended to lower values).

⁷⁹ In North America, the limitations for transmission-connected resources as specified in NERC PRC-024-2 [B27] may be used for reference.

⁸⁰ The lower and upper values of the *ranges of allowable settings* for voltage and frequency trip settings specified in this standard for DER are not intended to limit the capabilities and settings of other equipment on the Area EPS. It is recommended that settings applied on Area EPS equipment conform to the voltage and frequency ride-through objectives of this standard whenever the Area EPS is in normal configuration. However, it is recognized that in certain cases Area EPS operators may need to occasionally and selectively use trip settings outside the *ranges of allowable settings* to accommodate worker safety practices or to safeguard distribution infrastructure while in an abnormal configuration, e.g., during automatic reconfiguration of a circuit section or temporary loss of direct transfer trip of mid- and large-scale DER. Area EPS operators should limit trip settings on Area EPS equipment that conflict with this standard to only affect those selective DER and Area EPS equipment and only for a limited period necessary to meet these worker safety and equipment protection goals. Area EPS operators should coordinate these practices with the *regional reliability coordinator* who may consider *bulk power system* impacts of affected aggregate DER capacity.

Table 11—DER response (shall trip) to abnormal voltages for DER of abnormal operating performance Category I (see Figure H.7)

Shall trip—Category I				
Shall trip function	Default settings ^a		Ranges of allowable settings ^b	
	Voltage (p.u. of nominal voltage)	Clearing time (s)	Voltage (p.u. of nominal voltage)	Clearing time (s)
OV2	1.20	0.16	fixed at 1.20	fixed at 0.16
OV1	1.10	2.0	1.10–1.20	1.0–13.0
UV1	0.70	2.0	0.0–0.88	2.0–21.0
UV2	0.45	0.16	0.0–0.50	0.16–2.0

^aThe Area EPS operator may specify other voltage and *clearing time* trip settings within the *range of allowable settings*, e.g., to consider Area EPS protection coordination.

^bNominal system voltages stated in ANSI C84.1, Table 1 or as otherwise defined by the Area EPS operator. The *ranges of allowable settings* do not mandate a requirement for the DER to ride through this magnitude and duration of abnormal voltage condition. The Area EPS operator may specify the voltage thresholds and maximum *clearing times* within the *ranges of allowable settings*; settings outside of these ranges shall only be allowed as necessary for DER equipment protection and shall not conflict with the voltage disturbance ride through requirements specified in 6.4.2. For the overvoltage (OV) and undervoltage (UV) trip functions *clearing time* ranges and for the OV trip functions voltage ranges, the lower value is a limiting requirement (the setting shall not be set to lower values) and the upper value is a minimum requirement (the setting may be set above this value). For the UV trip functions voltage ranges, the upper value is a limiting requirement (the setting shall not be set to greater values) and the lower value is a minimum requirement (the setting may be set to lower values).

Table 12—DER response (shall trip) to abnormal voltages for DER of abnormal operating performance Category II (see Figure H.8)

Shall trip—Category II				
Shall trip function	Default settings ^a		Ranges of allowable settings ^b	
	Voltage (p.u. of nominal voltage)	Clearing time (s)	Voltage (p.u. of nominal voltage)	Clearing time (s)
OV2	1.20	0.16	fixed at 1.20	fixed at 0.16
OV1	1.10	2.0	1.10–1.20	1.0–13.0
UV1	0.70	10.0	0.0–0.88	2.0–21.0
UV2	0.45	0.16	0.0–0.50	0.16–2.0

^aThe Area EPS operator may specify other voltage and *clearing time* trip settings within the *range of allowable settings*, e.g., to consider Area EPS protection coordination.

^bNominal system voltages stated in ANSI C84.1, Table 1 or as otherwise defined by the Area EPS operator. The *ranges of allowable settings* do not mandate a requirement for the DER to ride through this magnitude and duration of abnormal voltage condition. The Area EPS operator may specify the voltage thresholds and maximum *clearing times* within the *ranges of allowable settings*; settings outside of these ranges shall only be allowed as necessary for DER equipment protection and shall not conflict with the voltage disturbance ride through requirements specified in 6.4.2. For the overvoltage (OV) and undervoltage (UV) trip functions *clearing time* ranges and for the OV trip functions voltage ranges, the lower value is a limiting requirement (the setting shall not be set to lower values) and the upper value is a minimum requirement (the setting may be set above this value). For the UV trip functions voltage ranges, the upper value is a limiting requirement (the setting shall not be set to greater values) and the lower value is a minimum requirement (the setting may be set to lower values).

Table 13—DER response (shall trip) to abnormal voltages for DER of abnormal operating performance Category III (see Figure H.9)

Shall trip—Category III				
Shall trip function	Default settings ^a		Ranges of allowable settings ^b	
	Voltage (p.u. of nominal voltage)	Clearing time (s)	Voltage (p.u. of nominal voltage)	Clearing time (s)
OV2	1.20	0.16	fixed at 1.20	fixed at 0.16
OV1	1.10	13.0	1.10–1.20	1.0–13.0
UV1	0.88	21.0	0.0–0.88	21.0–50.0
UV2	0.50	2.0	0.0–0.50	2.0–21.0

^aThe Area EPS operator may specify other voltage and *clearing time* trip settings within the *range of allowable settings*, e.g., to consider Area EPS protection coordination.

^bNominal system voltages stated in ANSI C84.1, Table 1 or as otherwise defined by the Area EPS operator. The *ranges of allowable settings* do not mandate a requirement for the DER to ride through this magnitude and duration of abnormal voltage condition. The Area EPS operator may specify the voltage thresholds and maximum *clearing times* within the *ranges of allowable settings*; settings outside of these ranges shall only be allowed as necessary for DER equipment protection and shall not conflict with the voltage disturbance ride-through requirements specified in 6.4.2. For the overvoltage (OV) and undervoltage (UV) trip functions *clearing time* ranges and for the OV trip functions voltage ranges, the lower value is a limiting requirement (the setting shall not be set to lower values) and the upper value is a minimum requirement (the setting may be set above this value). For the UV trip functions voltage ranges, the upper value is a limiting requirement (the setting shall not be set to greater values) and the lower value is a minimum requirement (the setting may be set to lower values).

6.4.2 Voltage disturbance ride-through requirements

6.4.2.1 General requirements and exceptions

The performance required of DER during voltage disturbances is specified in this clause. DER shall meet either the *abnormal operating performance* Category I, Category II, or Category III requirements of this clause, as specified by the Area EPS operator. The voltage disturbance ride-through requirements specified in this clause do not apply when frequency is outside of the ride-through range specified in 6.5.2.

DER shall be designed to provide the voltage disturbance ride-through capability specified in this clause without exceeding DER capabilities. Any tripping of the DER, or other failure to provide the specified ride-through capability, due to DER self-protection as a direct or indirect result of a voltage disturbance within a ride-through region, shall constitute non-compliance with this standard.

The DER shall specify its *abnormal operating performance category* within the nameplate information.

The voltage disturbance ride-through specified in the remainder of 6.4.2 shall not apply and DER may *cease to energize* the Area EPS and trip without limitations if any of the following applies:

- a) The net active power exported across the *point of common coupling* into the Area EPS is continuously maintained at a value less than 10% of the aggregate rating of DER connected to the Local EPS prior to any voltage disturbance, and the Local EPS disconnects from the Area EPS, along with Local EPS load to intentionally form a Local EPS island, or
- b) An active power demand of the Local EPS load equal or greater than 90% of the pre-disturbance aggregate DER active power output is shed within 0.1 s of when the DER ceases to energize the Area EPS and trips.

For voltage disturbances where the *applicable voltage* is outside the *ride-through operating region* parameters (voltage range and corresponding cumulative duration, minimum time) specified in Table 14 for *abnormal operating performance* Category I, Table 15 for Category II, or Table 16 for Category III,

requirements for continued operation (ride-through), or *restore output* subsequent to the voltage disturbance, shall not apply.⁸¹

Table 14—Voltage ride-through requirements for DER for abnormal operating performance Category I (see Figure H.7)

Voltage range (p.u.)	Operating mode/response	Minimum ride-through time (s) (design criteria)	Maximum response time (s) (design criteria)
$V > 1.20$	Cease to Energize ^a	N/A	0.16
$1.175 < V \leq 1.20$	Permissive Operation	0.2	N/A
$1.15 < V \leq 1.175$	Permissive Operation	0.5	N/A
$1.10 < V \leq 1.15$	Permissive Operation	1	N/A
$0.88 \leq V \leq 1.10$	Continuous Operation	Infinite	N/A
$0.70 \leq V < 0.88$	Mandatory Operation	Linear slope of 4 s/1 p.u. voltage starting at 0.7 s @ 0.7 p.u.: $T_{VRT} = 0.7 \text{ s} + \frac{4 \text{ s}}{1 \text{ p.u.}}(V - 0.7 \text{ p.u.})$	N/A
$0.50 \leq V < 0.70$	Permissive Operation	0.16	N/A
$V < 0.50$	Cease to Energize ^a	N/A	0.16

^aCessation of current exchange of DER with Area EPS in not more than the maximum specified time and with no intentional delay. This does not necessarily imply disconnection, isolation, or a trip of the DER. This may include momentary cessation or trip.

Table 15—Voltage ride-through requirements for DER of abnormal operating performance Category II (see Figure H.8)

Voltage range (p.u.)	Operating mode/response	Minimum ride-through time (s) (design criteria)	Maximum response time (s) (design criteria)
$V > 1.20$	Cease to Energize ^a	N/A	0.16
$1.175 < V \leq 1.20$	Permissive Operation	0.2	N/A
$1.15 < V \leq 1.175$	Permissive Operation	0.5	N/A
$1.10 < V \leq 1.15$	Permissive Operation	1	N/A
$0.88 \leq V \leq 1.10$	Continuous Operation	Infinite	N/A
$0.65 \leq V < 0.88$	Mandatory Operation	Linear slope of 8.7 s/1 p.u. voltage starting at 3 s @ 0.65 p.u.: $T_{VRT} = 3 \text{ s} + \frac{8.7 \text{ s}}{1 \text{ p.u.}}(V - 0.65 \text{ p.u.})$	N/A
$0.45 \leq V < 0.65$	Permissive Operation	0.32	N/A
$0.30 \leq V < 0.45$	Permissive Operation	0.16	N/A
$V < 0.30$	Cease to Energize ^a	N/A	0.16

^aCessation of current exchange of DER with Area EPS in not more than the maximum specified time and with no intentional delay. This does not necessarily imply disconnection, isolation, or a trip of the DER. This may include momentary cessation or trip.

⁸¹ Overvoltage and undervoltage events usually occur independently from each other, but may also be initiated by the same event (e.g., after clearing a fault, there may be an overvoltage event due to electromagnetic transients or system dynamic response). Thus, the high-voltage ride-through and the low-voltage ride-through requirements are based on cumulative durations and have to be interpreted independently from each other.

Table 16—Voltage ride-through requirements for DER of abnormal operating performance Category III (see Figure H.9)

Voltage range (p.u.)	Operating mode/response	Minimum ride-through time (s) (design criteria)	Maximum response time (s) (design criteria)
$V > 1.20$	Cease to Energize ^a	N/A	0.16
$1.10 < V \leq 1.20$	Momentary Cessation ^b	12	0.083
$0.88 \leq V \leq 1.10$	Continuous Operation	Infinite	N/A
$0.70 \leq V < 0.88$	Mandatory Operation	20	N/A
$0.50^c \leq V < 0.70$	Mandatory Operation	10	N/A
$V < 0.50^c$	Momentary Cessation ^b	1	0.083

^aCessation of current exchange of DER with Area EPS in not more than the maximum specified time and with no intentional delay. This does not necessarily imply disconnection, isolation, or a trip of the DER. This may include momentary cessation or trip.

^bTemporarily cease to energize an EPS, while connected to the Area EPS, in response to a disturbance of the applicable voltages or the system frequency, with the capability of immediate restore output of operation when the applicable voltages and the system frequency return to within defined ranges.

^cThe voltage threshold between mandatory operation and momentary operation may be changed by mutual agreement between the Area EPS operator and DER operator, for example to allow the DER to provide Dynamic Voltage Support below 0.5 p.u.

6.4.2.2 Voltage disturbances within continuous operation region

Voltage disturbances of any duration, for which the *applicable voltage* as specified in 4.3 remains within Range B as defined by ANSI C84.1, shall not cause the DER to *cease to energize* and trip from the Area EPS. The DER shall remain in operation during any such disturbance, and shall continue to deliver *available active power* of magnitude at least as great as its pre-disturbance level of active power, prorated by the per-unit voltage level of the least phase voltage if that voltage is less than the nominal voltage.⁸² Temporary deviations of active power having durations not exceeding 0.5 s shall be allowed.

*Exception: Three-phase DER may cease to energize and trip if the negative sequence component of the applicable voltage is greater than 5% of the nominal voltage for greater than 60 s or greater than 3% of the nominal voltage for greater than 300 s, provided that the voltage imbalance is neither caused nor aggravated by unbalanced currents of the Local EPS.*⁸³

6.4.2.3 Low-voltage ride-through

6.4.2.3.1 General

For low-voltage ride-through, the relevant voltage at any given time shall be the least magnitude of the individual applicable phase-to-neutral, phase-to-ground, or phase-to-phase voltage relative to the corresponding nominal system voltage as specified in 4.3.

⁸² Changes of active power are permitted in response to control commands in accordance with 4.6 or in response to other control settings.

⁸³ It should be noted that the equipment design requirements for continuous and short-time negative sequence current capabilities specified in IEEE Std C50.12 and IEEE Std C50.13 may not be sufficient for round rotor synchronous generators with ratings 10 MVA and larger or salient pole synchronous generators with ratings 5 MVA and larger to operate reliably in unbalanced *applicable voltage* conditions that may regularly occur in Area EPS governed by this standard. Note in 1.4 that this standard as a whole is not intended for, and is in part inappropriate for, application to energy resources connected to transmission or networked sub-transmission systems and that for DER interconnections that include individual synchronous generator units rated 10 MVA and greater, and where the requirements of this standard conflict with the requirements of IEEE Std C50.12 or IEEE Std C50.13, the requirements of IEEE Std C50.12 or IEEE Std C50.13, as relevant to the type of synchronous generator used, shall prevail.

6.4.2.3.2 Low-voltage ride-through capability

During temporary voltage disturbances, for which the *applicable voltage* on the phase that has the least voltage magnitude is less than the minimum of the *continuous operation region*, and within the corresponding voltage ranges and cumulative duration (minimum time) specified in Table 14 for Category I, Table 15 for Category II, and Table 16 for Category III, the DER shall be capable to ride-through and

- Shall maintain synchronism with the Area EPS.⁸⁴
- Shall not *trip*.
- Shall restore output as specified in 6.4.2.7.

6.4.2.3.3 Low-voltage ride-through performance

During low-voltage ride-through, the DER shall operate in the following operating modes as specified in Table 14 for Category I, Table 15 for Category II, and Table 16 for Category III with the following requirements:

During temporary voltage disturbances, for which the *applicable voltage* on the phase that has the least voltage magnitude is within the *mandatory operation region*, the DER

- Shall maintain synchronism with the Area EPS.
- Shall continue to exchange current with the Area EPS.
- Shall neither *cease to energize* nor *trip*.

DER of Category II and Category III shall, by default, not reduce its total apparent current during the disturbance period in *mandatory operation mode* below 80% of the pre-disturbance value or of the corresponding active current level subject to the available active power, whichever is less, subject to the following:

- Active and reactive current oscillations that are positively damped are permitted during the disturbance and post-disturbance period.
- Transient apparent current magnitude changes having duration less than 30 ms, and dynamic current magnitude oscillations for which the mean value is greater than or equal to the pre-disturbance value constitute exceptions to this requirement.

By mutual agreement between the Area EPS operator and DER operator, other current characteristics may be specified.⁸⁵

During temporary voltage disturbances, for which the *applicable voltage* on the phase that has the least voltage magnitude is within the *permissive operation region*, the DER

- Shall maintain synchronism with the Area EPS or shall not *trip*.
- May continue to exchange current with the Area EPS or may *cease to energize*.

⁸⁴ For all DER: maintain functioning of auxiliary equipment. For synchronous generation-based DER: maintain transient stability. For inverter-based DER: maintain “Current Angle Stability.” “Current Angle Stability” is the ability of a DER, which is grid-interfaced via a voltage source converter (VSC) and operated in parallel to the grid to inject current (magnitude, angle) for transiently changing grid conditions without violating the VSC synchronization methods’ stability zone.

⁸⁵ For example, dynamic voltage support as specified in 6.4.2.6 may be used within the *mandatory operating region*.

- If DER ceases to energize, shall restore output as specified in 6.4.2.7.

For Category III DER, during temporary voltage disturbances, for which the *applicable voltage* on the phase that has the least voltage magnitude is within the *momentary cessation operation region*, the DER

- Shall not *trip*.
- Shall *cease to energize*.
- Shall restore output as specified in 6.4.2.7.

6.4.2.4 High-voltage ride-through

6.4.2.4.1 General

For high-voltage ride-through, the relevant voltage at any given time shall be the greatest magnitude of the individual applicable phase-to-neutral, phase-to-ground or phase-to-phase voltage relative to the corresponding nominal system voltage as specified in 4.3.

6.4.2.4.2 High-voltage ride-through capability

During temporary voltage disturbances, for which the *applicable voltage* on the phase having the greatest voltage magnitude is greater than the maximum of the *continuous operation region*, and within the corresponding voltage ranges and cumulative duration (minimum time) specified in Table 14 for *abnormal operating performance* Category I, Table 15 for Category II, or Table 16 for Category III, the DER shall be capable to ride-through and

- Shall maintain synchronism with the Area EPS.⁸⁶
- Shall not *trip*.
- Shall restore output as specified in 6.4.2.7.

6.4.2.4.3 High-voltage ride-through performance

During high-voltage ride-through, the DER shall operate in the following operating modes as specified in Table 14 for *abnormal operating performance* Category I, Table 15 for Category II, and Table 16 for Category III with the following requirements:

During temporary voltage disturbances, for which the *applicable voltage* on the phase having the greatest voltage magnitude is within the *permissive operating region*, the DER

- Shall maintain synchronism with the Area EPS or shall not *trip*.
- May continue to exchange current with the Area EPS or may *cease to energize*.
- If DER ceases to energize, shall restore output as specified in 6.4.2.7.

⁸⁶ For synchronous generation-based DER, maintain transient stability. For inverter-based DER, maintain control stability or “current angle stability.” For all DER, maintain functioning of auxiliary equipment.

For Category III DER, during temporary voltage disturbances, for which the *applicable voltage* on the phase having the greatest voltage magnitude is within the *momentary cessation operation region*, the DER

- Shall not *trip*.
- Shall *cease to energize*.
- Shall restore output as specified in 6.4.2.7.

6.4.2.5 Ride-through of consecutive voltage disturbances⁸⁷

The requirements for continued operation (ride-through), or *restore output* shall apply to multiple consecutive voltage disturbances within a *ride-through operating region*, for which the voltage range and corresponding cumulative durations are specified in Table 14 for *abnormal operating performance* Category I, Table 15 for Category II, and Table 16 for Category III. These requirements are subject to the following provisions that specify conditions in Table 17 for which a DER may trip:⁸⁸

- a) For a set of consecutive disturbances in which voltages fall within a *ride-through operating region* multiple times, each interspersed by a period of voltage within the *continuous operation region* that has a duration no greater than specified in Table 17 Column 3 for the respective *performance category*, the cumulative duration of voltage within the respective *ride-through operating region* for all such disturbances shall be compared with the maximum required duration for the respective voltage disturbance severity. If this cumulative duration exceeds the required duration, the DER may trip.
- b) If voltages remain entirely within the *continuous operation region* for a time period greater than specified in Table 17, Column 3 for the respective *performance category*, any further disturbance shall be considered as a new set of disturbances, and a new accumulation of ride-through duration as defined in item a) shall apply.
- c) The DER shall not be required to ride through any more ride-through disturbance sets than the maximum number given in Table 17, Column 2 within the time period specified in Table 17, Column 4. Once a period-of-time as given in Table 17, Column 4 has passed since the last disturbance, the DER shall be required to ride through any new sets of disturbances as specified in item a) and item b).

*Exception: DER shall be allowed to trip if the timing of multiple consecutive voltage disturbances during a specific event stimulate electromechanical oscillations to the degree where DER synchronism is lost or potential damage to the DER may occur.*⁸⁹

⁸⁷The primary intent of voltage ride-through requirements for consecutive voltage disturbances is for DER to ride through a reasonable tripping and reclosing sequence associated with a short-circuit fault on a different portion of the Area EPS than that to which it is connected, but which causes these voltage disturbances at the DER. Other causes for consecutive disturbances are separate faults that might occur in a severe storm, or dynamic voltage swings that cyclically transition in and out of the *continuous operation region*.

⁸⁸None of these provisions specifies that a DER shall trip for consecutive voltage disturbances. These provisions only specify conditions for which a DER may trip and is relieved of the mandatory requirement to ride through voltage disturbances. The ride-through of a DER for more than the specified number of disturbance sets (Column 2), for disturbance sets that are separated by less than the specified minimum time (Column 3), and disturbance sets occurring more frequently than the specified time window for new count (Column 4) does not pose a risk to the Area EPS, and DER should ride through as many disturbance sets as they are capable.

⁸⁹It should be noted that IEEE Std C50.13 provides assessment criteria for a site-specific study of torsional stress for synchronous generators with ratings 10 MVA and larger. Per 1.4, this standard as a whole is not intended for, and is in part inappropriate for, application to energy resources connected to transmission or networked sub-transmission systems and for DER interconnections that include individual synchronous generator units rated 10 MVA and greater, and where the requirements of this standard conflict with the requirements of IEEE Std C50.12 or IEEE Std C50.13, the requirements of IEEE Std C50.12 or IEEE Std C50.13, as relevant to the type of synchronous generator used, shall prevail.

Table 17 —Voltage ride-through requirements for consecutive temporary voltage disturbances caused by unsuccessful reclosing for DER of abnormal operating performance Category I, Category II, and Category III

Col. 1	Col. 2	Col. 3	Col. 4
Category	Maximum number of ride-through disturbance sets	Minimum time between successive disturbance sets (s)	Time window for new count of disturbance sets (min)
I	2	20.0	60
II	2	10.0	60
III	3	5.0	20

6.4.2.6 Dynamic voltage support

Dynamic voltage support⁹⁰ from DER can support the *applicable voltage* by supplying the Area EPS with a current⁹¹ during low-voltage ride-through and high-voltage ride-through operation. Alternate means of DER control and designs can exist to provide dynamic voltage support. Support of the *applicable voltage* can provide benefits to the Area EPS and BPS.

6.4.2.6.1 Dynamic voltage support capability

Any DER may have the capability of *dynamic voltage support* during low-voltage ride-through and high-voltage ride-through.

6.4.2.6.2 Dynamic voltage support performance

The *dynamic voltage support* capability may be utilized during *mandatory operation* or *permissive operation* under a mutual agreement with the Area EPS operator⁹² considering both the capability and the DER-specific implementation of the dynamic voltage support function. The DER shall maintain synchronism with the Area EPS and may provide *dynamic voltage support* to the Area EPS during and following temporary voltage disturbances, for which the *applicable voltage* on any phase is as follows:

- a) Less than the minimum of the *continuous operation* region and within either the *mandatory operation* or the *permissive operation* region, or
- b) Greater than the maximum of the *continuous operation* region and within the *permissive operation* region.

The *dynamic voltage support* shall not cause the DER to *cease to energize* in situations where the DER would not *cease to energize* without the *dynamic voltage support*.⁹³

⁹⁰ *Dynamic voltage support* provides rapid reactive power exchanges during voltage excursions. *Dynamic voltage support* may provide better voltage stability in the distribution system during transient events extending into voltage ride-through or high-voltage ride-through regions. Valuable information on the preferable characteristics of current injected to the Area EPS as dynamic voltage support is provided in Boemer [B3].

⁹¹ The relative effectiveness active and reactive current of the dynamic voltage support can depend on the *X/R* ratio of the Area EPS.

⁹² The Area EPS operator may consider the impact of a *dynamic voltage support* from DER on the Area EPS protection.

⁹³ The implementation (design, testing and conformance, communications, etc.) of the *dynamic voltage support* is recommended to have adequate capability to prevent the creation of overvoltage in any phases of the *applicable voltages* when providing *dynamic voltage support* for any types of faults (balanced and unbalanced), for which the overvoltage would not occur without the DER.

6.4.2.7 Restore output with voltage ride-through

6.4.2.7.1 Restore output without dynamic voltage support

If the DER rides through a voltage disturbance without trip and the DER does not provide *dynamic voltage support* (see 6.4.2.6) while in a *mandatory operation* or *permissive operation* region, once the *applicable voltage* surpasses the lower value of the *mandatory operation* region during low-voltage ride-through or the *applicable voltage* returns below the upper value of the *continuous operation* region during high-voltage ride-through, the DER

- Shall maintain synchronism with the Area EPS.
- Shall *restore output* of active current to at least 80% of pre-disturbance active current level within 0.4 s. Active and reactive current oscillations in the post-disturbance period that are positively damped are acceptable.

6.4.2.7.2 Restore output with dynamic voltage support

If the DER rides through a voltage disturbance without trip and the DER provides *dynamic voltage support* while in a *mandatory operation* or *permissive operation* region, once the *applicable voltage* enters the *continuous operation region*, the DER

- Shall maintain synchronism with the Area EPS.
- Shall continue to provide *dynamic voltage support* up to 5 s after the *applicable voltage* surpasses the lower value of the *continuous operation region* and *restore output* of active current to at least 80% of pre-disturbance active current level or to the available active current subject to reactive current priority, whichever is less, within 0.4 s.
- Shall discontinue providing *dynamic voltage support* 5 s after the *applicable voltage* surpasses the lower value of the continuous operation region and resume reactive power functionality for normal conditions as defined in 4.2 for the mode that has been selected.

6.4.2.7.3 Transition between performance operating regions for Category III DER

If the RPA of a Category III DER is the PCC, the requirement for transitioning between *momentary cessation* and *mandatory operation* or *momentary cessation* and *continuous operation*, may optionally be based on the voltage measured at the PoC. When this optionality is exercised, the *momentary cessation* threshold shall be adjusted⁹⁴ for the predicted voltage difference between the PCC and PoC, such that the performance of the DER approximates the defined performance based on PCC voltage. This option does not apply to Category I and Category II DER.⁹⁵

⁹⁴ The capability to adjust the momentary cessation threshold may be mutually agreed upon between the Area EPS Operator in coordination with the *regional reliability coordinator* and the DER Operator and may otherwise be exempt from the interoperability management information requirements in 10.6.

⁹⁵ Because Category I and Category II have permissive operating regions at voltages somewhat less than the lower limit of the *mandatory operation region*, this option is not necessary.

6.5 Frequency

6.5.1 Mandatory frequency tripping requirements

When the system frequency is in a range given in Table 18, and the fundamental-frequency component of voltage on any phase is greater than 30% of nominal, the DER shall *cease to energize* the Area EPS and *trip* within a *clearing time* as indicated.⁹⁶ Under and overfrequency tripping thresholds and *clearing times* shall be adjustable over the *ranges of allowable settings* specified in Table 18. The underfrequency and overfrequency trip settings shall be specified by the Area EPS operator in coordination with the requirements of the *regional reliability coordinator*. If the Area EPS operator does not specify any settings, the default settings shall be used.

The frequency and time set points shall be field adjustable and may be remotely adjustable per the interoperability requirements specified in Clause 10.

The *ranges of allowable settings* do not mandate a requirement for the DER to ride through this magnitude and duration of abnormal frequency condition. The Area EPS operator may specify the frequency thresholds and maximum *clearing times* within the *ranges of allowable settings*; settings outside of these ranges shall only be allowed as necessary for DER equipment protection and shall not conflict with the frequency disturbance ride-through requirements specified in 6.5.2.

Two overfrequency trip functions, OF1 and OF2, and two underfrequency trip functions, UF1 and UF2 apply simultaneously. For the overfrequency (OF) and underfrequency (UF) trip functions *clearing time* ranges and for the OF trip functions frequency ranges, the lower value is a limiting requirement (the setting shall not be set to lower values) and the upper value is a minimum requirement (the setting may be set above this value). For the UF trip functions frequency ranges, the upper value is a limiting requirement (the setting shall not be set to greater values) and the lower value is a minimum requirement (the setting may be set to lower values).⁹⁷ Area EPS operators may specify values within the specified range subject to the limitations on frequency trip settings specified by the *regional reliability coordinator*.^{98, 99}

⁹⁶ When *clearing times* are less than 0.16 seconds greater than the specified *clearing time*, the provisions of 4.7 b)1) are applicable.

⁹⁷ The following are recommendations for hardware design of equipment used to implement the trip functions by use of fixed 'ranges of adjustability': For the overfrequency (OF) and underfrequency (UF) trip functions *clearing time* ranges and for the OF trip functions frequency ranges, the lower value should be a limiting design requirement (the range of adjustability should not extend to lower values) and the upper value should be a minimum design requirement (the range of adjustability may be extended above this value). For the UF trip functions frequency ranges, the upper value should be a limiting design requirement (the range of adjustability should not extend to greater values) and the lower value should be a minimum design requirement (the range of adjustability may be extended to lower values).

⁹⁸ In North America, the limitations for transmission-connected resources as specified in NERC PRC-024-2 [B27] may be used for reference.

⁹⁹ The lower and upper values of the *ranges of allowable settings* for voltage and frequency trip settings specified in this standard for DER are not intended to limit the capabilities and settings of other equipment on the Area EPS. It is recommended that settings applied on Area EPS equipment conform to the voltage and frequency ride-through objectives of this standard whenever the Area EPS is in normal configuration. However, it is recognized that in certain cases Area EPS operators may need to occasionally and selectively use trip settings outside the *ranges of allowable settings* to accommodate worker safety practices or to safeguard distribution infrastructure while in an abnormal configuration, e.g., during automatic reconfiguration of a circuit section or temporary loss of direct transfer trip of mid- and large-scale DER. Area EPS operators should limit trip settings on Area EPS equipment that conflict with this standard to only affect those selective DER and Area EPS equipment and only for a limited period necessary to meet these worker safety and equipment protection goals. Area EPS operators should coordinate these practices with the *regional reliability coordinator* who may consider *bulk power system* impacts of affected aggregate DER capacity.

Table 18—DER response (shall trip) to abnormal frequencies for DER of abnormal operating performance Category I, Category II, and Category III (see Figure H.10)

Shall trip function	Default settings ^a		Ranges of allowable settings ^b	
	Frequency ^c (Hz)	Clearing time (s)	Frequency (Hz)	Clearing time (s)
OF2	62.0	0.16	61.8–66.0	0.16–1 000.0
OF1	61.2	300.0	61.0–66.0	180.0–1 000.0
UF1	58.5	300.0 ^c	50.0–59.0	180.0–1 000
UF2	56.5	0.16	50.0–57.0	0.16–1 000

^aThe frequency and *clearing time* set points shall be field adjustable. The actual applied underfrequency (UF) and overfrequency (OF) trip settings shall be specified by the Area EPS operator in coordination with the requirements of the *regional reliability coordinator*. If the Area EPS operator does not specify any settings, the default settings shall be used.

^bThe *ranges of allowable settings* do not mandate a requirement for the DER to ride through this magnitude and duration of abnormal frequency condition. The Area EPS operator may specify the frequency thresholds and maximum *clearing times* within the *ranges of allowable settings*; settings outside of these ranges shall only be allowed as necessary for DER equipment protection and shall not conflict with the frequency disturbance ride through requirements specified in 6.5.2. For the overfrequency (OF) and underfrequency (UF) trip functions *clearing time* ranges and for the OF trip functions frequency ranges, the lower value is a limiting requirement (the setting shall not be set to lower values) and the upper value is a minimum requirement (the setting may be set above this value). For the UF trip functions frequency ranges, the upper value is a limiting requirement (the setting shall not be set to greater values) and the lower value is a minimum requirement (the setting may be set to lower values).

^cThis time shall be chosen to coordinate with typical regional underfrequency load shedding programs and expected frequency restoration time.

6.5.2 Frequency disturbance ride-through requirements

6.5.2.1 General requirements and exceptions

The performance required of DER during frequency disturbances is specified in this clause. DER shall meet one of the *abnormal operating performance* Category I, Category II, or Category III of this clause. The frequency disturbance ride-through requirements specified in this clause do not apply when voltage is outside of the ride-through range specified in 6.4.2.

DER shall be designed to provide the frequency disturbance ride-through capability specified in this clause without exceeding DER capabilities. Any tripping of the DER, or other failure to provide the specified ride-through capability, due to DER self-protection as a direct or indirect result of a frequency disturbance within a ride-through region, shall constitute non-compliance with this standard.

The DER shall specify its *abnormal operating performance category* within the nameplate information.

The frequency disturbance ride-through specified in the remainder of 6.5.2 shall not apply and DER may *cease to energize* the Area EPS and trip without limitations if any of the following applies:

- a) The net active power exported¹⁰⁰ across the *point of common coupling* into the Area EPS is continuously maintained at a value less than 10% of the aggregate rating of DER connected to the Local EPS prior to any frequency disturbance, and the Local EPS disconnects from the Area EPS, along with Local EPS load to intentionally form a Local EPS island, or

¹⁰⁰ Energy Storage DER operating in a manner that modulates active power, i.e., importing and exporting active power, shall be evaluated for this exception based solely on the maximum positive power point over the modulated power range.

- b) An active power demand of the Local EPS load equal or greater than 90% of the pre-disturbance aggregate DER active power output is shed within 0.1 s of when the DER ceases to energize the Area EPS and trips.

For frequency disturbances outside the ride-through operating region parameters (frequency range and corresponding cumulative duration, minimum time) specified in Table 19 for Category I, Category II, and Category III, requirements for continued operation (ride-through), or *restore output* subsequent to the frequency disturbance, shall not apply.¹⁰¹

Table 19—Frequency ride-through requirements for DER of abnormal operating performance Category I, Category II, and Category III (see Figure H.10)

Frequency range (Hz)	Operating mode	Minimum time (s) (design criteria)
$f > 62.0$	No ride-through requirements apply to this range	
$61.2 < f \leq 61.8$	Mandatory Operation ^a	299
$58.8 \leq f \leq 61.2$	Continuous Operation ^{a,b}	Infinite ^c
$57.0 \leq f < 58.8$	Mandatory Operation ^b	299
$f < 57.0$	No ride-through requirements apply to this range	

^aAny DER shall provide the frequency-droop (frequency-power) operation for high-frequency conditions specified in 6.5.2.7.

^bDER of Category I may provide the frequency-droop (frequency-power) operation for low-frequency conditions specified in 6.5.2.7. DER of Category II or Category III shall provide the frequency-droop (frequency-power) operation for low-frequency conditions specified in 6.5.2.7.

^cFor a per-unit ratio of Voltage/frequency limit of $V/f \leq 1.1$.

6.5.2.2 Frequency disturbances within continuous operation region

Frequency disturbances of any duration, for which the system frequency remains between 58.8 Hz and 61.2 Hz and the per-unit ratio of Voltage/frequency is less than or equal to 1.1, shall not cause the DER to trip. The DER shall remain in operation during any such disturbance, and shall be able to continue to exchange active power at least as great as its pre-disturbance level of power.

6.5.2.3 Low-frequency ride-through

6.5.2.3.1 Low-frequency ride-through capability

During temporary frequency disturbances, for which the system frequency is less than 58.8 Hz and greater than or equal to 57.0 Hz, and having a cumulative duration below 58.8 Hz of less than 299 s in any ten-minute period, the DER shall be capable to ride-through and

- Shall maintain synchronism with the Area EPS.
- Shall not reduce its active power output below the value specified in Table 20, depending on the DER *performance category* as described in Clause 4. Reductions of *available active power* due to the underfrequency event shall not be allowed when the voltage is within the continuous operating range. Active power may be reduced in proportion with the grid voltage when the grid voltage is below the level for *continuous operation*.

¹⁰¹ This standard may be adopted by AGIRs with frequency values defining frequency ride-through performance in the *continuous operation* region and *mandatory operation* region other than the ones specified.

Table 20—Frequency ride-through requirements for active power output capability for abnormal operating performance Category I, Category II, and Category III

Category	Active power output capability
I	80% of nameplate active power rating or the pre-disturbance active power output whichever is less
II and III	Pre-disturbance active power output
NOTE—Per 6.1, this requirement is limited to <i>available active power</i> .	

6.5.2.3.2 Low-frequency ride-through performance

During low-frequency ride-through, the DER shall operate in the *mandatory operation* region as specified in Table 19 for *abnormal operating performance* Category I, Category II, and Category III with the following requirements:

During temporary frequency disturbances, for which the system frequency is within the *mandatory operation* region, the DER

- Shall maintain synchronism with the Area EPS.
- Shall continue to exchange pre-disturbance current with the Area EPS subject to limitations specified in Table 20 and shall neither *cease to energize* nor *trip*. Active and reactive current oscillations that are positively damped are acceptable.
- Shall, as applicable, modulate active power to mitigate the underfrequency conditions as specified in Table 22, depending on the DER *performance category* as described in Clause 4. Neither provision of energy storage capability, nor operation of DER at power outputs less than the power available in order to allow reserve for power increase in response to underfrequency (pre-curtailment), are requirements of this standard.¹⁰²

6.5.2.4 High-frequency ride-through

6.5.2.4.1 High-frequency ride-through capability

During temporary frequency disturbances, for which the system frequency is greater than 61.2 Hz and less than or equal to 61.8 Hz, and having a cumulative duration greater than 61.2 Hz of less than 299 s in any ten-minute period, the DER shall be capable to ride-through and shall maintain synchronism with the Area EPS.

6.5.2.4.2 High-frequency ride-through performance

During high-frequency ride-through, the DER shall operate in *mandatory operation* region as specified in Table 19 for *abnormal operating performance* Category I, Category II, and Category III with the following requirements:

During temporary frequency disturbances, for which the system frequency is within the *mandatory operation* region, the DER

¹⁰² Pre-curtailment or other measures to provide frequency response reserve may be included in contractual agreements and interconnection agreements, which are outside the scope of this standard. The intent of the requirement in this standard is for the DER to only have the control capability in the DER to provide frequency response when the reserve exists, either due to specific contractual arrangements, dispatch control, or when curtailment exists for other reasons. Direction of active power can be negative (charging) for Energy Storage DER, e.g., return to frequency reduction via charging through droop or dispatch control, if operating for that purpose prior to trip.

- Shall maintain synchronism with the Area EPS.
- Shall continue to exchange current with the Area EPS and shall neither *cease to energize* nor *trip*.
- Shall modulate active power to mitigate the overfrequency conditions.

6.5.2.5 Rate of change of frequency (ROCOF) ride-through

Within the *continuous operation region* and the low-frequency and high-frequency ride-through operating regions (frequency range and corresponding cumulative duration, minimum time), the DER shall ride through and shall not trip for frequency excursions having magnitudes of rates of change of frequency (ROCOF) that are less than or equal to the values specified in Table 21 per *abnormal operating performance category*.¹⁰³ As specified in 4.3, the ROCOF shall be the average rate of change of frequency over an averaging window of at least 0.1 s.

Table 21 —Rate of change of frequency (ROCOF) ride-through requirements for DER of abnormal operating performance Category I, Category II, and Category III

Category I	Category II	Category III
0.5 Hz/s	2.0 Hz/s	3.0 Hz/s

6.5.2.6 Voltage phase angle changes ride-through

Multi-phase DER shall ride through for positive-sequence phase angle changes within a sub-cycle-to-cycle time frame of the *applicable voltage* of less than or equal to 20 electrical degrees. In addition, multi-phase DER shall remain in operation for change in the phases angle of individual phases less than 60 electrical degrees, provided that the positive sequence angle change does not exceed the forestated criterion. Single-phase DER shall remain in operation for phase angle changes within a sub-cycle-to-cycle time frame of the *applicable voltage* of less than or equal to 60 electrical degrees. Active and reactive current oscillations in the post-disturbance period that are positively damped or momentary cessation of the DER having a maximum duration of 0.5 s shall be acceptable in response to phase angle changes.

6.5.2.7 Frequency-droop (frequency-power)

6.5.2.7.1 Frequency-droop (frequency-power) capability

Depending on the DER *abnormal operating performance category* as described in Clause 4, the DER shall have the capability of *mandatory operation* with frequency-droop (frequency-power) during *low-frequency ride-through* and *high-frequency ride-through* as specified in Table 22.

¹⁰³ The values specified in Table 21 are intended for DER to withstand frequency disturbances that can occur in interconnected bulk power systems. Frequency disturbances during conditions where the bulk power system has split into multiple islands can have much larger ROCOF values than specified here.

Table 22—Requirements of a frequency-droop (frequency-power) operation for low-frequency conditions and high-frequency conditions for DER of abnormal operating performance Category I, Category II, and Category III

Category	Operation for low-frequency conditions	Operation for high-frequency conditions
I	Optional (may)	Mandatory (shall)
II	Mandatory (shall)	Mandatory (shall)
III	Mandatory (shall)	Mandatory (shall)

6.5.2.7.2 Frequency-droop (frequency-power) operation

During temporary frequency disturbances, for which the system frequency is outside the adjustable deadband db_{OF} and db_{UF} as specified in Table 24, but still between the trip settings in Table 18, the DER shall adjust its active power output from the pre-disturbance levels, according to the formulas in Table 23. The active power output shall be as defined by the relevant formula in Table 23, plus any inertial response to the rate of change of frequency, until frequency returns to within the deadband.

The DER response shall conform to the prioritization of DER responses specified in 4.7.

Figure H.7 shows three example curves of a frequency-droop function for which the DER is operating at different pre-disturbance levels of nameplate rating. A DER response during low-frequency conditions may be subject to *available active power* and the pre-disturbance dispatch level.

Table 23—Formula for frequency-droop (frequency-power) operation for low-frequency conditions and high-frequency conditions for DER for all performance categories

Operation for low-frequency conditions	Operation for high-frequency conditions
$p = \min_{f < 60 - db_{UF}} \left\{ p_{pre} + \frac{(60 - db_{UF}) - f}{60 \cdot k_{UF}}; p_{avl} \right\}$	$p = \max_{f > 60 + db_{OF}} \left\{ p_{pre} + \frac{f - (60 + db_{OF})}{60 \cdot k_{OF}}; p_{min} \right\}$

where

- p is the active power output,¹⁰⁴ in p.u. of the DER nameplate active power rating
- f is the disturbed system frequency in Hz
- p_{avl} is the *available active power*, in p.u. of the DER rating
- p_{pre} is the pre-disturbance active power output, defined by the active power output at the point of time the frequency exceeds the deadband, in p.u. of the DER rating
- p_{min} is the minimum active power output due to DER prime mover constraints, in p.u. of the
- db_{OF} is a single-sided deadband value for high-frequency and low-frequency, respectively, in Hz
- db_{UF} is a single-sided deadband value for high-frequency and low-frequency, respectively, in Hz
- k_{OF} is the per-unit frequency change corresponding to 1 per-unit power output change (frequency droop), unitless
- k_{UF} is the per-unit frequency change corresponding to 1 per-unit power output change (frequency droop), unitless

Adjustments to db_{OF} , db_{UF} , k_{OF} , k_{UF} , and $T_{response}$ (small-signal) shall be permitted in coordination with the Area EPS operator and the requirements of the *regional reliability coordinator*.

¹⁰⁴ Includes positive and negative active power for Energy Storage DER during low- and high-frequency conditions respectively. Use of alternate control means to meet this requirement is permitted.

Table 24—Parameters of frequency-droop (frequency-power) operation for DER of abnormal operating performance Category I, Category II, and Category III

Parameter	Default settings ^a			Ranges of allowable settings ^b		
	Category I	Category II	Category III	Category I	Category II	Category III
db_{OF}, db_{UF} (Hz)	0.036	0.036	0.036	0.017 ^c –1.0	0.017 ^c –1.0	0.017 ^c –1.0
k_{OF}, k_{UF}	0.05	0.05	0.05	0.03–0.05	0.03–0.05	0.02–0.05
T_{response} (small-signal) (s)	5	5	5	1–10	1–10	0.2–10

^aAdjustments shall be permitted in coordination with the Area EPS operator.

^bFor the single-sided deadband values (db_{OF}, db_{UF}) ranges, both the lower value and the upper value is a minimum requirement (wider settings shall be allowed). For the frequency droop values (k_{OF}, k_{UF}) ranges, the lower value is a limiting requirement (the setting shall not be set to lower values) and the upper value is a minimum requirement (the setting may be set to greater values). For the open-loop response time, $T_{\text{response (small-signal)}}$, the upper value is a limiting requirement (the setting shall not be set to greater values) and the lower value is a minimum requirement (the setting may be set to lower values). Any settings different from the default settings in Table 24 shall be approved by the *regional reliability coordinator* with due consideration of system dynamic oscillatory behavior.

^cA deadband of less than 0.017 Hz shall be permitted.

The time performance of the frequency-droop (frequency/power) operation for all three DER Performance Categories as described in Clause 4 shall have the following characteristics:

- a) Small-signal performance (a frequency deviation resulting in a power change of less than 5% of Rated Active Power): the open-loop response time $T_{\text{response (small-signal)}}$ of the DER shall be adjustable within the ranges specified in Table 24. If the Area EPS operator does not specify any settings, the default setting shall be 5 s. Any settings different from the default settings in Table 24 shall be approved by the *regional reliability coordinator* with due consideration of system dynamic oscillatory behavior.
- b) Large-signal performance (a frequency deviation resulting in a power change of equal to or greater than 5% of Rated Active Power): The DER shall not be required to change its active power output at a rate greater than 20% of nameplate rating per minute, in order to meet the minimum response requirement, if the Primary Energy Source is physically unable to provide a greater response rate.¹⁰⁵

6.5.2.8 Inertial response

Inertial response, in which the DER active power is varied in proportion to the rate of change of frequency, is not required but is permitted.¹⁰⁶

6.6 Return to service after trip

The Return to Service criteria for DER of Category I, Category, II, and Category III are specified in 4.10.

¹⁰⁵ The maximum available power ramp rate of the DER shall be as fast as technically feasible, and equal or greater than the minimum 20% per minute ramping capability requirement. This waiver of the minimum time requirement shall only apply for frequency changes of sufficient magnitude and rate of change so as to otherwise exceed the DER's power ramping capability.

¹⁰⁶ If Area EPS Operator and DER Operator mutually agree to use DER inertial response, the performance requirements should be coordinated with the *regional reliability coordinator* with due consideration of system dynamic oscillatory behavior.

7. Power quality

Refer to the informative [Annex G](#) for additional information regarding DER induced power quality phenomena, measurement, grid interactions, and planning levels.

7.1 Limitation of dc injection

The DER shall not inject dc current greater than 0.5% of the full rated output current at the reference point of applicability (RPA).

7.2 Limitation of voltage fluctuations induced by the DER

7.2.1 General

The DER shall not create unacceptable rapid voltage changes or flicker at the point of common coupling (PCC).

7.2.2 Rapid voltage changes (RVC)

When the PCC is at medium voltage, the DER shall not cause step or ramp changes in the RMS voltage at the PCC exceeding 3% of nominal and exceeding 3% per second averaged over a period of one second. When the PCC is at low voltage, the DER shall not cause step or ramp changes in the RMS voltage exceeding 5% of nominal and exceeding 5% per second averaged over a period of one second. Any exception to the limits is subject to approval by the Area EPS operator with consideration of other sources of RVC within the Area EPS.

These RVC limits shall apply to sudden changes due to frequent energization of transformers, frequent switching of capacitors or from abrupt output variations caused by DER misoperation. These RVC limits shall not apply to infrequent events such as switching, unplanned tripping, or transformer energization related to commissioning, fault restoration, or maintenance.¹⁰⁷

¹⁰⁷ Subclause 7.2.2 is not intended to address issues associated with slow voltage variations, which can be caused by cloud shadow passage, wind speed changes, etc.

7.2.3 Flicker

The DER contribution (emission values) to the flicker, measured at the PCC, shall not exceed the greater of the limits listed in Table 25 and the individual emission limits defined by IEC/TR 61000-3-7. Any exception to the limits shall be approved by the Area EPS operator with consideration of other sources of flicker within the Area EPS.

Table 25—Minimum individual DER flicker emission limits^a

$E_{P_{st}}$	$E_{P_{lt}}$
0.35	0.25

^a95% probability value should not exceed the emission limit based on a one week measurement period.

Assessment and measurement methods for flicker are defined in IEEE Std 1453 and IEC/TR 61000-3-7. In addition, the following shall apply:

- Equipment other than a DER shall be allowed to mitigate the flicker induced by a DER.
- $E_{P_{st}}$ is the emission limit for the short-term flicker severity, P_{st} . If not specified differently, the P_{st} evaluation time is 600 s.
- $E_{P_{lt}}$ is the emission limit for long-term flicker severity, P_{lt} . If not specified differently, the P_{lt} evaluation time is 2 h.
- P_{lt} can be calculated by using Equation (1).

$$P_{lt} = \sqrt[3]{\frac{1}{12} \sum_{i=1}^{12} P_{st_i}^3} \quad (1)$$

where ($i = 1, 2, 3, \dots$) are consecutive readings of the short-term severity P_{st}

7.3 Limitation of current distortion

Harmonic current distortion, inter-harmonic current distortion, and total rated-current distortion (TRD) at the *reference point of applicability* (RPA) shall not exceed the limits stated in the following paragraph and in Table 26 and Table 27.

The methodology for measuring harmonic and inter-harmonic values in this requirement is defined in IEEE Std 519.¹⁰⁸ Note that Table 26 and Table 27 differ from any table in IEEE Std 519. In this standard, the new term “Total Rated-current Distortion (TRD)” was introduced and used instead of TDD (in Table 26) and the even order current distortion limits above the second order are relaxed for DER (in Table 27).

Any aggregated harmonics current distortion between $h \pm 5$ Hz, where h is the individual harmonic order, shall be limited to the associated harmonic order h limit in Table 26 and Table 27. Any aggregated inter-harmonics current distortion between $h + 5$ Hz and $(h + 1) - 5$ Hz shall be limited to the lesser magnitude limit of h and $h + 1$ harmonic order in Table 26 and Table 27.

¹⁰⁸ IEEE Std 519 requires that the harmonic h be calculated as the root-sum-square of the spectral component value at the actual integer multiple of the fundamental frequency and spectral components in the adjacent ± 5 Hz bins from the gapless 10/12 cycle (approximately 200 ms) measurement window. All of the other 5 Hz bins spectral components are similarly combined using root-sum-square into the inter-harmonic value between adjacent harmonics.

These current distortion limits shall be exclusive of any harmonic currents due to harmonic voltage distortion present in the Area EPS without the DER connected. Upon mutual agreement between the Area EPS operator and the DER operator the DER may inject current distortion in excess of these tables, such as when it is used as an active filtering device.

Table 26—Maximum odd harmonic current distortion in percent of rated current (I_{rated})^a

Individual odd harmonic order h	$h < 11$	$11 \leq h < 17$	$17 \leq h < 23$	$23 \leq h < 35$	$35 \leq h < 50$ ¹⁰⁹	Total rated current distortion (TRD)
Percent (%)	4.0	2.0	1.5	0.6	0.3	5.0

^a I_{rated} = the DER unit rated current capacity (transformed to the RPA when a transformer exists between the DER unit and the RPA).

Table 27—Maximum even harmonic current distortion in percent of rated current (I_{rated})^a

Individual even harmonic order h	$h = 2$	$h = 4$	$h = 6$	$8 \leq h < 50$
Percent (%)	1.0	2.0	3.0	Associated range specified in Table 26

^a I_{rated} = the DER unit rated current capacity (transformed to the RPA when a transformer exists between the DER unit and the RPA).

The total rated current distortion (TRD) in Table 26, which includes the harmonic distortion and inter-harmonic distortion, can be calculated using Equation (2):

$$\%TRD = \frac{\sqrt{I_{rms}^2 - I_1^2}}{I_{rated}} \times 100\% \quad (2)$$

where

- I_1 is the fundamental current as measured at the RPA
- I_{rated} is the DER rated current capacity (transformed to the RPA when a transformer exists between the DER unit and the RPA)
- I_{rms} is the root-mean-square of the DER current, inclusive of all frequency components, as measured at the RPA

7.4 Limitation of overvoltage contribution

7.4.1 Limitation of overvoltage over one fundamental frequency period

The DER shall not contribute to instantaneous or fundamental frequency overvoltages with the following limits:

- a) The DER shall not cause the fundamental frequency line-to-ground voltage on any portion of the Area EPS that is designed to operate effectively grounded, as defined by IEEE Std C62.92.1, to exceed 138% of its nominal line-to-ground fundamental frequency voltage for a duration exceeding one fundamental frequency period.

¹⁰⁹ Typical utility instrument transformers may not be able to accurately reproduce high order harmonic content. Adherence to the higher order harmonics may need to be confirmed in a laboratory setting or, if in the field, using equipment designed for use at the frequencies in question. Refer to Annex G for more information.

- b) The DER shall not cause the line-to-line fundamental frequency voltage on any portion of the Area EPS to exceed 138% of its nominal line-to-line fundamental frequency voltage for a duration exceeding one fundamental frequency period.

7.4.2 Limitation of cumulative instantaneous overvoltage

The DER shall not cause the instantaneous voltage on any portion of the Area EPS to exceed the magnitudes and cumulative durations shown in Figure 3. The cumulative duration shall only include the sum of durations for which the instantaneous voltage exceeds the respective threshold over a one-minute time window.¹¹⁰

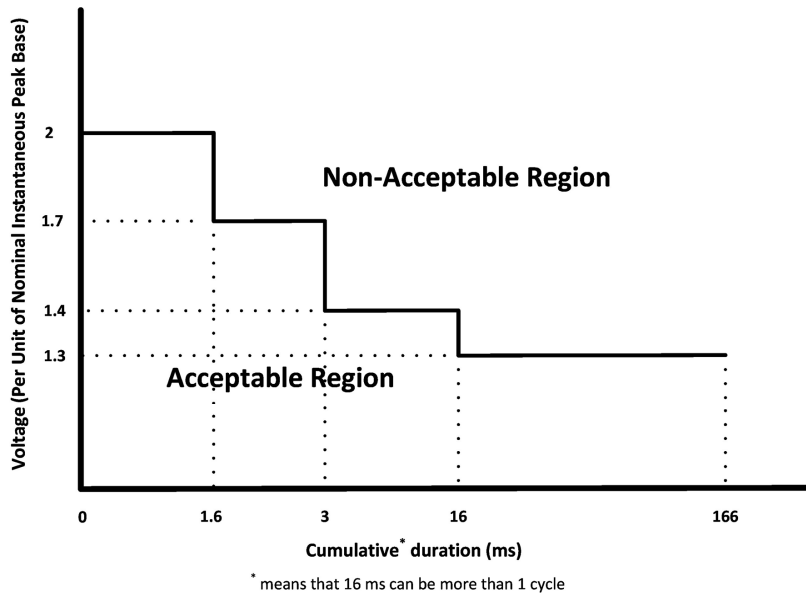
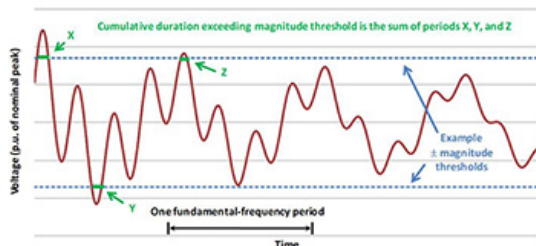

Figure 3 —Transient overvoltage limits

¹¹⁰ Cumulative duration is illustrated as follows:



8. Islanding

8.1 Unintentional islanding

8.1.1 General

For an *unintentional island* in which the DER energizes a portion of the Area EPS through the PCC, the DER shall detect the island, *cease to energize* the Area EPS, and trip within 2 s of the formation of an island.¹¹¹ False detection of an *unintentional island* that does not actually exist shall not justify non-compliance with ride-through requirements as specified in [Clause 6](#).

8.1.2 Conditional extended clearing time

Upon mutual agreement between the Area EPS operator and the DER operator, the *clearing time* may be extended from 2 s to as much as 5 s.¹¹²

8.1.3 Area EPS with automatic reclosing

Requirements with regard to Area EPS automatic reclosing coordination are specified in [6.3](#).¹¹³

8.2 Intentional islanding

8.2.1 General

An intentional island can be an intentional Area EPS island or an intentional Local EPS island. The requirements in [8.2](#) apply to both.

An *intentional island* that includes any portion of the Area EPS is an *intentional Area EPS island*. An *intentional Area EPS island*, while islanded, shall be designed and operated in coordination with the Area EPS operator.

An *intentional island* that is totally within the bounds of a Local EPS is an *intentional Local EPS island*.¹¹⁴ DER that support *intentional Local EPS islands*, while interconnected to an Area EPS that is not islanded, shall be subject to all requirements for interconnection of DER to Area EPS specified in [Clause 4](#) through [8.1](#) of this standard.

There are two means by which an *intentional island* system can transition to an islanded condition: scheduled and unscheduled.

¹¹¹ Reliance solely on under/over voltage and frequency trip is not considered sufficient to detect and *cease to energize* and trip. IEEE Std 1547.2™ [\[B18\]](#) may provide additional guidance on *unintentional island* mitigation, and additional equipment (e.g., transfer trip) may be necessary.

¹¹² To achieve coordination between unintentional islanding detection and automatic reclosing, auto-reclose times longer than 2 s may be considered in some circumstances.

¹¹³ It is important to bear in mind that islanding detection methods in inverters are generally designed to detect islands with a generation-load balance. They are *not* intended or designed to detect faults and should not be relied upon for that purpose.

¹¹⁴ Also called “Facility Island,” see [Annex C](#).

8.2.2 Scheduled intentional islands

Scheduled *intentional islands* are formed through DER operator or Area EPS operator manual action or other operating dispatch means (e.g., Energy Management System or Automatic Generator Control action) that trigger the transition from being in parallel and synchronized with the Area EPS, to operation as an islanded system. Reasons for forming a scheduled *intentional island* can include enhanced reliability, economic dispatch decisions for self-supply or import/export of power with or through the Area EPS, or pre-emptive Area EPS operator action to island ahead of inclement weather.

8.2.3 Unscheduled intentional islands

Unscheduled *intentional islands* are formed autonomously from local detection of abnormal conditions at the interconnection(s) with the Area EPS, and then automatic relay action that triggers switching action to isolate the *intentional island* rapidly from the Area EPS.

8.2.4 Conditions for unscheduled transition to intentional island

An *intentional island* may disconnect from the Area EPS and transition to *intentional island* mode for any of the following conditions:

- Whenever any of the exception conditions described in 6.4.2.1 and 6.5.2.1 are met, or
- If any of the trip conditions described in Clause 6 are met (i.e., where Clause 6 would allow or mandate tripping, the *intentional island* may transition to *intentional island* mode), or
- If the conditions of 8.1 are met (i.e., the DER detects an island and the DER ceases to energize the Area EPS under 8.1), the *intentional island* may enter *intentional island* mode instead of ceasing to energize the Area EPS, provided that the *intentional island* does not energize any part of the Area EPS that is outside the defined *intentional island*).

8.2.5 Transition of an intentional island from the Area EPS

If an *intentional island* that does not qualify as an exception under 6.4.2.1 or 6.5.2.1 disconnects from the Area EPS when the voltage and frequency of the Area EPS are within the *Continuous Operation* ranges defined in Clause 6, the conditions of 7.2.2, as applicable, shall be met.

8.2.6 Reconnection of an intentional island to the Area EPS

An *intentional island* that has disconnected from the rest of the Area EPS may reconnect to the rest of the Area EPS when the conditions listed in 4.10 are met at the *intentional island* point of common coupling. When the *intentional island* reconnects to the Area EPS, the conditions of 4.10.4 shall be met.

8.2.7 Adjustments to DER settings

When operating in an *intentional Area EPS island*, participating DER may have to adjust several control and protection settings. These alternate settings and *ranges of allowable settings*, including those specified in 8.2.7, shall be enabled only when the *intentional Area EPS island* is isolated from the Area EPS. In order to meet this requirement, adaptive protection and control settings may be required.

For DER operating in an *intentional Area EPS island*, the following requirements apply:

- 5.2 (reactive power capability of the DER) and 5.3 (voltage and reactive power control) for all aggregate DER ratings.

- 6.4.1 (mandatory voltage tripping) the *range of allowable settings* in overvoltage trip function 2 (OV2) shall be 0.008 s to 0.16 s for all three categories, in Table 11, Table 12, and Table 13.
- 6.5.1 (mandatory frequency tripping) the *range of allowable settings* in overfrequency trip setting 1 (OF1) and underfrequency trip setting 1 (UF1) shall be 11 s to 1000 s for all three categories, in Table 18.
- 6.5.2.7 (frequency-droop) for all aggregate DER ratings. For DER complying with Category III of Table 23, the frequency droop (k_{OF}) shall be adjustable from 0.0055 to 0.05 per-unit. For participating DER in Category III of Table 24, the lower value of the range of allowable settings of the open-loop response time is not applicable.
- Shall be capable of operating in Area EPS-connected mode, in *intentional island* mode, and transitioning between those two states.

8.2.8 DER categories for intentional islands

A DER that participates in an *intentional Area EPS island* shall be categorized in one of the following ways:

- 1) *Uncategorized*: A DER not designed for *intentional island* operation may be allowed to participate in the *intentional island* if certain system criteria are met (for examples of this, please see Annex C). Otherwise, it shall *cease to energize* the Area EPS during *intentional island* mode, as if it were an *unintentional island*.
- 2) *Intentional island-capable*: Applies to DER that can disable or modify its islanding detection function, and adjust settings as described in 8.2.7.
- 3) *Black start-capable*: Applies to *intentional island-capable* DER that can also energize an EPS that contains no other energy sources.
- 4) *Isochronous-capable*: Applies to DER that can independently regulate voltage and frequency to fixed set points.

These categories shall be stated by the DER operator, but utilization shall be by mutual agreement between the DER operator and the operator of the *intentional Area EPS island*. In no case shall a DER be required to operate outside of the voltage, current, and frequency ratings required to provide capabilities and performance as mandated by this standard.

9. DER on distribution secondary grid/area/street (grid) networks and spot networks

9.1 Network protectors and automatic transfer scheme requirements

Network protectors (NPs) shall not be used to connect, separate, switch, serve as breaker failure backup, or in any manner isolate a network or network primary feeder to which DER is connected from the remainder of the network, unless the protectors are rated and tested per applicable standards for such an application.¹¹⁵

Unless specified otherwise by the Area EPS operator, DER installations on a network, using an automatic transfer scheme in which load is transferred between the DER and the EPS in a momentary make-before-break operation, shall meet all the requirements of this clause regardless of the duration of paralleling.

¹¹⁵ IEEE Std C57.12.44™ [B25] provides guidance on the capabilities of network systems to accept distributed resources.

Power flow during this transition shall be positive from the Area EPS to the load and the DER unless approved by and coordinated with the Area EPS operator.

DER on grid or spot networks shall have provisions to

- Monitor instantaneous power flow at the PCC of the DER interconnected to the secondary grid or spot network for reverse power relaying, minimum import relaying, dynamically controlled inverter functions and similar applications to prevent reverse power flow through network protectors.
- Maintain a minimum import level at the PCC as determined by the Area EPS operator.
- Control DER operation or disconnect the DER from the Area EPS based on an autonomous setting at the PCC and/or a signal sent by the Area EPS operator.

DER on grid or spot networks shall not

- Cause any NP to exceed its loading or fault-interrupting capability.
- Cause any NP to separate dynamic sources.
- Cause any NP to connect two dynamic systems together.
- Cause any NP to operate more frequently than prior to DER operation.
- Prevent or delay the NP from opening for faults on the Area EPS.
- Delay or prevent NP closure.
- Energize any portion of an Area EPS when the Area EPS is de-energized.
- Require the NP settings to be adjusted except by consent of the Area EPS operator.
- Prevent reclosing of any network protectors installed on the network. This coordination shall be accomplished without requiring any changes to prevailing network protector *clearing time* practices of the Area EPS.

9.2 Distribution secondary grid networks

In addition to the requirements in 9.1, DER on secondary grid networks shall not cause an islanding condition within that network.

In addition to the requirements in 9.1, in the event of an adjacent feeder fault, network protector master relays shall not be actuated by the presence of DER. The interconnected DER shall be coordinated with NP relay functions and shall be evaluated by the Area EPS operator to ensure network reliability.

9.3 Distribution secondary spot networks

In addition to the requirements in 9.1, connection of the DER to the Area EPS is only permitted if the Area EPS network bus is already energized by more than 50% of the installed network protectors.¹¹⁶

¹¹⁶ See IEEE Std 1547.6 [B21] for more explanation for this requirement.

10. Interoperability, information exchange, information models, and protocols¹¹⁷

10.1 Interoperability requirements

A DER shall have provisions for a local DER interface capable of communicating (*local DER communication interface*) to support the information exchange requirements specified in this standard for all applicable functions that are supported in the DER.

Under mutual agreement between the Area EPS operator and DER operator additional communication capabilities are allowed.

The decision to use the *local DER communication interface* or to deploy a communication system shall be determined by the Area EPS operator.

Emergency and standby DER are exempt as specified in 4.13 from the interoperability requirements specified in this standard.

10.2 Monitoring, control, and information exchange requirements

The specific DER functionality required by this standard results in the set of mandatory information elements identified in 10.3 through 10.6. These information elements shall be supported by the DER as indicated to support the associated DER functionality.

For information interoperability, these communication capabilities shall use a unified information model, and non-proprietary protocol encodings based on international standards or open industry specifications as described in 10.7.

The information to be exchanged falls into the following four categories:

- Nameplate information: This information is indicative of the as-built characteristics of the DER. This information may be read.
- Configuration information: This information is indicative of the present capacity and ability of the DER to perform functions. This information may be read or written.
- Monitoring information: This information is indicative of the present operating conditions of the DER. This information may be read.
- Management information: This information is used to update functional and mode settings for the DER. This information may be read or written.

10.3 Nameplate information

Nameplate information shall be available through a *local DER communication interface* and include at a minimum the information contained in Table 28.

¹¹⁷ This standard mandates these interoperability capabilities; however, how they are implemented, recorded, and reported is up to local jurisdictions and should be addressed in those processes and procedures (such as interconnection agreements).

Table 28—Nameplate information

Parameter	Description
Active power rating at unity power factor (nameplate active power rating)	Active power rating in watts at unity power factor
Active power rating at specified over-excited power factor	Active power rating in watts at specified over-excited power factor
Specified over-excited power factor	Over-excited power factor as described in 5.2
Active power rating at specified under-excited power factor	Active power rating in watts at specified under-excited power factor
Specified under-excited power factor	Under-excited power factor as described in 5.2
Apparent power maximum rating	Maximum apparent power rating in voltamperes
Normal operating performance category	Indication of reactive power and voltage/power control capability. (Category A/B as described in 1.4)
Abnormal operating performance category	Indication of voltage and frequency ride-through capability Category I, II, or III, as described in 1.4
Reactive power injected maximum rating	Maximum injected reactive power rating in vars
Reactive power absorbed maximum rating	Maximum absorbed reactive power rating in vars
Active power charge maximum rating	Maximum active power charge rating in watts
Apparent power charge maximum rating	Maximum apparent power charge rating in voltamperes. May differ from the apparent power maximum rating
AC voltage nominal rating	Nominal AC voltage rating in RMS volts
AC voltage maximum rating	Maximum AC voltage rating in RMS volts
AC voltage minimum rating	Minimum AC voltage rating in RMS volts
Supported control mode functions	Indication of support for each control mode function
Reactive susceptance that remains connected to the Area EPS in the <i>cease to energize</i> and trip state	Reactive susceptance that remains connected to the Area EPS in the <i>cease to energize</i> and trip state
Manufacturer	Manufacturer
Model	Model
Serial number	Serial number
Version	Version

10.4 Configuration information

Configuration information shall be available through a *local DER communication interface* to allow the setting and reading of the currently active values.

Each rating in Table 28 may have an associated configuration setting that represents the as-configured value. If a configuration setting value is different from the corresponding nameplate value, the configuration setting value shall be used as the rating within the DER. Changes to the configuration setting shall be made with mutual agreement between the DER system operator and Area EPS operator.

Configuration settings are intended to be used as a configuration option as nameplate alternatives. Configuration settings are not intended for continuous dynamic adjustment.

10.5 Monitoring information

The DER shall be capable of providing monitoring information through a *local DER communication interface* at the reference point of applicability and shall include at a minimum the information contained in Table 29. The information shall be the latest value that has been measured within the required response time.

Table 29—Monitoring information

Parameter	Description
Active Power	Active power in watts
Reactive Power	Reactive power in vars
Voltage	Voltage(s) in volts. (One parameter for single-phase systems and three parameters for three-phase systems)
Frequency	Frequency in Hertz
Operational State	Operational state of the DER. The operational state should represent the current state of the DER. The minimum supported states are on and off but additional states may also be supported
Connection Status	Power-connected status of the DER
Alarm Status	Active alarm status
Operational State of Charge	0% to 100% of operational energy storage capacity

10.6 Management information

10.6.1 General

Management information is used to update functional and mode settings for the DER. This information may be read or written.

10.6.2 Constant power factor mode parameters

Parameters for constant power factor mode as described in 5.3.2 shall be available for reading and writing through a *local DER communication interface*. Power factor value and excitation encoding are protocol-dependent. See Table 30.

Table 30—Constant power factor mode parameters

Parameter	Description	Range
Constant Power Factor Mode Enable	Enable constant power factor mode	On/Off
Constant Power Factor	Constant power factor setting	0–1
Constant Power Factor Excitation	Constant power factor excitation setting	Over-excited or under-excited

NOTE—The terms “over-excited” and “under-excited” are illustrated in the informative Figure H.3 in Annex H.

10.6.3 Voltage-reactive power mode parameters

Parameters for voltage-reactive power mode as described in 5.3.3 shall be available for reading and writing through a *local DER communication interface*. See Table 31.

Table 31—Voltage-reactive power mode parameters

Parameter	Description	Range
Voltage-Reactive Power Mode Enable	Enable voltage-reactive power mode	On/Off
V_{Ref}	Reference voltage	0.95–1.05 p.u. V nominal
Autonomous V_{Ref} adjustment enable	Enable/disable autonomous V_{Ref} adjustment	On/Off
V_{Ref} adjustment time constant	Adjustment range for V_{Ref} time constant	300 s to 5000 s
V/Q Curve Points	Voltage-reactive power curve points	See Table 8
Open Loop Response Time	Time to ramp up to 90% of the new reactive power target in response to the change in voltage	1 s to 90 s

10.6.4 Active power-reactive power mode parameters

Parameters for active power-reactive power mode as described in 5.3.4 shall be available for reading and writing through a *local DER communication interface*. See [Table 32](#).

Table 32—Active power-reactive power mode parameters

Parameter	Description	Range
Active Power-Reactive Power Mode Enable	Enable active power-reactive power mode	On/Off
P/Q Curve Points	Active power-reactive power curve points	See Table 9

10.6.5 Constant reactive power mode parameters

Parameters for constant reactive power mode as described in 5.3.5 shall be available for reading and writing through a *local DER communication interface*. See [Table 33](#).

Table 33—Constant reactive power mode parameters

Parameter	Description	Range
Constant Reactive Power Mode Enable	Enable constant reactive power mode.	On/Off
Constant Reactive Power	Constant reactive power setting.	Refer to Table 7 for reactive power settings for Category A and B DER

10.6.6 Voltage-active power mode parameters

Parameters for voltage-active power mode as described in 5.4.2 shall be available for reading and writing through a *local DER communication interface*. See [Table 34](#).

Table 34—Voltage-active power mode parameters

Parameter	Description	Range
Voltage-Active Power Mode Enable	Enable voltage-active power mode.	On/Off
V/P Curve Points	Voltage-active power curve points.	See Table 10
Open Loop Response Time	Time to ramp up to 90% of the new active power target in response to the change in voltage.	0.5–60 s

10.6.7 Voltage trip and momentary cessation parameters

Parameters for voltage trip as described in 6.4.1 shall be available and the *momentary cessation* threshold as specified in 6.4.2.1 may be available for information exchange through a *local DER communication interface*. Both settings, if applicable, shall be specified as a set of piecewise linear curves that define the regions associated with the voltage regions described in the functional description. See Table 35 (mandatory) and Table 36 (not mandatory).

Table 35—Voltage trip parameters

Parameter	Description	Range
HV Trip Curve Points	High-voltage shall trip curve points.	See Table 11 through Table 13
LV Trip Curve Points	Low-voltage shall trip curve points.	See Table 11 through Table 13

Table 36—Momentary cessation parameters (not mandatory)

Parameter	Description	Range
HV Momentary Cessation Curve Points	High-voltage momentary cessation curve points. Support for this setting is not mandatory.	Refer to 6.4.2.7.3
LV Momentary Cessation Curve Points	Low-voltage momentary cessation curve points. Support for this setting is not mandatory.	Refer to 6.4.2.7.3

10.6.8 Frequency trip parameters

Parameters for frequency trip as described in 6.5.1 shall be available for reading and writing through a *local DER communication interface*. Frequency trip settings shall be specified as a set of piecewise linear curves that define the regions associated with the frequency regions described in the functional description. See Table 37.

Table 37—Frequency parameters

Parameter	Description	Range
HF Trip Curve Points	High frequency shall trip curve points	See Table 18
LF Trip Curve Points	Low frequency shall trip curve points	See Table 18

10.6.9 Frequency droop parameters

Parameters for frequency droop as described in 6.5.2.7 shall be available for reading and writing through a *local DER communication interface*. See Table 38.

Table 38—Frequency droop parameters

Parameter	Description	Range
Overfrequency Droop db_{OF}	Frequency droop deadband for overfrequency conditions	See Table 24
Underfrequency Droop db_{UF}	Frequency droop deadband for underfrequency conditions	See Table 24
Overfrequency Droop k_{OF}	Frequency droop per-unit frequency change for overfrequency conditions corresponding to 1 per-unit power output change	See Table 24
Underfrequency Droop k_{UF}	Frequency droop per-unit frequency change for underfrequency conditions corresponding to 1 per-unit power output change	See Table 24
Open Loop Response Time	The duration from a step change in control signal input until the output changes by 90% of its final change, before any overshoot	See Table 24

10.6.10 Enter service

Parameters for *enter service* as described in 4.10 shall be available for reading and writing through a *local DER communication interface*. See Table 39.

Table 39—Enter service after trip parameters

Parameter	Description	Range
Permit service	Able to enter or stay in service	Enabled/Disabled
ES Voltage High	Enter service voltage high	See Table 4
ES Voltage Low	Enter service voltage low	See Table 4
ES Frequency High	Enter service frequency high	See Table 4
ES Frequency Low	Enter service frequency low	See Table 4
ES Delay	Enter service delay	0–600 s
ES Randomized Delay	Enter service randomized delay	1–1000 s
ES Ramp Rate	Enter service ramp rate	1–1000 s

10.6.11 Cease to energize and trip

A DER can be directed to *cease to energize* and trip by changing the Permit service setting to “disabled” as described in 4.10.3.

10.6.12 Limit maximum active power

Parameters to limit maximum active power as specified in 4.6.2 shall be available for reading and writing through a *local DER communication interface*. See Table 40.

Table 40—Limit maximum active power parameters

Parameter	Description	Range
Limit Active Power Enable	Enable mode	On/Off
Maximum Active Power	Maximum active power setting	Refer to 4.6.2

10.7 Communication protocol requirements

The protocol requirements set forth in this subclause apply at the *local DER communication interface*. As illustrated in Figure 4, the protocols and physical layers utilized within communication networks and within the DER may differ according to the network architecture and technology, and are out of scope of this standard.¹¹⁸

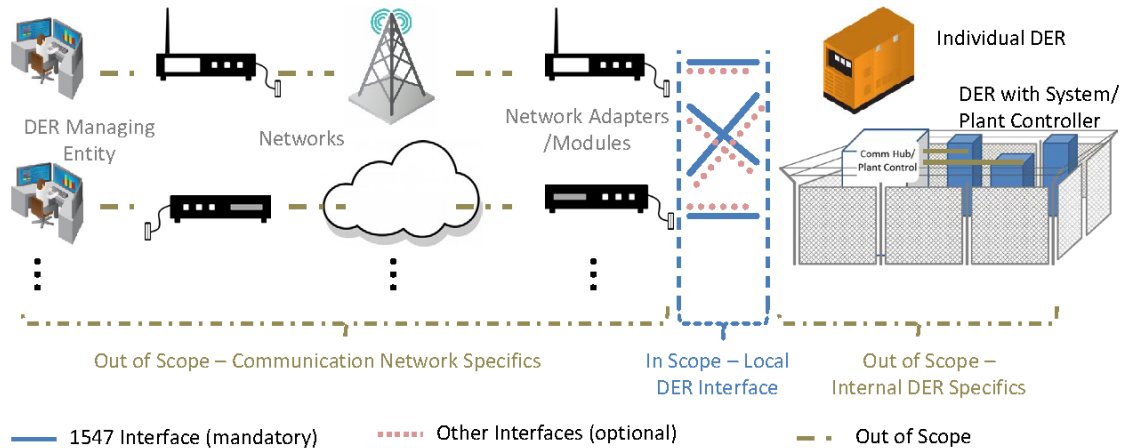

Figure 4 —Control protocol in/out of scope mapping

The DER shall support at least one of the protocols specified in Table 41. The protocol to be utilized may be specified by the Area EPS operator. Additional protocols, including proprietary protocols, may be allowed under mutual agreement between Area EPS operator and DER operator. Additional physical layers may be supported along with those specified in the table.

Table 41 —List of eligible protocols

Protocol	Transport	Physical layer
IEEE Std 2030.5 (SEP2)	TCP/IP	Ethernet
IEEE Std 1815 (DNP3)	TCP/IP	Ethernet
SunSpec Modbus	TCP/IP	Ethernet
	N/A	RS-485

10.8 Communication performance requirements

Communication performance requirements for the interface to DER are set forth in Table 42. These requirements do not constrain or define the performance of various communication systems that may be utilized to integrate DER, but only apply to the DER themselves.

¹¹⁸ For example, the Area EPS operator may deploy networks that utilize the IEEE 2030.5 protocol even if it is not the native protocol supported at the *local DER communication interface*. The standard protocol support requirement does not preclude the use of additional protocols such as the information model defined by IEC 61850-7-420 [B8] exchanged using IEC 61850-8-1 [B9] or IEC 61850-8-2 [B10], or profiles of the IEC 61850-7-420 information model mapped to IEEE Std 1815 (DNP3) or to SunSpec Modbus.

Table 42—Communication performance requirements for DER interfaces

Parameter	Requirement	Description
Availability of communication	When DER is operational	The <i>local DER communication interface</i> shall be active and responsive whenever the DER is operating and in a <i>continuous operation region</i> or <i>mandatory operation region</i> .
Information read response time	≤ 30 s	The maximum amount of time to respond to read requests.

10.9 Cyber security requirements

It is recognized that cybersecurity is a critically important issue for DER deployments connected to broader monitoring and control communications networks. Each standardized *local DER communication interface* option provides different security capabilities. The interoperability and communications cyber security requirements of specific DER deployments may be based on mutual agreement and may also be subject to regulatory requirements that may vary across jurisdictions.

This standard, therefore, does not mandate specific cyber security requirements at the DER interface. Specific security requirements are beyond the scope of this standard.

See [D.4](#) for more information about cyber security standards.

11. Test and verification requirements

11.1 Introduction

The technical requirements specified in [Clause 4](#) through [Clause 10](#) define the interconnection and interoperability requirements of this standard. These requirements are tested and verified in accordance with the requirements identified in [Clause 11](#).

The requirements contained in this standard identify the necessary conditions that shall be verified to improve proper and reliable operation of the DER. These requirements include properties of the DER, properties that shall be maintained at operational interfaces, and properties that are needed throughout the life of the installed system. All DER verification requirements contained in this document shall be met, and then verified in accordance with IEEE Std 1547.1 [\[B17\]](#). Depending upon the circumstances and selected verification method, it is possible that additional requirements may be imposed to establish confidence in means of verification, e.g., traceability to national standards, accuracy of recorded data, conditions of unit under test, temporary patches and turnarounds.

This clause specifies the applicable testing and verification methods to verify that a DER meets the interconnection and interoperability requirements specified in [Clause 4](#) through [Clause 10](#) at the applicable reference point as specified in [4.2](#). This clause further specifies at which stage in the interconnection process testing and verification shall be required. The applicable test and verification methods from this clause are required for all DERs.¹¹⁹ The results of these test and verification methods shall be formally documented.¹²⁰

¹¹⁹ The stated test specifications and requirements are universally needed for interconnection of DER including synchronous machines, induction machines, or static power inverters/converters, and are sufficient for most installations.

¹²⁰ The responsibilities, procedures, requirements, and criteria for the applicable test and verification methods are specified in IEEE Std 1547.1 [\[B17\]](#).

11.2 Definition of test and verification methods

11.2.1 General

All DER interconnection and interoperability requirements of this standard shall be demonstrated through either type tests, production tests, DER evaluation, commissioning tests, or periodic tests or a combination of these tests and verification methods. Requirements and capabilities that are only partially¹²¹ verified through type testing shall be fully verified through DER evaluation and commissioning tests.

11.2.2 Type tests

A type test may be performed on one device or combination of devices. In case of a combination of devices forming a system, this test shows that the devices are able to operate together as a system.

Type tests shall be performed, as applicable, to the specific DER unit or DER system. The tests shall be performed on a representative DER unit or DER system, either in the factory, at a testing laboratory, or on equipment in the field. Type test results from a DER within a product family of the same design, including hardware and software, shall be allowed as representative of other DERs within the same product family with power ratings between 50% to 200% of the tested DER.

For systems in the field, replacement of DER equipment with substitutive components compliant and tested with this standard shall be allowed and not invalidate previous type test and production test results. However, field demonstration of performance shall be as agreed with the EPS operator and DER operator.

11.2.3 Production tests

Production tests shall be conducted on every unit of DER and interconnect of equipment prior to customer delivery as to verify that they meet applicable standards.

Production tests shall verify the operability of every unit of DER and interconnect equipment manufactured for customer use. These tests assume that the equipment has met the applicable interconnection and interoperability requirements of this standard and may be conducted as a factory test or performed as part of a DER evaluation or commissioning test. The summary reporting shall provide a list of normal and abnormal performance category capability, final function settings, and final operating mode settings.

Manufacturers having certified production facilities or proven production processes and quality control methods certified by a NRTL shall be allowed to use said approved practices and documentation for fulfilment of production test requirements.

For systems in the field, replacement of DER equipment with substitutive components compliant and tested with this standard shall be allowed and not invalidate previous production test results. However, field demonstration of performance shall be as agreed with the Area EPS operator and DER operator.

¹²¹ Partial verification may occur for DER that may have to meet requirements at the PCC per [Clause 4](#) or that require a supplemental DER device to meet requirements at the PoC.

11.2.4 DER evaluation

11.2.4.1 General

DER evaluation comprises a design evaluation desk study during the interconnection review process and an as-built installation evaluation on site at the time of commissioning to verify that the composite of the individual partially compliant DER(s) and, if applicable, the supplemental DER device(s) forming a system meet the interconnection and interoperability requirements of this standard.

11.2.4.2 DER design evaluation (desk study)

The design evaluation (desk study) is an evaluation during the interconnection review process to verify that the composite of the individual partially compliant DERs forming a system as designed meets the interconnection and interoperability requirements of this standard. This evaluation is usually done off-site before equipment is delivered and installed.

11.2.4.3 DER as-built installation evaluation (on-site)

The as-built installation evaluation (on-site) is an evaluation at the time of commissioning to verify that the composite of the individual partially compliant DERs forming a system as delivered and installed meets the interconnection and interoperability requirements of this standard. This evaluation does not require testing.

11.2.4.4 Basic and detailed DER evaluation

A basic DER evaluation shall be limited to verify that the DER has been designed and installed with the proper components and connections. A detailed DER evaluation shall include an engineering verification of the chosen components and may require modeling and simulation of the composite of the individual partially compliant DERs forming a system.

11.2.5 Commissioning tests and verifications

11.2.5.1 General

Commissioning tests are tests and verifications on one device or combination of devices forming a system to confirm that the system as designed, delivered, and installed meets the interconnection and interoperability requirements of this standard.

All commissioning tests shall be performed based on written test procedures. Test procedures are provided by equipment manufacturers(s) or system designer(s) and approved by the equipment owner and Area EPS operator. Commissioning tests shall include visual inspections and may include, as applicable, operability and functional performance test.

11.2.5.2 Basic and detailed functional commissioning test

A basic functional commissioning test includes visual inspection and an operability test on the isolation device. A detailed functional commissioning test shall include a basic functional test and functional tests to verify interoperability of a combination of devices forming a system to verify that the devices are able to operate together as a system.

11.2.6 Periodic tests and verifications

Periodic tests are tests and verifications, according to a scheduled time period or other criteria, that confirm that one already interconnected device or combination of devices forming a system meets the interconnection and interoperability requirements of this standard.

Periodic test requirements and intervals for all interconnection-related protective functions and associated batteries shall be provided by interconnection equipment manufacturers or system integrator and approved by, the AGIR or the Area EPS operator. Frequency of retesting shall be determined by Area EPS operator policies for protection system testing, or manufacturer requirements. Periodic test reports or a log for inspection shall be maintained.

The Area EPS operator may require a commissioning test be performed outside of the normal periodic testing to verify adherence to this standard at any time.

For systems in the field, replacement of DER equipment with substitutive components compliant to this standard shall be allowed and not invalidate previous type test and production test results. The Area EPS operator may still require commissioning testing on any equipment replaced.

Information describing facility changes such as; (software, firmware, hardware) shall be available to the Area EPS operator through the interoperability requirements of [Clause 10](#). Reverification of the interconnection and interoperability requirements of this standard may be required when any of the following events occur:

- Functional software or firmware changes have been made on the DER.
- Any hardware component of the DER has been modified in the field or has been replaced or repaired with parts that are not substitutive components compliant with this standard.
- Protection settings have been changed after factory testing.
- Protection functions have been adjusted after the initial commissioning process.

11.3 Full and partial conformance testing and verification

11.3.1 General

Requirements define the capability, design, and performance of a built system. Test and verification is confirming that the requirements have been satisfactorily met. The test and verification requirements are specified by use of a test requirements matrix as described in [Table 43](#) and [Table 44](#). These matrices provide a means of traceability between the need to verify a given requirement and the means of verification. These matrices help ensure that there is consistency throughout the stages in interconnection process testing and verification for DER that shall meet requirements in [Clause 4](#) through [Clause 10](#). Test requirement matrices provide minimum testing requirements for traceability, but the Area EPS operator shall not be limited from requiring supplemental commissioning testing and verification.

Note that this document presents two traceability matrices—one for connections at the PCC and one for requirements to be tested at the PoC. As indicated in [4.2](#), many applications exist where the applicable point for meeting performance requirements shall be the PoC. This includes small-scale DER, applications where DER units are interconnected to Local EPS having substantial load.

According to 4.2, the requirements of this standard apply either at the PCC or the PoC, depending on the aggregate nameplate DER rating and the average annual load in the Local EPS.¹²² Where requirements apply at the PoC, equipment type testing will be sufficient to verify conformance with most requirements, in most cases. However, for DER facilities, i.e., Local EPS that are large enough so that requirements apply at the PCC, equipment testing will have to be supplemented by additional compliance verification measures such as the DER evaluation and further commissioning tests defined above. The same holds for any DER that use supplemental DER devices to meet the requirements of this standard. Annex F provides further information concerning testing and verification requirements at the PCC or PoC, including the concept of combined type test and DER evaluation.

NOTE—Subclause 11.3 only maps the required test and verification procedures to the performance requirements of this standard. The subclause does not specify exactly how these procedures are implemented. The details of the actual test and verification procedures are specified in IEEE Std 1547.1 [B17].

11.3.2 DER that shall meet requirements at the PCC

This subclause outlines a methodology for testing and verification of DER that may be used to demonstrate conformance at the PCC per Clause 4 through Clause 10 for interconnection and interoperability requirements of this standard. The Area EPS operator may have additional requirements for the interconnection.

For DER that shall meet requirements at the PCC per 4.2, Table 43 specifies the test and verification requirements.¹²³

The DER system or DER unit¹²⁴ shall be classified as either fully compliant or partially compliant. Type tests, DER evaluations, and commissioning tests shall be done as indicated in the table for all line items under the appropriate classification.

¹²² As per 4.2 some DER units have some requirements that shall be met at the PCC and other requirements that shall be met at the PoC.

¹²³ The corresponding responsibilities, procedures, requirements, and criteria for the applicable test and verification methods are specified in IEEE Std 1547.1 [B17].

¹²⁴ Individual DER units that are considered fully compliant at the PoC may only be considered fully compliant at the PCC if the impedance between the PoC and the PCC is less than 0.5% on the DER rated apparent power and voltage base.

Table 43—Interconnection test specifications and requirements for DER that shall meet requirements at the PCC

LEGEND	
DER system	DER system is fully compliant at PCC*—no supplemental DER device needed *Individual DER units that are considered fully compliant at the PoC may only be considered fully compliant at the PCC if the impedance between the PoC and the PCC is less than 0.5% on the DER rated apparent power and voltage base.
Composite	Composite of partially compliant DER that is, as a whole, fully compliant at PCC*—may need one or more supplemental DER device(s). *Individual DER units that are considered fully compliant at the PoC shall not be considered fully compliant at the PCC if the impedance between the PoC and the PCC is equal to or greater than 0.5% on the DER rated apparent power and voltage base.
NR	Not Required
R	Required
L	Limited type testing is limited to partial compliance of the individual DER unit or DER system in order to evaluate the DER unit or DER system performance characteristics for later use in the DER evaluation that verifies full compliance of the composite DER at the PCC. The DER unit or DER system may not have any compliance at all with certain requirements, leaning on the supplemental equipment to comply.
D	Dependent on DER Design Evaluation
NA	Not Applicable

Requirement	Compliance at PCC achieved by:	Type tests	DER evaluation	Commissioning tests
4 General interconnection technical specifications and performance requirements				
4.2 Reference points of applicability	DER System	NR	R	NR
	Composite	NR	R	NR
4.3 Applicable voltages	DER System	NR	R	NR
	Composite	NR	R	NR
4.4 Measurement accuracy	DER System	R	R	NR
	Composite	L	R	NR
4.5 Cease to energize performance requirement	DER System	R	R	D
	Composite	L	R	D
4.6 Control capability requirements				
4.6.1 Capability to disable permit service	DER System	R	R	D
	Composite	L	R	D
4.6.2 Capability to limit active power	DER System	R	R	D
	Composite	L	R	D
4.6.3 Execution of mode or parameter changes	DER System	R	R	D
	Composite	L	R	D
4.7 Prioritization of DER responses	DER System	R	R	D
	Composite	L	R	D
4.8 Isolation device	DER System	R	Design: NR Installation: R	NR
	Composite	L	Design: NR Installation: R	D

Requirement	Compliance at PCC achieved by:	Type tests	DER evaluation	Commissioning tests
4.9 Inadvertent energization of the Area EPS	DER System	R	Design: NR Installation: R	D
	Composite	L	R	D
4.10 Enter service (This is a top-level heading and requirements are specified in the subclauses below.)				
4.10.2 Enter service criteria	DER System	R	NR	NR
	Composite	L	R	D
4.10.3 Performance during entering service	DER System	R	R	D
	Composite	L	R	D
4.10.4 Synchronization	DER System	R	R	D
	Composite	L	R	D
4.11 Interconnect integrity (This is a top-level heading and requirements are specified in the subclauses below.)				
4.11.1 Protection from electromagnetic interference	DER System	R	NR	NR
	Composite	L	NR	NR
4.11.2 Surge withstand performance	DER System	R	NR	NR
	Composite	L	NR	NR
4.11.3 Paralleling device	DER System	R	NR	NR
	Composite	L	NR	NR
4.12 Integration with Area EPS grounding	DER System	NR	R	NR
	Composite	NR	R	NR
5 Reactive power capability and voltage/power control requirements				
5.2 Reactive power capability of the DER	DER System	R	R	D
	Composite	L	R	D
5.3 Voltage and reactive power control	DER System	R	Design: NR Installation: R	NR
	Composite	L	R	D
5.3.2 Constant power factor mode	DER System	R	Design: NR Installation: R	NR
	Composite	L	R	D
5.3.3 Voltage-reactive power mode	DER System	R	Design: NR Installation: R	NR
	Composite	L	R	D
5.3.4 Active power-reactive power mode	DER System	R	Design: NR Installation: R	NR
	Composite	L	R	D
5.3.5 Constant reactive power mode	DER System	R	Design: NR Installation: R	NR
	Composite	L	R	D

Requirement	Compliance at PCC achieved by:	Type tests	DER evaluation	Commissioning tests
5.4 Voltage and active power control (This is a top-level heading and requirements are specified in the subclauses below.)				
5.4.2 Voltage-active power mode	DER System	R	Design: NR Installation: R	NR
	Composite	L	R	R
6 Response to Area EPS abnormal conditions				
6.2 Area EPS faults and open phase conditions	DER System	R	Design: R Installation: NR	D
	Composite	L	R	D
6.3 Area EPS reclosing coordination	DER System	NR	Design: R Installation: NR	NR
	Composite	NR	Design: R Installation: NR	R
6.4 Voltage				
6.4.1 Mandatory voltage tripping requirements	DER System	R	Design: R ^a Installation: R ^b	D
	Composite	L	Design: R ^a Installation: R ^b	D
6.4.2.1 General requirements and exceptions	DER System	R	R	D
	Composite	L	R	D ^a
6.4.2.2 Voltage disturbances within continuous operation region	DER System	R	Design: R ^a Installation: R ^b	D
	Composite	L	R	D ^a
6.4.2.3 Low-voltage ride-through (This is a top-level heading and requirements are specified in the subclauses below.)				
6.4.2.3.2 Low-voltage ride-through capability	DER System	R	R	NR
	Composite	L	R	D ^a
6.4.2.3.3 Low-voltage ride-through performance	DER System	R	R	NR
	Composite	L	R	D ^a
6.4.2.4 High-voltage ride-through (This is a top-level heading and requirements are specified in the subclauses below.)				
6.4.2.4.2 High-voltage ride-through capability	DER System	R	NR	NR
	Composite	L	R	D ^a
6.4.2.4.3 High-voltage ride-through performance	DER System	R	NR	NR
	Composite	L	R	D ^a
6.4.2.5 Ride-through of consecutive voltage disturbances	DER System	R	NR	NR
	Composite	L	R	D ^a
6.4.2.6 Dynamic voltage support (This is a top-level heading and requirements are specified in the subclauses below.)				
6.4.2.6.1 Dynamic voltage	DER System	R	R	NR

Requirement	Compliance at PCC achieved by:	Type tests	DER evaluation	Commissioning tests
support capability	Composite	L	R	D
6.4.2.6.2 Dynamic voltage support performance	DER System	R	R	NR
	Composite	L	R	D
6.4.2.7 Restore output with voltage ride-through (This is a top-level heading and requirements are specified in the subclauses below.)				
6.4.2.7.1 Restore output without dynamic voltage support	DER System	R	R	NR
	Composite	L	R	D
6.4.2.7.2 Restore output with dynamic voltage support	DER System	R	R	NR
	Composite	L	R	D
6.4.2.7.3 Transition between performance operating regions for Category III DER	DER System	R	R	NR
	Composite	L	R	D
6.5 Frequency				
6.5.1 Mandatory frequency tripping requirements	DER System	R	Design: R ^a Installation: R ^b	D
	Composite	L	Design: R ^a Installation: R ^b	D
6.5.2.1 General requirements and exceptions	DER System	R	NR	NR
	Composite	L	R	R
6.5.2.2 Frequency disturbances within continuous operation region	DER System	R	NR	NR
	Composite	L	R	R
6.5.2.3 Low-frequency ride-through (This is a top-level heading and requirements are specified in the subclauses below.)				
6.5.2.3.1 Low-frequency ride-through capability	DER System	R	NR	NR
	Composite	NR	NR	NR
6.5.2.3.2 Low-frequency ride-through performance	DER System	R	NR	NR
	Composite	L	R	R
6.5.2.4 High-frequency ride-through (This is a top-level heading and requirements are specified in the subclauses below.)				
6.5.2.4.1 High-frequency ride-through capability	DER System	R	NR	NR
	Composite	L	R	R
6.5.2.4.2 High-frequency ride-through performance	DER System	R	NR	NR
	Composite	L	R	R
6.5.2.5 Rate of change of frequency (ROCOF) ride-through	DER System	R	NR	NR
	Composite	L	R	R
6.5.2.6 Voltage phase angle changes ride-through	DER System	R	NR	NR
	Composite	L	Design: R Installation: NR	D

Requirement	Compliance at PCC achieved by:	Type tests	DER evaluation	Commissioning tests
6.5.2.7 Frequency-droop (frequency-power) (This is a top-level heading and requirements are specified in the subclauses below.)				
6.5.2.7.1 Frequency-droop (frequency-power) capability	DER System	R	NR	NR
	Composite	L	R	D
6.5.2.7.2 Frequency-droop (frequency-power) operation	DER System	R	NR	NR
	Composite	L	R	D
6.6 Return to service after trip	DER System	R	NR	NR
	Composite	L	R	D
7 Power quality				
7.1 Limitation of dc injection	DER System	R	NR	NR
	Composite	NR	R	NR
7.2 Limitation of voltage fluctuations induced by the DER (This is a top-level heading and requirements are specified in the subclauses below.)				
7.2.2 Rapid voltage changes (RVC)	DER System	NR	Design: R Installation: NR	D
	Composite	NR	Design: R Installation: NR	D
7.2.3 Flicker	DER System	NR	Design: R Installation: NR	D
	Composite	NR	Design: R Installation: NR	D
7.3 Limitation of current distortion	DER System	R	NR	NR
	Composite	L	R	D
7.4 Limitation of overvoltage contribution	DER System	R	R	D
	Composite	L	R	D
8 Islanding				
8.1 Unintentional islanding	DER System	R	NR	NR
	Composite	L	R ^c	R ^d
8.1.2 Conditional extended clearing time	DER System	R	R	NR
	Composite	L	R	R ^d
8.1.3 Area EPS with automatic reclosing	DER System	R	R	NR
	Composite	L	R	R ^d
8.2 Intentional islanding (This is a top-level heading and requirements are specified in the subclauses below.)				
8.2.2 Scheduled intentional islands	DER System	NA	NA	NA
	Composite	L	R	R
8.2.3 Unscheduled intentional islands	DER System	NA	NA	NA
	Composite	L	R	R
8.2.4 Conditions for unscheduled	DER System	NA	NA	NA

Requirement	Compliance at PCC achieved by:	Type tests	DER evaluation	Commissioning tests
transition to intentional island	Composite	L	R	R
8.2.5 Transition of an intentional island from the Area EPS	DER System	NA	NA	NA
	Composite	L	R	R
8.2.6 Reconnection of an intentional island to the Area EPS	DER System	NA	NA	NA
	Composite	L	R	R
8.2.7 Adjustments to DER settings	DER System	NA	NA	NA
	Composite	L	R	R
8.2.8 DER categories for intentional islands	DER System	NA	NA	NA
	Composite	L	R	R
9 DER on distribution secondary grid/area/street (grid) networks and spot networks				
9.2 Distribution secondary grid networks	DER System	NR	R	D
	Composite	NR	R	D
9.3 Distribution secondary spot networks	DER System	NR	R	D
	Composite	NR	R	D
10 Interoperability, information exchange, information models, and protocols				
10.1 Interoperability requirements	DER System	R	R	NR
	Composite	L	R	D
10.2 Monitoring, control, and information exchange requirements	DER System	R	R	NR
	Composite	L	R	D
10.3 Nameplate	DER System	R	NR	NR
	Composite	L	R	D
10.4 Configuration information	DER System	R	NR	NR
	Composite	L	R	D
10.5 Monitoring information	DER System	R	NR	NR
	Composite	L	R	D
10.6 Management information (This is a top-level heading and requirements are specified in the subclauses below.)				
10.6.2 Constant power factor mode parameters	DER System	R	NR	NR
	Composite	L	R	D
10.6.3 Voltage-reactive power mode parameters	DER System	R	NR	NR
	Composite	L	R	D
10.6.4 Active power-reactive power mode parameters	DER System	R	NR	NR
	Composite	L	R	D
10.6.5 Constant reactive power mode parameters	DER System	R	NR	NR
	Composite	L	R	D
10.6.6 Voltage-active power mode parameters	DER System	R	NR	NR
	Composite	L	R	D

Requirement	Compliance at PCC achieved by:	Type tests	DER evaluation	Commissioning tests
10.6.7 Voltage trip and momentary cessation parameters	DER System	R	NR	NR
	Composite	L	R	D
10.6.8 Frequency trip parameters	DER System	R	NR	NR
	Composite	L	R	D
10.6.9 Frequency droop parameters	DER System	R	NR	NR
	Composite	L	R	D
10.6.10 Enter service	DER System	R	NR	NR
	Composite	L	R	D
10.6.11 Cease to energize and trip	DER System	R	NR	NR
	Composite	L	R	D
10.6.12 Limit maximum active power	DER System	R	NR	NR
	Composite	L	R	D
10.7 Communication protocol requirements	DER System	R	NR	NR
	Composite	L	R	D
10.8 Communication performance requirements	DER System	R	NR	NR
	Composite	L	R	D

^aAlign trip settings at DER devices and substation.

^bVerify correct installation settings.

^cIslanding trip time test data can be used to assist in the DER design evaluation line item for 6.3.

^dSome supplemental equipment may require commissioning.

A system design verification shall be made to help ensure that the requirements of 6.2 (for Area EPS faults) have been met. Type tests shall be made to verify the requirements of 6.2 (for individual open phase conditions) of this standard have been met. The Type test (set-up) and certification record shall include each of the specific interconnection transformer vector groups with which the specific DER unit is intended to be interconnected. DER evaluations and/or commissioning tests may also be made to verify the requirements of 6.2 for the DER (for individual open phase conditions) of this standard have been met.

11.3.3 DER that shall meet requirements at the PoC

The test and verification requirements are specified by use of a test requirements matrix (Table 44). This matrix provides a means of traceability between the need to verify a given requirement and the means of verification. These matrices ensure that there is consistency throughout the stages in interconnection process testing and verification for DER that shall meet requirements at the PoC.

This subclause outlines a methodology for testing and verification of DER that may be used to demonstrate conformance at the PoC per Clause 4 through Clause 10 for interconnection and interoperability requirements of this standard. The Area EPS operator may have additional requirements for interconnection.

For DER that shall meet requirements at the PoC per 4.2, Table 44 specifies the test and verification requirements.¹²⁵

The DER unit shall be classified as either fully compliant or partially compliant. Type tests, DER evaluations, and commissioning tests shall be done as indicated in the table for all line items under the appropriate classification.

Table 44—Interconnection test specifications and requirements for DER that shall meet requirements at the PoC

LEGEND	
DER Unit	Individual DER unit is fully compliant at the PoC—no supplemental DER device needed
Composite	Composite of partially-compliant individual DER units that is, as a whole, fully compliant at PoC may need one or more supplemental DER device(s)
NR	Not Required
R	Required
L	Limited type testing is limited to partial compliance of the individual DER unit in order to evaluate the DER unit performance characteristics for later use in the DER evaluation that verifies full compliance of the composite DER at the PoC. The DER unit may not have any compliance at all with certain requirements, leaning on the supplemental equipment to comply.
D	Dependent on DER Design Evaluation
NA	Not Applicable

Requirement	Compliance at PoC achieved by:	Type tests	DER evaluation	Commissioning tests
4 General interconnection technical specifications and performance requirements				
4.2 Reference points of applicability	DER Unit	NR	R	NR
	Composite	NR	R	NR
4.3 Applicable voltages	DER Unit	NR	R	NR
	Composite	NR	R	NR
4.4 Measurement accuracy	DER Unit	R	NR	NR
	Composite	L	R	NR
4.5 Cease to energize performance requirement	DER Unit	R	NR	NR
	Composite	L	R	D
4.6 Control capability requirements				
4.6.1 Capability to disable permit service	DER Unit	R	NR	NR
	Composite	L	R	D
4.6.2 Capability to limit active power	DER Unit	R	NR	NR
	Composite	L	R	D
4.6.3 Execution of mode or parameter changes	DER Unit	R	NR	NR
	Composite	L	R	D
4.7 Prioritization of DER responses	DER Unit	R	NR	NR
	Composite	L	R	D

¹²⁵ The corresponding responsibilities, procedures, requirements, and criteria for the applicable test and verification methods are specified in IEEE Std 1547.1 [B17].

Requirement	Compliance at PoC achieved by:	Type tests	DER evaluation	Commissioning tests
4.8 Isolation device	DER Unit	R	NR	NR
	Composite	L	Design: NR Installation: R	D
4.9 Inadvertent energization of the Area EPS	DER Unit	R	Design: NR Installation: R	D
	Composite	L	R	R
4.10 Enter service (This is a top-level heading and requirements are specified in the subclauses below.)				
4.10.2 Enter service criteria	DER Unit	R	NR	NR
	Composite	L	R	D
4.10.3 Performance during entering service	DER Unit	R	R	D
	Composite	L	R	D
4.10.4 Synchronization	DER Unit	R	R	D
	Composite	L	R	D
4.11 Interconnect integrity (This is a top-level heading and requirements are specified in the subclauses below.)				
4.11.1 Protection from electromagnetic interference	DER Unit	R	NR	NR
	Composite	L	NR	NR
4.11.2 Surge withstand performance	DER Unit	R	NR	NR
	Composite	L	NR	NR
4.11.3 Paralleling device	DER Unit	R	NR	NR
	Composite	L	NR	NR
4.12 Integration with Area EPS grounding	DER Unit	NR	R	NR
	Composite	NR	R	NR
5 Reactive power capability and voltage/power control requirements				
5.2 Reactive power capability of the DER	DER Unit	R	NR	NR
	Composite	L	R	NR
5.3 Voltage and reactive power control (This is a top-level heading and requirements are specified in the subclauses below.)				
5.3.2 Constant power factor mode	DER Unit	R	NR	NR
	Composite	L	R	R
5.3.3 Voltage-reactive power mode	DER Unit	R	NR	NR
	Composite	L	R	R
5.3.4 Active power-reactive power mode	DER Unit	R	NR	NR
	Composite	L	R	R
5.3.5 Constant reactive power mode	DER Unit	R	NR	NR
	Composite	L	R	R
5.4 Voltage and active power control (This is a top-level heading and requirements are specified in the subclauses below.)				
5.4.2 Voltage-active power mode	DER Unit	R	R	NR
	Composite	L	R	R
6 Response to Area EPS abnormal conditions				

Requirement	Compliance at PoC achieved by:	Type tests	DER evaluation	Commissioning tests
6.2 Area EPS faults and open phase conditions	DER Unit	R	Design: R Installation: NR	NR
	Composite	L	R	NR
6.3 Area EPS reclosing coordination	DER Unit	NR	Design: R ^a Installation: NR	NR
	Composite	NR	Design: R Installation: NR	D
6.4 Voltage				
6.4.1 Mandatory voltage tripping requirements	DER Unit	R	Design: R ^b Installation: R ^c	NR
	Composite	L	Design: R ^b Installation: R ^c	NR
6.4.2.1 General requirements and exceptions	DER Unit	R	NR	NR
	Composite	L	R	D
6.4.2.2 Voltage disturbances within continuous operation region	DER Unit	R	NR	NR
	Composite	L	Design: R Installation: NR	D
6.4.2.3 Low-voltage ride-through (This is a top-level heading and requirements are specified in the subclauses below.)				
6.4.2.3.2 Low-voltage ride-through capability	DER Unit	R	NR	NR
	Composite	L	Design: R Installation: NR	D
6.4.2.3.3 Low-voltage ride-through performance	DER Unit	R	Design: R Installation: NR	D
	Composite	L	Design: R Installation: NR	D
6.4.2.4 High-voltage ride-through (This is a top-level heading and requirements are specified in the subclauses below.)				
6.4.2.4.2 High-voltage ride-through capability	DER Unit	R	NR	NR
	Composite	L	Design: R Installation: NR	D
6.4.2.4.3 High-voltage ride-through performance	DER Unit	R	NR	NR
	Composite	L	Design: R Installation: NR	D
6.4.2.5 Ride-through of consecutive voltage disturbances	DER Unit	R	NR	NR
	Composite	L	Design: R Installation: NR	D
6.4.2.6 Dynamic voltage support (This is a top-level heading and requirements are specified in the subclauses below.)				
6.4.2.6.1 Dynamic voltage support capability	DER Unit	R	NR	NR
	Composite	L	R	D
6.4.2.6.2 Dynamic voltage support performance	DER Unit	R	NR	NR
	Composite	L	R	D

Requirement	Compliance at PoC achieved by:	Type tests	DER evaluation	Commissioning tests
6.4.2.7 Restore output with voltage ride-through (This is a top-level heading and requirements are specified in the subclauses below.)				
6.4.2.7.1 Restore output without dynamic voltage support	DER Unit	R	NR	NR
	Composite	L	R	D
6.4.2.7.2 Restore output with dynamic voltage support	DER Unit	R	NR	NR
	Composite	L	R	D
6.4.2.7.3 Transition between performance operating regions for Category III DER	DER Unit	R	NR	NR
	Composite	L	R	D
6.5 Frequency				
6.5.1 Mandatory frequency tripping requirements	DER Unit	R	Design: R ^b Installation: R ^c	D
	Composite	L	Design: R ^b Installation: R ^c	D
6.5.2.2 Frequency disturbances within continuous operation region	DER Unit	R	NR	NR
	Composite	L	NR	NR
6.5.2.3 Low-frequency ride-through (This is a top-level heading and requirements are specified in the subclauses below.)				
6.5.2.3.1 Low-frequency ride-through capability	DER Unit	R	NR	NR
	Composite	L	NR	NR
6.5.2.3.2 Low-frequency ride-through performance	DER Unit	R	NR	NR
	Composite	L	NR	NR
6.5.2.4 High-frequency ride-through (This is a top-level heading and requirements are specified in the subclauses below.)				
6.5.2.4.1 High-frequency ride-through capability	DER Unit	R	NR	NR
	Composite	L	NR	NR
6.5.2.4.2 High-frequency ride-through performance	DER Unit	R	NR	NR
	Composite	L	NR	NR
6.5.2.5 Rate of change of frequency (ROCOF) ride-through	DER Unit	R	NR	NR
	Composite	L	NR	NR
6.5.2.6 Voltage phase angle changes ride-through	DER Unit	R	NR	NR
	Composite	L	NR	NR
6.5.2.7 Frequency-droop (frequency-power) (This is a top-level heading and requirements are specified in the subclauses below.)				
6.5.2.7.1 Frequency-droop (frequency-power) capability	DER Unit	R	NR	NR
	Composite	L	R	D
6.5.2.7.2 Frequency-droop (frequency-power) operation	DER Unit	R	NR	NR
	Composite	L	R	D
6.6 Return to service after trip	DER Unit	R	NR	NR
	Composite	L	R	D
7 Power quality				
7.1 Limitation of dc injection	DER Unit	R	NR	NR
	Composite	L	R	NR

Requirement	Compliance at PoC achieved by:	Type tests	DER evaluation	Commissioning tests
7.2 Limitation of voltage fluctuations induced by the DER (This is a top-level heading and requirements are specified in the subclauses below.)				
7.2.2 Rapid voltage changes (RVC)	DER Unit	NR	Design: R Installation: NR	D
	Composite	NR	Design: R Installation: NR	D
7.2.3 Flicker	DER Unit	NR	Design: R Installation: NR	D
	Composite	NR	Design: R Installation: NR	D
7.3 Limitation of current distortion	DER Unit	R	NR	NR
	Composite	L	R	D
7.4 Limitation of overvoltage contribution	DER Unit	R	R	D
	Composite	L	R	D
8 Islanding				
8.1 Unintentional islanding	DER Unit	R	NR	NR
	Composite	L	R ^d	R ^e
8.1.2 Conditional extended clearing time	DER Unit	R	NR	NR
	Composite	L	R	R ^e
8.1.3 Area EPS with automatic reclosing	DER Unit	R	NR	NR
	Composite	L	R	R ^e
8.2 Intentional islanding (This is a top-level heading and requirements are specified in the subclauses below.)				
8.2.2 Scheduled intentional islands	DER Unit	NR	NR	NR
	Composite	L	R	R
8.2.3 Unscheduled intentional islands	DER Unit	NR	NR	NR
	Composite	L	R	R
8.2.4 Conditions for unscheduled transition to intentional island	DER Unit	NR	NR	NR
	Composite	L	R	R
8.2.5 Transition of an intentional island from the Area EPS	DER Unit	NR	NR	NR
	Composite	L	R	R
8.2.6 Reconnection of an intentional island to the Area EPS	DER Unit	NR	NR	NR
	Composite	L	R	R
8.2.7 Adjustments to DER settings	DER Unit	NR	NR	NR
	Composite	L	R	R
8.2.8 DER categories for intentional islands	DER Unit	NR	NR	NR
	Composite	L	R	R
9 DER on distribution secondary grid/area/street (grid) networks and spot networks				
9.2 Distribution secondary grid networks	DER Unit	NR	R	D
	Composite	NR	R	D

Requirement	Compliance at PoC achieved by:	Type tests	DER evaluation	Commissioning tests
9.3 Distribution secondary spot networks	DER Unit	NR	R	D
	Composite	NR	R	D
10 Interoperability, information exchange, information models, and protocols				
10.1 Interoperability requirements	DER Unit	R	NR	NR
	Composite	L	R	D
10.2 Monitoring, control, and information exchange requirements	DER Unit	R	NR	NR
	Composite	L	R	D
10.3 Nameplate	DER Unit	R	NR	NR
	Composite	L	R	D
10.4 Configuration information	DER Unit	R	NR	NR
	Composite	L	R	D
10.5 Monitoring information	DER Unit	R	NR	NR
	Composite	L	R	D
10.6 Management information (This is a top-level heading and requirements are specified in the subclauses below.)				
10.6.2 Constant power factor mode parameters	DER Unit	R	NR	NR
	Composite	L	R	D
10.6.3 Voltage-reactive power mode parameters	DER Unit	R	NR	NR
	Composite	L	R	D
10.6.4 Active power-reactive power mode parameters	DER Unit	R	NR	NR
	Composite	L	R	D
10.6.5 Constant reactive power mode parameters	DER Unit	R	NR	NR
	Composite	L	R	D
10.6.6 Voltage-active power mode parameters	DER Unit	R	NR	NR
	Composite	L	R	D
10.6.7 Voltage trip and momentary cessation parameters	DER Unit	R	NR	NR
	Composite	L	R	D
10.6.8 Frequency trip parameters	DER Unit	R	NR	NR
	Composite	L	R	D
10.6.9 Frequency droop parameters	DER Unit	R	NR	NR
	Composite	L	R	D
10.6.10 Enter service	DER Unit	R	NR	NR
	Composite	L	R	D
10.6.11 Cease to energize and trip	DER Unit	R	NR	NR
	Composite	L	Design: NR Installation: R	D
10.6.12 Limit maximum active power	DER Unit	R	NR	NR
	Composite	L	R	D
10.7 Communication protocol requirements	DER Unit	R	NR	NR
	Composite	L	R	D
10.8 Communication performance	DER Unit	R	NR	NR

Requirement	Compliance at PoC achieved by:	Type tests	DER evaluation	Commissioning tests
requirements	Composite	L	R	D

^aIslanding trip time test data, from the line item for 8.1 in this table, can be used to assist in the DER design evaluation.

^bAlign trip settings at DER devices and substation.

^cVerify correct installation settings.

^dIslanding trip time test data can be used to assist in the DER design evaluation line item for 6.3.

^eSome supplemental equipment may require commissioning.

A system design verification shall be made to ensure that the requirements of 6.2 (for Area EPS faults) of this standard have been met. Type tests shall be made to verify the requirements of 6.2 (for individual open phase conditions) have been met. The Type test (set-up) and certification record shall include each of the specific interconnection transformer vector groups with which the specific DER unit is intended to be interconnected. DER evaluations and/or commissioning tests may also be made to verify the requirements of 6.2 for the DER (for individual open phase conditions) of this standard have been met.

11.4 Fault current characterization

11.4.1 General

This subclause defines tests and documentation of parameters that are useful in characterizing DER current contributions to Area EPS faults.¹²⁶

11.4.2 Electronically coupled DER

This subclause applies to electronically coupled generation with aggregate rated capacity of 500 kVA or greater. This requirement shall also apply to three-phase systems comprised of three sets of single-phase systems, if the aggregate facility rating at the PCC is 500 kVA or greater. The objective is to determine the controller response of the DER under certain fault conditions. The requirements in this subclause exclude directly connected synchronous and induction generators without active control of rotor current.¹²⁷

The DER operator shall provide to the Area EPS operator oscillographic voltage and current data for all three phases measured during type testing. Sequence impedance characteristics of the external source used during DER type tests shall be provided. The DER shall be type tested for maximum short circuit current levels.

11.4.3 Synchronous and induction generator DER

The data requirements for synchronous and induction generator DER are the nameplate kVA rating, synchronous impedance, negative sequence impedance, zero sequence impedance, transient impedance, and subtransient impedances. The requirements in this subclause exclude induction generators with active control of rotor current.

¹²⁶ The interconnection of DER may impact the equipment and operation of the EPS. System impact studies identify potential problems and allow the Area EPS operator to determine the modifications to the Area EPS facilities that may mitigate potential problems.

¹²⁷ A doubly-fed induction machine is considered to have active control of the rotor current.

Annex A

(informative)

Bibliography

Bibliographical references are resources that provide additional or helpful material but do not need to be understood or used to implement this standard. Reference to these resources is made for informational use only.

- [B1] Accredited Standards Committee C2-2012, National Electrical Safety Code® (NESC®).
- [B2] BDEW Bundesverband der Energie- und Wasserwirtschaft e.V. (German Association of Energy and Water Industries) (2008): Technical Guideline: Generating Plants Connected to the Medium-Voltage Network. Guideline for generating plants' connection to and parallel operation with the medium-voltage network), revised January 2013.
- [B3] Boemer, J. C. (2016): On Stability of Sustainable Power Systems. Network Fault Response of Transmission Systems with Very High Penetration of Distributed Generation. PhD diss. Delft University of Technology, Delft, The Netherlands. Intelligent Electrical Power Grids. Available online at <http://doi.org/10.4233/uuid:78bffb19-01ed-48f9-baf6-ffb395be68a0>.
- [B4] CA Rule 21, California Electric Tariff Rule 21.
- [B5] EPRI White Paper, *Recommended Settings for Voltage and Frequency Ride-Through of Distributed Energy Resources*. Product number 3002006203. May 2015. Available online at <http://www.epri.com/abstracts/Pages/ProductAbstract.aspx?ProductId=000000003002006203>.¹²⁸
- [B6] FERC Docket RM16-8-000, IEEE P1547 Response to FERC NOPR RM16-8 decision on Proposed Changes Requiring Small Generators to Ride-Through System Disturbances. Submitted by IEEE Standards Association (IEEE SA). May 2016.¹²⁹ Available online at https://elibrary.ferc.gov/idmws/file_list.asp?document_id=14461876.
- [B7] FERC Order No. 828. Requirements for Frequency and Voltage Ride-Through Capability of Small Generating Facilities. Final Rule. Docket No. RM16-8-000. FERC. July 21, 2016. Available online at <http://www.ferc.gov/whats-new/comm-meet/2016/072116/E-11.pdf>.
- [B8] IEC 61850-7-420, Communication networks and systems for power utility automation—Part 7-420: Basic communication structure—Distributed energy resources logical nodes.¹³⁰
- [B9] IEC 61850-8-1, Communication networks and systems for power utility automation—Part 8-1: Specific communication service mapping (SCSM)—Mappings to MMS (ISO 9506-1 and ISO 9506-2) and to ISO/IEC 8802-3.
- [B10] IEC 61850-8-2, Communication networks and systems for power utility automation—Part 8-2. Specific communication service mapping (SCSM)—Mapping to Extensible Messaging Presence Protocol (XMPP).
- [B11] IEC TR 61850-80-3, Communication networks and systems for power utility automation—Part 80-3: Mapping to web protocols—Requirements and technical choices.
- [B12] IEC 62351-12, Power Systems Management and Associated Information Exchange—Data and Communications Security—Part 12.
- [B13] IEEE Std 67™, IEEE Guide for Operation and Maintenance of Turbine Generators.^{131, 132}

¹²⁸ EPRI publications are available from the Electric Power Research Institute (<http://www.epri.com>).

¹²⁹ FERC dockets are available from Federal Energy Regulatory Commission (https://elibrary.ferc.gov/idmws/docket_sheet.asp).

¹³⁰ IEC publications are available from the International Electrotechnical Commission (<http://www.iec.ch>) and the American National Standards Institute (<http://www.ansi.org/>).

- [B14] IEEE Std 929™, IEEE Recommended Practice for Utility Interface of Photovoltaic (PV) Systems.
- [B15] IEEE Std 1001™, IEEE Guide for Interfacing Dispersed Storage and Generation Facilities with Electric Utility Systems.
- [B16] IEEE Std 1453.1™, IEEE Guide--Adoption of IEC/TR 61000-3-7:2008, Electromagnetic compatibility (EMC)—Limits—Assessment of emission limits for the connection of fluctuating installations to MV, HV and EHV power systems.
- [B17] IEEE Std 1547.1™, IEEE Standard Conformance Test Procedures for Equipment Interconnecting Distributed Resources with Electric Power Systems.
- [B18] IEEE Std 1547.2™, IEEE Application Guide for IEEE Std 1547™, IEEE Standard for Interconnecting Distributed Resources with Electric Power Systems.
- [B19] IEEE Std 1547.3™, IEEE Guide for Monitoring, Information Exchange, and Control of Distributed Resources Interconnected with Electric Power Systems.
- [B20] IEEE Std 1547.4™, IEEE Guide for Design, Operation, and Integration of Distributed Resource Island Systems with Electric Power Systems.
- [B21] IEEE Std 1547.6™, IEEE Recommended Practice for Interconnecting Distributed Resources with Electric Power Systems Distribution Secondary Networks.
- [B22] IEEE Std 1547.7™, IEEE Guide for Conducting Distribution Impact Studies for Distributed Resource Interconnection.
- [B23] IEEE Std 2030®, IEEE Guide for Smart Grid Interoperability of Energy Technology and Information Technology Operation with the Electric Power System (EPS), End-Use Applications, and Loads.
- [B24] IEEE Std C37.102™, IEEE Guide for AC Generator Protection.
- [B25] IEEE Std C57.12.44™, IEEE Standard Requirements for Secondary Network Protectors.
- [B26] NERC Distributed Energy Resources Task Force Report, *Distributed Energy Resources: Connection, Modeling, and Reliability Considerations*. North American Electric Reliability Corporation (NERC), February 2017. Available online at http://www.nerc.com/comm/Other/essntlrbltysrvckskfrDL/Distributed_Energy_Resources_Report.pdf.
- [B27] NERC PRC-024-2, Standard PRC-024-2 Generator Frequency and Voltage Protective Relay Settings.¹³³
- [B28] NERC Report, *1,200 MW Fault Induced Solar Photovoltaic Resource Interruption Disturbance Report. Southern California 8/16/2016 Event*. North American Electric Reliability Corporation (NERC), June 2017. Available online at <http://www.nerc.com/pa/rmm/ea/Pages/1200-MW-Fault-Induced-Solar-Photovoltaic-Resource-Interruption-Disturbance-Report.aspx>.
- [B29] NERC Variable Generation Task Force Report, *Performance of Distributed Energy Resources During and After System Disturbance. Voltage and Frequency Ride-Through Requirements*. North American Electric Reliability Corporation (NERC), Dec 2013. Available online at http://www.nerc.com/pa/RAPA/ra/Reliability%20Assessments%20DL/IVGTF17_PC_FinalDraft_December_clean.pdf.
- [B30] NERC Special Report, *Potential Bulk System Reliability Impacts of Distributed Resources*. North American Electric Reliability Corporation (NERC), August 2011. Available online at [https://www.nerc.com/pa/RAPA/ra/Reliability%20Assessments%20DL/IVGTF_TF-1-8_Reliability-Impact-Distributed-Resources_Final-Draft_2011%20\(2\).pdf#search=Reliability%20Impacts%20of%20Distributed%20Resources%2E](https://www.nerc.com/pa/RAPA/ra/Reliability%20Assessments%20DL/IVGTF_TF-1-8_Reliability-Impact-Distributed-Resources_Final-Draft_2011%20(2).pdf#search=Reliability%20Impacts%20of%20Distributed%20Resources%2E).
- [B31] NFPA 70®, The National Electrical Code® (NEC®).

¹³¹ The IEEE standards or products referred to in Annex A are trademarks owned by The Institute of Electrical and Electronics Engineers, Incorporated.

¹³² IEEE publications are available from The Institute of Electrical and Electronics Engineers (<http://standards.ieee.org/>).

¹³³ NERC publications are available from the North American Reliability Corporation (<http://www.nerc.com/>).

[B32] NFPA 110, Standard for Emergency and Standby Power Systems.

[B33] NISTIR 7628, Guidelines for Smart Grid Cybersecurity.

Annex B

(informative)

Guidelines for DER performance category assignment

B.1 Introduction

This annex provides guidance to authorities governing interconnection requirements (AGIR) regarding the assignment of performance categories, as defined in this standard, to Distributed Energy Resources (DER) based on attributes such as technology, application purpose, power generation variability, and the specific characteristics of the point of common coupling with the Area EPS.

As proposed in the IEEE P1547 response to FERC NOPR RM16-8 submitted by the IEEE Standards Association in May 2016 [B6], the criteria for assignment of DER performance categories outlined in the informative Annex B may be used as a reference point to partly specify “Good Utility Practice” for specific ride through requirements as required from small generating facilities per FERC Order 828 [B7].

B.2 Background

Rapidly increasing penetration of DER in the electric power system has driven the need for a limited set of specific DER performance characteristics in this standard, particularly with regard to the following:

- Participation of the DER in the voltage and reactive power management of the Area EPS (Clause 5).
- Voltage and frequency disturbance ride-through capabilities necessary to protect *bulk power system* security and Area EPS power quality (Clause 6 and Clause 7).

The inherent abilities of various DER types to achieve these performance attributes differ. In situations where DER penetration is high, basic levels of performance that can be readily achieved by all DER technologies have been deemed insufficient to meet existing bulk system reliability needs, or to address more localized Area EPS power quality issues.¹³⁴ On the other hand, universally requiring high levels of performance that are sufficient to meet BPS reliability and power quality needs in all reasonable situations would, in practice, exclude certain types of DER from interconnection, which is not the intent of this standard.

Often, the DER technologies that would tend to be excluded by uniform minimum performance standards provide unique societal benefits that cannot be provided by technologies that are more readily adaptable to minimum universal electrical performance requirements. An example is DER using synchronous generators. Synchronous generators are inherently limited in their ability to remain connected to the Area EPS during low-voltage (typically fault) events of extended duration.¹³⁵ While synchronous generators possess this inherent electrical limitation, they provide additional benefits such as increased system inertia, dispatchable spinning reserve in most typical synchronous generator applications, and other non-electrical

¹³⁴ This annex intentionally uses qualitative DER penetration levels qualifiers. The impact of DER on frequency and voltage performance of the interconnections and the regional power systems differs significantly and it remains in the responsibility of an AGIR to quantify impactful DER penetration levels.

¹³⁵ Synchronous operation depends on a balance of mechanical power from the prime mover and electrical power to the load (or grid). During a low-voltage event, the electrical power delivered to the Area EPS is inherently reduced, creating a power imbalance that accelerates the rotational speed of the generator. If that imbalance is too great, or persists too long, the machine will lose synchronism. This condition, known as “pole slip,” can potentially cause catastrophic damage to the equipment.

and societal benefits. There are a number of DER applications having positive environmental, energy efficiency, or public safety benefits where synchronous generators are the only practical choice. Examples include combined heat and power applications, conversion of waste methane gas, and backup power to critical facilities.

B.3 Normal and abnormal performance category standard approach

B.3.1 General

Worldwide, DER interconnection standards have tended to stipulate performance requirements through technology-specific standards. This approach has been intentionally avoided in the development of this standard for the following reasons:

- It is inherently discriminatory to demand a greater level of performance from one type or technology of DER simply because it can provide the capability, at a cost, while relieving other technologies of that burden due to the infeasibility to meet the requirement. As a matter of policy, IEEE standards should remain technology-neutral where possible, and should definitely not be discriminatory in nature.
- It is exceedingly difficult to accurately categorize all DER technologies, particularly as new technologies may evolve. For example, doubly fed generators, commonly used in wind turbines, behave in some situations like rotating generators and in other situations like power-electronic inverters.
- DER performance is sometimes governed by the characteristics of the prime mover or primary energy source as much as the power conversion device (i.e., generator or inverter). The inherent tendency of technology-based DER performance standards, as adopted elsewhere, is to categorize by the power conversion device without regard to the limitations on performance imposed by the prime mover or primary energy source.

Tradeoffs between electrical performance limitations and the wider societal benefits offered by a particular DER technology or application type can be made. However, evaluation of such non-electrical factors is outside the scope of this IEEE standard. Therefore, this standard defines performance and capability categories to which DER equipment and systems can be designed and tested. The discretion of how to apply the categories to specific technologies, application purposes, and Area EPS point of common coupling characteristics is left to the AGIR.

Figure B.1 gives a high-level overview of the performance-based category approach, which is summarized as follows:

- The AGIR, which could be state regulators, *bulk power system* operators, or the Area EPS operator would perform a DER impact assessment based on anticipated DER deployment for the future. This assessment would consider technical conditions such as future DER penetration levels, DER power output variability, distribution system characteristics, e.g., fault-induced delayed voltage recovery (FIDVR) issues, feeder configuration and protection, as well as bulk system characteristics, e.g., power reserves or future system inertia. It could also consider non-technical issues such as DER use cases and the broader impacts of DER on the environment, emissions, and sustainability. This analysis could be a starting point for a stakeholder process, initiated and managed by the AGIR, with the ultimate goal of assigning DER performance categories to specific DER (technology) types and application purposes (use cases).
- The DER vendors, e.g., manufacturers of PV inverter or synchronous generators, would analyze the costs associated with meeting certain performance categories for their products. They would also

analyze their market segments, based on the category assignment of AGIRs, and ultimately make decisions on how to design their products.

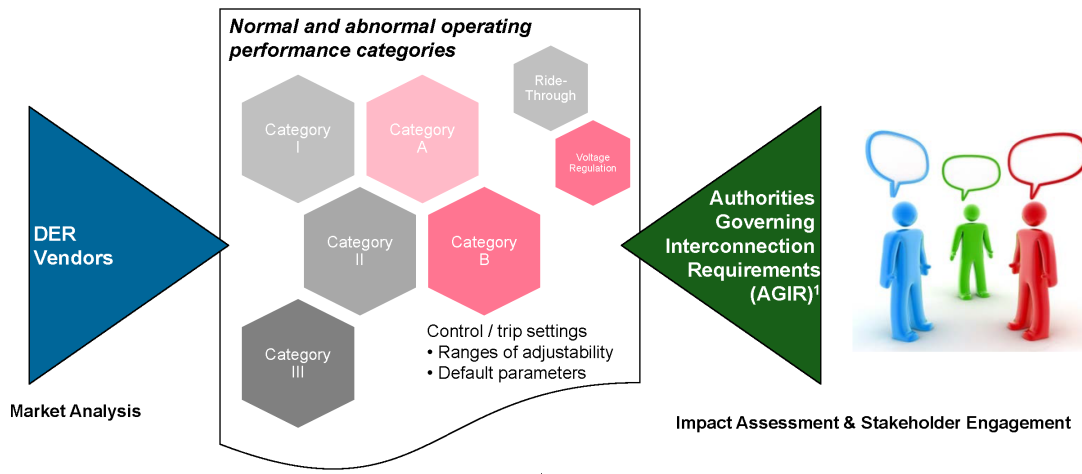

Figure B.1—High-level overview of performance-based category approach

For the application of the standard, the following sets of performance categories are used:

- Categories A and B for voltage regulation performance and reactive power capability requirements ([Clause 5](#))
- Categories I, II, and III for disturbance ride-through requirements ([Clause 6](#))

The performance and capability category levels in [Clause 5](#) and [Clause 6](#) are not inherently tied to each other. Keeping categories for different performance requirements sets de-linked from each other gives the AGIR flexibility to consider the particular characteristics of the DER interconnection.

For example, the AGIR may require less demanding bulk system issues-related requirements (Category I for disturbance ride-through) while still requiring more demanding distribution system issues-related requirements (Category B for voltage regulation) in justified cases. However, for consistency in the levels of performance and capability, it is strongly recommended to pair Category I with Category A, and to pair Category II and Category III with Category B.

The bases and intended purposes for the performance categories defined in this standard are outlined in the following subclauses for information purposes.

B.3.2 Normal performance categories ([Clause 5](#))

B.3.2.1 General

Different characteristics and capabilities for response to voltage variations within the normal operating range are specified in certain parts of [Clause 5](#) for performance Category A, and Category B DER. Under mutual agreement between Area EPS operator and DER operator, requirements other than those specified next are also allowed.

B.3.2.2 Category A

Category A covers minimum performance capabilities needed for Area EPS voltage regulation and are reasonably attainable by all state-of-the-art DER technologies. This level of performance is deemed adequate for applications where the DER penetration in the distribution system is lower, and where the DER power output is not subject to frequent large variations.

B.3.2.3 Category B

Category B covers all requirements within Category A and specifies supplemental capabilities needed to adequately integrate the DER in local Area EPS where the DER penetration is higher or where the DER power output is subject to frequent large variations.

B.3.3 Abnormal performance categories (Clause 6)

B.3.3.1 Category I

Category I is based on minimal *bulk power system* (BPS) reliability needs and is reasonably attainable by all DER technologies that are in common usage today.

The disturbance ride-through requirements for Category I are derived from the German Association of Energy and Water Industries (BDEW [B2]) standard for medium voltage synchronous generators and is one of the most widely applied standards in Europe. Many synchronous generator manufacturers are currently designing products to meet the requirements of this standard.

Category I disturbance ride-through performance, however, is not consistent with the reliability standards imposed on *bulk power system* generation resources. High penetrations of DER having only Category I capabilities could be detrimental to *bulk power system* reliability, but limited penetration of this category would not have a material negative impact. It should be noted that penetration, with regard to *bulk power system* reliability impacts, should be measured on a regional or bulk system-wide¹³⁶ basis, and local distribution system penetration levels are not typically of particular relevance.

B.3.3.2 Category II

Category II performance covers all BPS reliability needs and coordinates with the existing BPS reliability standard, NERC PRC-024-2 [B26], developed to avoid adverse tripping of bulk system generators during system disturbances. Additional voltage ride-through capability is specified for DERs, beyond mandatory voltage ride-through defined by NERC PRC-024-2 [B26], to account for the potential for fault-induced delayed voltage recovery on the distribution system, due to distribution load characteristics.

B.3.3.3 Category III

Category III provides the highest disturbance ride-through capabilities, intended to address integration issues such as power quality and system overloads caused by DER tripping in local Area EPS that have very high levels of DER penetration. This category also provides increased *bulk power system* security by further reducing the potential loss of DER during bulk system events. These requirements are based on the California Rule 21 [B4] Smart Inverter requirements.

¹³⁶ Synchronous interconnections, such as the Eastern Interconnection, ERCOT, WECC, are examples of bulk systems in this context.

B.4 Performance category assignment

B.4.1 General

Prior to assignment of categories, the needs of the bulk system on a wide basis and regional basis, as well as the local Area EPS, possibly down to feeder level, should be considered.

B.4.2 DER attribute groupings

Before performance level categories can be assigned, a systematic categorization of DER types should be devised. The following list of DER attributes that should be considered is non-exhaustive:

- Power conversion device technology, such as synchronous generator, voltage-source inverter, induction generator, doubly fed generator, etc.
- Primary power source, such as solar, biogas, fossil fuel, hydro, wind, energy storage device, etc.
- Prime mover or type of primary energy source conversion, such as reciprocating engine, turbine, fuel cell, etc.
- DER application purpose, such as combined heat and power (cogeneration), merchant power generation, backup generation for critical facilities, retail customer self-supply, waste fuel recovery, etc.
- Factors related to the point of common coupling into the Area EPS, such as high-penetration feeders, areas of high regional DER penetration, dedicated distribution feeders, relative system strength, PCC location on a specific feeder, etc.
- Inherent output variability of the DER type.
- Other attributes.

The AGIR should identify DER type groupings that consider the previous attributes and any other attributes that may be deemed appropriate. A full matrix of type groupings that considers separately each and every one of the attributes above would be unwieldy and impractical to administer. Therefore, discretion should be applied to combine attributes in a meaningful way to reduce the number of DER types to a manageable level, while also providing adequate means to discriminately apply the performance category assignments in a way that balances total societal benefits and impacts.

B.4.3 Performance category assignment criteria

B.4.3.1 Assignment of normal performance categories (Clause 5)

To deal with power quality issues caused by increasing DER penetration, especially of variable-generation DER, the majority of the DER should have Category B performance. However, DER connected to a PCC that is relatively close to the substation as well as non-variable-generation DER may have less impact on the distribution system voltage than DER that are connected close to the end of a feeder or DER with power output that is subject to frequent large variations. In those cases, it is reasonable to interconnect a limited amount of DER capacity that is limited to Category A voltage regulation performance and reactive power capability.

When making the assignment of performance categories to DER types, it is recommended that the AGIR consider the following questions:

- Is it impractical for the given DER type to be designed to meet Category B?
- Is the power output of the DER constant and not subject to frequent large variations?
- Is the rating of the DER, relative to the distribution system short-circuit strength at the point of common coupling, small such that the DER does not have significant impact on distribution voltage?
- Is the projected penetration of all DER types allowed to interconnect with Category A capability and performance relatively small compared to the total load level on the particular feeder?

Depending on the answers to these questions, the assignment of performance Category A to the particular DER type grouping may be appropriate from the standpoint of power quality issues caused by increasing DER penetration. In certain cases, however, the AGIR might consider imposing higher levels of voltage regulation performance and reactive power capability requirements, but may also consider the overall benefit to impact ratios.

Particularly in areas of high DER penetration and where the predominate DER types involve inherent power output variability (e.g., solar PV), requirements for DER to meet Category B performance may be necessary.

B.4.3.2 Example normal performance category assignment

The categorization of DER types and the assignment of voltage regulation performance and reactive power capability categories based on criteria that are at least partially subjective, is complex. To facilitate this process, an example decision tree for the performance category assignment is provided in [Figure B.2](#). While this figure is an example, it provides a recommended starting point for determining DER attribute groupings and performance category assignments.

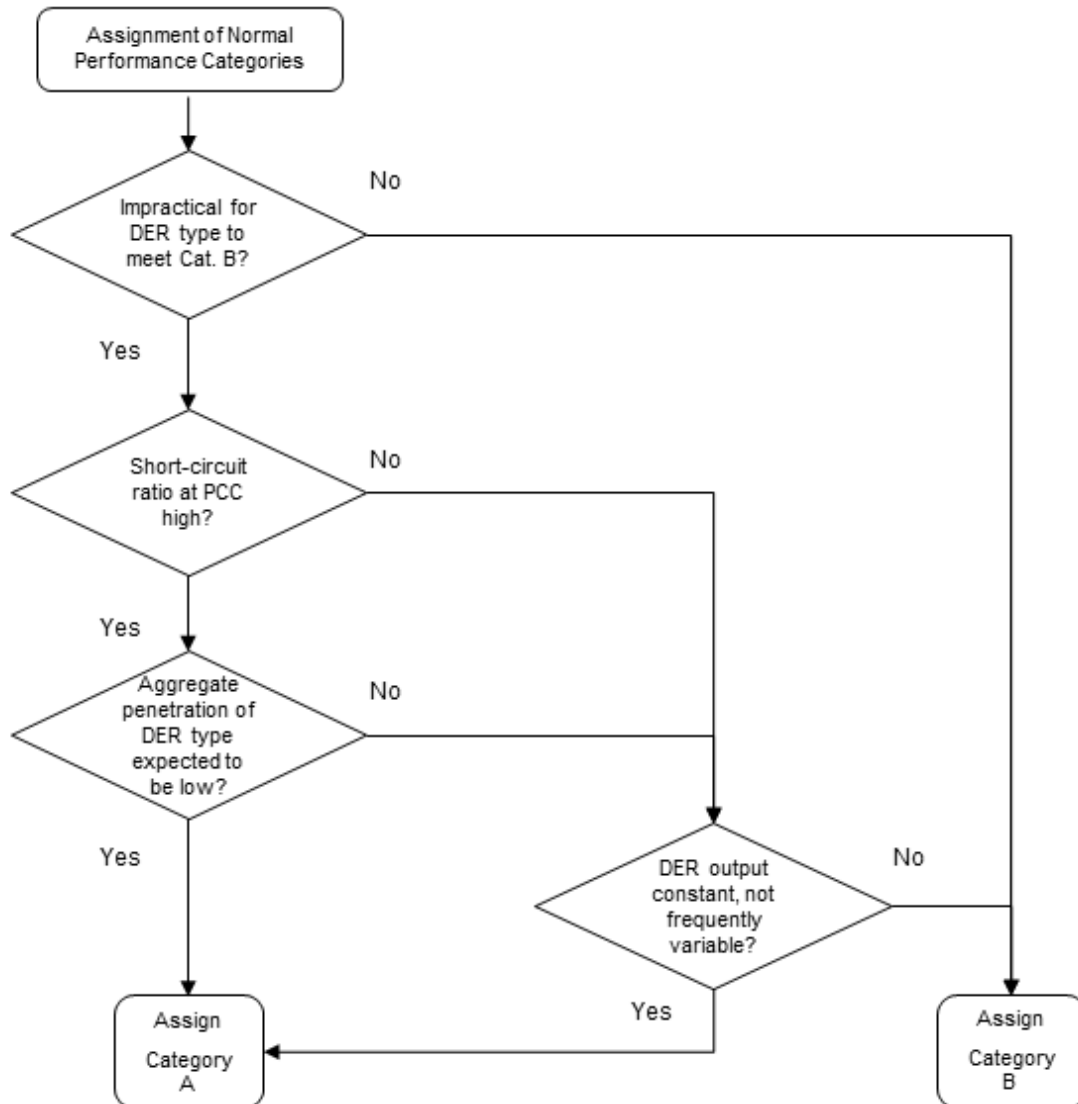

Figure B.2—Example decision tree for normal performance category assignment (Clause 5)

B.4.3.3 Assignment of abnormal performance categories (Clause 6)

To preserve the security of the *bulk power system*, the majority of DER should have Category II disturbance ride-through performance. However, there are notable exceptions when disturbance ride-through performance Category I and III should be applied instead. When the total societal benefits are evaluated, it is reasonable to interconnect a limited amount of DER capacity that is limited to Category I performance and that have other non-electrical benefits.

When making the assignment of performance categories to DER types, it is recommended that the AGIR consider all of the following questions:

- Is it impractical for the given DER type to be designed to meet Category II or III performance?
- Is there a societal benefit provided by the DER type that offsets the potential adverse impact on system security due to reduced capability?
- Is the projected penetration of all DER types allowed to interconnect with Category I performance relatively small compared to the total load level in the region?

NOTE—Bulk electrical system reliability impacts are related to the total amount of DER in a relatively large region, and penetration levels at individual distribution systems or circuits are not of particular relevance.

If the answer to each of the previous is “yes,” then assignment of performance Category I to the particular DER type grouping is appropriate from the standpoint of *bulk power system* reliability. In all other cases, the AGIR should assign performance Category II or might consider imposing even higher levels of performance requirements such as Category III, but may also consider the overall benefit to impact ratios.

In areas of particularly high DER penetration and where nuisance tripping of DER could cause voltage collapse or system overloads, requirements for DER to meet Category III performance may be necessary.

Even within such high-penetration regions, it may be reasonable to allow a limited amount of DER with Category I or II performance capabilities that provide unique benefits. An example could be a bio-gas generator that provides consistent power output in a distribution system that also has very high solar PV penetration.

B.4.3.4 Example abnormal performance category assignment

The categorization of DER types and the assignment of disturbance ride-through performance categories based on criteria that are at least partially subjective, is complex. To facilitate this process, an example performance category assignment grid is provided in [Table B.1](#). While this table is an example, it provides a recommended starting point for determining DER attribute groupings and performance category assignments. It is quite possible that an AGIR may also need to define an “all other” application purpose (i.e., column) to accommodate applications not foreseen or otherwise addressed.

Table B.1—Example abnormal performance category assignment grid¹³⁷

DER type		DER application purpose						
		Retail self generation	Combined heat and power	Waste fuel recovery	Renewable energy	Merchant generation ^a	Critical backup ^b	Peak shaving
		A	B	C	D	E	F	G
1	Engine or turbine driven synchronous generator	Category I	Category I	Category I	Category I	Category I	Category I	Category I
2	Wind turbines (all types)	Category II	N/A	N/A	Category II	Category II	N/A	N/A
3	Inverters sourced by solar PV	Category II ^c	N/A	N/A	Category II ^c	Category II ^c	N/A	N/A
4	Inverters sourced by fuel cells	Category I	Category I	Category I	Category I	Category II	Category I	N/A
5	Synchronous hydrogenerators	Category I	N/A	N/A	Category I	Category I	Category I	N/A
6	Other inverter applications	Category II	Category II	Category II	Category II	Category II	Category II	N/A
7	Inverters sourced by energy storage	Category II	N/A	N/A	N/A	Category II	Category II	Category II
8	Other synchronous generators	Category I	Category I	Category I	Category I	Category I	Category I	N/A
9	Other induction generators	Category II	Category II	Category II	Category II	Category II	Category II	Category II

^aMerchant generation in this table is intended to characterize DER facilities installed for the express purpose of exporting power, and is not intended to imply only FERC-jurisdictional generation or other regulatory definitions.

^bOnly applies to critical backup generation interconnected to the Area EPS for the purposes of periodic testing. If backup generation is also used for merchant generation or other purposes, the performance requirements of those purposes apply.

^cCategory III should be required where DER penetration on a distribution feeder exceeds [% VALUE TO BE SPECIFIED BY AGIR], or on the distribution system supplied from a given distribution substation bus exceeds [% VALUE TO BE SPECIFIED BY AGIR].

¹³⁷ The purpose of this table is to provide a recommended starting point for determining DER attribute groupings and performance category assignments. The table is not intended to suggest any equipment capability.

Annex C

(informative)

DER intentional and microgrid island system configurations

C.1 Introduction

Figure C.1, from IEEE Std 1547.4-2011 [B20], shows examples of different kinds of islands incorporating DER. The *intentional island interconnection device* (IID) is used to create the island, as described in 6.2 of IEEE Std 1547.4-2011 [B20]. For example, CB3 may be opened to create the “Circuit Island” in Figure C.1, and there are five DERs within the “Circuit Island”. Those five DERs may have five individual PCCs, or less than five through aggregation. None of the five DER breakers can serve as the IID in this example. On the other hand, each of those DERs could participate in more than one of the example islands shown. Furthermore, whenever the substation feed is available those DERs can also participate in the non-island mode.

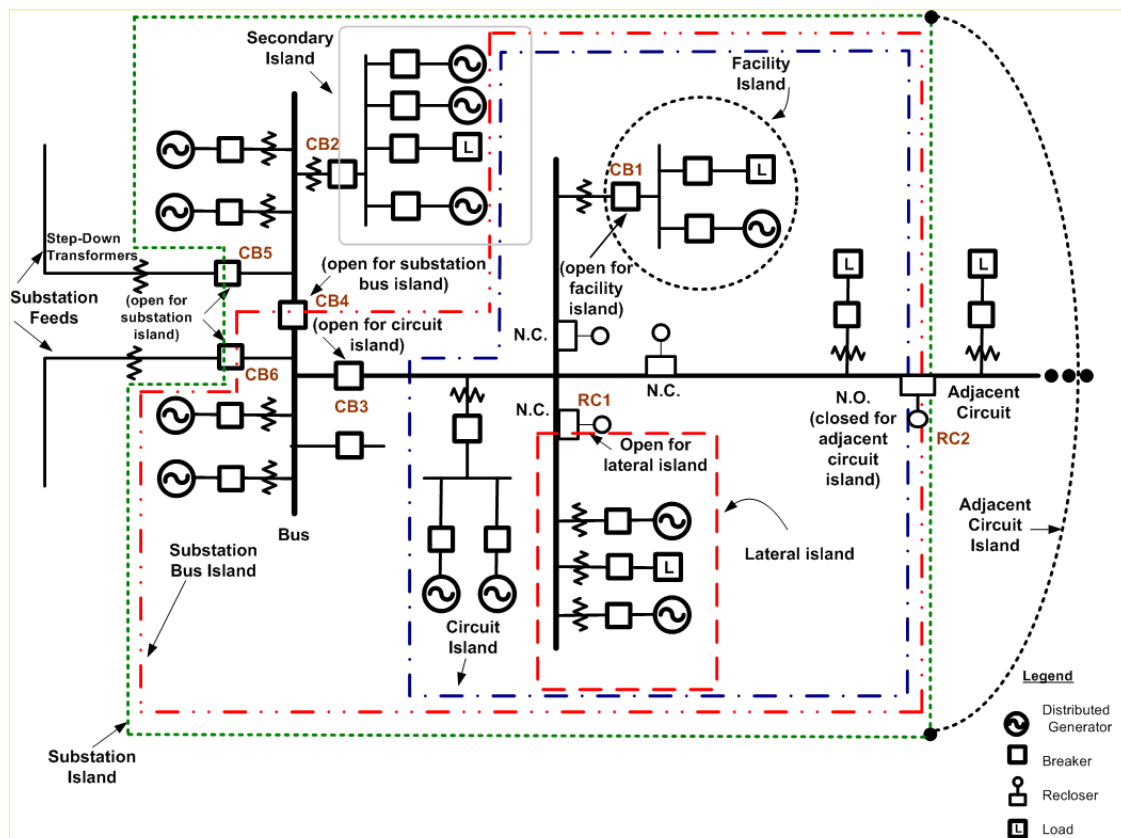

Figure C.1—Examples of DR island systems from IEEE Std 1547.4-2011

This standard is concerned only with the PCC interconnection. The same reasoning applies with example *intentional islands* including microgrids; the *intentional island* or microgrid interface will often not be the same as the PCC interconnection.

Furthermore, this standard is not concerned with *intentional island* or microgrids that operate only as a Local EPS. For example, the “Facility Island” in [Figure C.1](#) is excluded from the scope of this standard, except when CBI closes for the local DER to participate in the “Circuit Island,” the “Substation Bus Island,” or the “Substation Island.”

C.2 Connecting DER not designed for intentional island or microgrid operation

The following examples outline *intentional island* or microgrid implementations where a DER not designed for *intentional island* or microgrid operation may be allowed to participate by the *intentional island* operator (IIO) or microgrid operator (MO):

- A generator is able to provide the maximum steady-state load in the *intentional island* or microgrid island (MI), and has the speed of response to buffer the power transients of the DER not designed for microgrid operation.
- Energy storage is implemented to buffer the power transients of the DER not designed for *intentional island* or microgrid operation.
- Existing hardware experiments or system operation has proven system stability.
- Simulation studies prove system stability.
- A device has been fitted that disconnects the DER, not designed for *intentional island* or microgrid operation, if outside of an acceptable frequency and voltage window. The system has been proven to be stable, with the disconnection device.

These examples are provided for guidance only; it is the responsibility of the IIO or MO to ensure the desired quality of service in the *intentional island* or microgrid.

Annex D

(informative)

DER communication and information concepts and guidelines

D.1 Introduction

This annex provides additional informative information about the interoperability and communications content in the standard.

D.2 General principles

D.2.1 General

This subclause outlines the general principles used to guide the interoperability and communications content.

D.2.2 Scope

The approach taken for interoperability and communication support in this standard is to specify only the DER functional requirements for communication at the DER interface. It is considered beyond the scope of this standard to specify any requirements related to network technologies that may be used to interface with the *local DER communication interface*.

The interoperability and communication content in this standard is based on the functionality in the standard that specifies settings with a *range of allowable settings*. The purpose of the *local DER communication interface* is to allow all the settings information to be read and written through the interface providing remote adjustability. Monitoring of some measurement and status information is also specified.

D.2.3 Standardized local DER communication interface

A set of protocols have been identified in the normative text that satisfy the requirement for communication support. Each option provides different capabilities inherent in the stack. It is intended that the standardized communication capability of a DER be the basis for a more comprehensive communication solution based on the requirements of a DER installation and other appropriate standards.

It is not mandated that the standardized *local DER communication interface* be used for any DER installation. Proprietary communication interfaces may be developed and used to interface to a DER but the standardized *local DER communication interface* shall always be an available option. The intent is to provide grid stability by offering support for a standardized communication option if a proprietary option is no longer functional for any reason.

Figure D.1 and Figure D.2 show examples of the use of standardized and custom interfaces. In both cases, the IEEE 1547 interface option shall be present. The examples also illustrate the interface that is addressed by this standard and the interfaces that are out of scope.

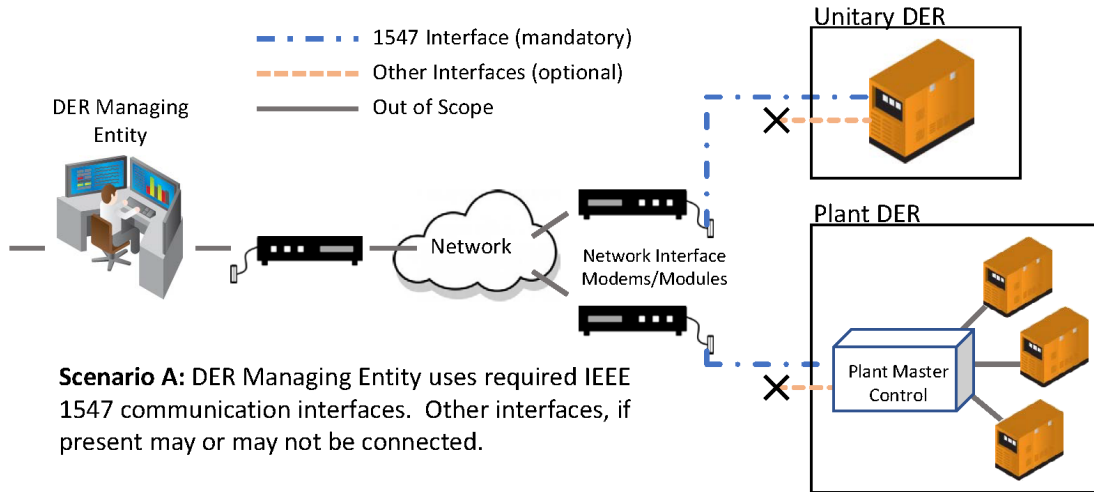

Figure D.1—DER using standardized local DER communication interface

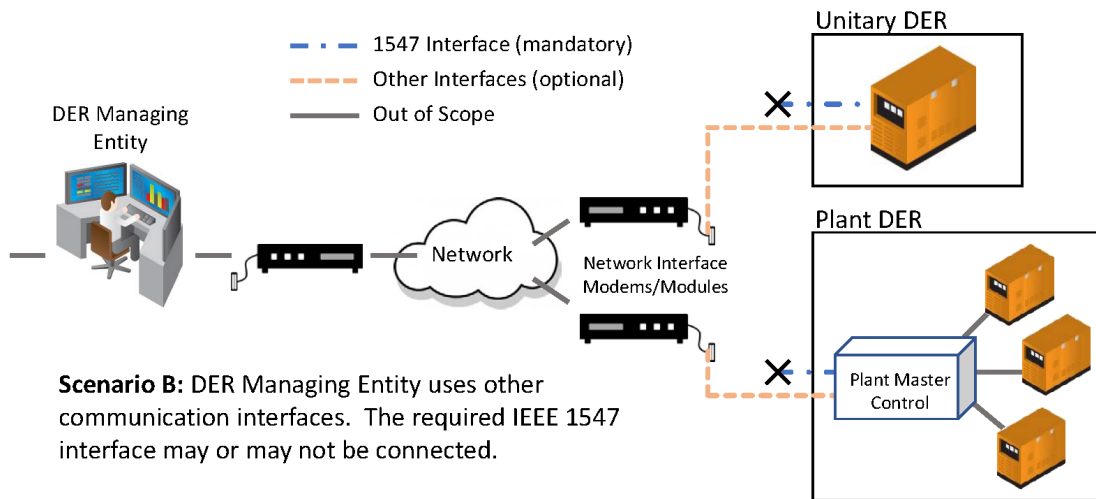

Figure D.2—DER using custom interface

D.2.4 Information model harmonization

In many cases, more than one protocol stack is used to transfer the information between the DER and the managing entity. It is important that information models in each protocol stack be harmonized to maintain the correct meaning of the information being transferred. This harmonization can be facilitated by using industry standard ways of representing certain types of information. The use of piecewise linear curves is an example of information representation that is supported across different protocol information models. This consideration has influenced the choice of information representation in this standard.

D.3 Communication protocols

D.3.1 General

This subclause provides additional detail about the specific protocols that are identified as a standardized interface and other relevant protocols that may be additionally supported.

D.3.2 IEEE Std 2030.5 (SEP2)

IEEE Std 2030.5 provides support for monitoring and control of DER devices. The standard defines the mechanisms for exchanging application messages, the exact messages exchanged including error messages, and the security features used to protect the application messages.

D.3.3 IEEE Std 1815 (DNP3)

IEEE Std 1815 is used to interface to DER devices, often used by utility supervisory control and data acquisition (SCADA) systems. Several specific IEEE 1815 application notes have been developed to support monitoring and control of DER devices.

D.3.4 SunSpec Modbus

The SunSpec Alliance specifies standard Modbus-based information models to support monitoring and control of DER devices.

D.3.5 IEC 61850

IEC 61850-7-420 [B8], specifies the information models to support monitoring and control of DER devices. IEC 61850-7-420 [B8] provides guidelines on the DER functions. IEC 61850-8-2 [B10] defines a standardized protocol based on Internet protocols, and IEC TR 61850-80-3 [B11] provides guidance on the use of web protocols for data exchange.

D.4 Cyber security

D.4.1 DER security requirements

The security requirements associated with DER entail both local physical access and remote network access. The level of security required is proportional to the risk associated with a breach of the system and potential impact on other parts of the system.

The risk profile evaluation associated with different use cases can involve many factors such as the ones listed in the following subclauses.

D.4.2 DER physical security

This standard does not address the requirements associated with physical security of DER systems.

D.4.3 DER front panel security

DER devices often provide front panels to allow interaction by an operator with the DER. This standard does not address the requirements associated with front panel behavior or security.

D.4.4 DER network security

The networks used to connect DER to remote managing entities, and the cyber security requirements of these networks, are out of scope of this standard. DER integration networks will likely be of many kinds and technologies and will use a variety of cyber security mechanisms that evolve over the life of the DER. For this reason, a modular approach has been taken in this standard, excluding the DER network requirements from scope and only specifying the *local DER communication interface*.

D.4.5 Local DER communication interface security

D.4.5.1 General

When a DER is capable of exchanging information through a *local DER communication interface*, consideration should be given to protecting access to DER through that interface. A DER is just like any other system where a malicious or uninformed actor can have an adverse effect on the system.

This standard does not mandate any specific cyber security requirements at the DER interface for at least the following reasons: scope of this standard, scope and complexity of cyber security requirements, system architecture flexibility, and testability.

An additional set of standards may be required to properly address the cyber-physical security requirements of system(s) containing DER and possible requirements specific to the *local DER communication interface*.

D.4.5.2 Scope

Cyber security is a system-wide issue requiring a system-wide solution. This standard specifies the base functionality of a DER including the capability of exchanging specific information over a *local DER communication interface*. This standard cannot correctly address system level issues and should not constrain reasonable system solutions.

D.4.5.3 System architecture

There are many different networking and security scenarios in which a DER may be deployed.

The organization responsible for maintaining the reliability and security of the communications path to the DER must also be able to perform regular maintenance, upgrades, and changes to the network components, including the protocol and cyber security mechanisms.

It is possible to couple a secure networking device with a DER providing an open interface to provide a secure communications path to the DER. Such secure networking devices are common in the utility industry for critical infrastructure integration such as voltage regulators, switches, and capacitors. These networking devices can be designed such that access to the open interface at the DER does not allow access to other devices connected on the same network.

It is important for low-cost DER to be able to be coupled with different networking technologies that may change over the life of the DER. Each networking technology may have different security requirements and solutions.

Non-standardized security features implemented in a DER may make it harder to secure the overall system by requiring workarounds to provide access.

Providing advanced networks for secure DER integration is a science and specialization of its own and DER manufacturers may or may not have this expertise or desire to enter the networking business.

A single network may integrate many different DER types, models, and brands and yet the network provider may need a singular cohesive approach to cyber security system-wide.

DER system software is often a monolithic implementation that does not facilitate tracking and updating based on ongoing changes in the network security arena.

DER manufacturers may stop support for a model or go out of business making it difficult or impossible to fix/update the DER.

D.4.5.4 Testability

Any clause that contains a “shall” declaration shall be able to be tested in IEEE Std 1547.1 [B17]. This is one of the guiding principles for determining what is in scope for the normative content of this standard.

It is difficult to specify meaningful test procedures for general non-standardized requirements.

What types of protections can be provided to assist in preventing unauthorized use of a *local DER communication interface* while providing system design flexibility?

One option is to have the *local DER communication interface* disabled by default and to only enable it through a password-protected front panel interface. This would prohibit access through the *local DER communication interface* until a secure network device is attached. The nature of the physical security and properties of the connection is out of scope for this specification.

D.5 Related standards

D.5.1 IEC 62351-12

IEC 62351-12, Power Systems Management and Associated Information Exchange—Data and Communications Security—Part 12 contains resilience and security recommendations for power systems with distributed energy resources (DER) cyber-physical systems.

D.5.2 IEEE Std 1547.2

IEEE Std 1547.2 [B18] provides technical background and application details to support the understanding of IEEE Std 1547.¹³⁸

¹³⁸ At the time of the publication of this standard, IEEE Std 1547.2-2008 is the most recent version of IEEE Std 1547.2 [B18]. This version, however, is inconsistent with the requirements of this version of IEEE Std 1547 and has limited usefulness.

IEEE Std 1547.2 [B18] facilitates the use of IEEE Std 1547 by characterizing the various forms of distributed resource technologies and the associated interconnection issues. Additionally, the background and rationale of the technical requirements are discussed in terms of the operation of the distributed resource interconnection with the electric power system. Presented in the document are technical descriptions and schematics, applications guidance, and interconnection examples to enhance the use of IEEE Std 1547.

D.5.3 IEEE Std 1547.3

IEEE Std 1547.3 [B19] provides guidelines for monitoring, information exchange, and control for distributed resources (DR) interconnected with electric power systems (EPS). The 2007 version requires an update to address current security issues and capabilities that affect high penetrations of DER.

This document facilitates the interoperability of one or more distributed resources interconnected with electric power systems. It describes functionality, parameters, and methodologies for monitoring, information exchange, and control for the interconnected distributed resources with (or associated with) electric power systems. Distributed resources include systems in the areas of fuel cells, photovoltaics, wind turbines, microturbines, other distributed generators, and distributed energy storage systems.

D.5.4 IEEE Std 2030[®]

IEEE Std 2030 [B23] is an umbrella standard that provides standardized, transparent and systems level guidelines for interoperability between Power, Communications, and Information Systems.

It was the first standard to be created jointly by the three IEEE Societies: Power and Energy Society, Communications Society, and the Computer Society.

It defines the SmartGrid Interoperability Reference Model™ (SGIRM™), which organizes all the functions and interconnections of a Smart Grid in terms of three separate interoperability architecture perspectives (IAPs). The three IAPs primarily relate to logical, functional considerations of power systems, communications interfaces, and IT data flows for smart grid interoperability:

- Power systems IAP (PS-IAP): The emphasis of the power system perspective is the production, delivery, and consumption of electric energy, including apparatus, applications, and operational concepts. This perspective defines seven domains common to all three perspectives: bulk Generation, transmission, distribution, service providers, markets, control/operations, and customers.
- Communications technology IAP (CT-IAP): The emphasis of the communications technology perspective is communication connectivity among systems, devices, and applications in the context of the Smart Grid. The perspective includes communication networks, media, performance, and protocols.
- Information technology IAP (IT-IAP): The emphasis of the information technology perspective is the control of processes and data management flow. The perspective includes technologies that store, process, manage, and control the secure information data flow.

D.5.5 NISTIR 7628

NISTIR 7628 [B33], Guidelines for Smart Grid Cybersecurity, provides additional guidelines for smart grid cyber security that may be applicable to DER deployment.¹³⁹

¹³⁹ NIST publications are available from the National Institute of Standards and Technology (<https://www.nist.gov/>).

Annex E

(informative)

Basis for ride-through of consecutive voltage disturbances

E.1 Introduction

This annex is informative. It is intended to help readers understand the requirements in 6.4.2.5 by use of illustrative figures.

Note that this standard allows an unlimited number of multiple consecutive voltage disturbances that DER are required to ride through within a single disturbance “set,” as long as the cumulative duration of all the disturbances in this set does not exceed the maximum required ride-through duration for the respective voltage disturbance severity (and performance category). The standard also requires that DER ride through several of these sets occurring consecutively within a certain time frame. Each voltage disturbance set may correlate to voltage disturbances during a reclosing for a particular sustained fault, intermittent fault activity, or oscillatory voltage triggered by response and recovery of directly-coupled (synchronous or induction) generators to a fault. The several distinct sets may correlate to several unrelated faults occurring within a short time frame or subsequent reclosing event where the reclosing delay is greater than the time separating sets, as would be typical for transmission system faults. The specification for the consecutive voltage disturbance ride-through requirements were derived from typical transmission and primary distribution protection practices and transmission system dynamic behavior.

E.2 Faults, fault protection, and reclosing

The most typical faults on transmission, sub-transmission, and primary distribution power systems are the result of, or result in, “short-circuits” between two or more system phases or between any system phase(s) and a neutral or a grounded part. These short-circuits—unintended, low-impedance, shunt connections—appear in many forms. At the EHV (greater than 300 kV) transmission level comprising the backbone of the *bulk power system*, common causes of faults are insulator contamination, insulator physical failures, switching surges, supporting structure failures, wildfires, and operational errors (e.g., failure to remove personal protective ground jumpers prior to re-energization). Lightning is rarely a cause for EHV line faults, but HV transmission lines do experience lightning-related faults. At the primary distribution and sub-transmission voltage levels the common causes of faults are direct lightning strikes or lightning-induced flashovers, tree branches falling across energized conductors, animals bridging the gap between energized conductors and the grounded parts they are standing on, failures of insulating components or other equipment failures.

Whatever the form of these short-circuits, they have the following two significant effects:

- They cause high-magnitude “fault” current to flow, because the short-circuit bypasses the normal, high-impedance, shunt connections of loads or other equipment connected between the phases, neutral or ground.
- They cause a disturbance in the normal voltage levels, because they change the voltage-divider relationship between the normally low-impedance series paths from sources to loads and the normally high-impedance shunt connections of those loads and other shunt devices.

The high-magnitude currents resulting from a short-circuit fault usually are orders of magnitude above the current-carrying capability of power system equipment, and must be stopped quickly before significant damage is done. Also, the resulting collapse of voltage due to transmission faults eliminates or greatly reduces the ability to transmit power, thus threatening the stability of the *bulk power system*. The use of

current differential or impedance detection relaying represents the vast majority of protection employed on transmission systems and in substations against damage from these fault currents. At the EHV transmission level, more sophisticated communication-based protection schemes are used to provide greater detection speed, reliability, selectivity, and security. On primary distribution systems, overcurrent protection is predominantly used. This fault protection is implemented on the transmission lines, substation transformers, and primary distribution circuits between sources and loads, since these are the paths that the high-magnitude current takes directly to a fault if one should occur. These types of protection react to abnormal current or impedance conditions, and the response is usually to cause an opening of the series path to the fault, interrupting the fault current (e.g., through the tripping of a breaker or the operation of a fuse). However, depending on the location of the faulted section, this action can also disconnect the normal flow of power through the power system to the loads beyond the open-circuit that is created.

Utility engineers attempt to apply fault protection devices and relaying to maximize the reliability and speed of detecting and interrupting faults (dependability) while minimizing the number of system elements or customers also interrupted (selectivity) and the chances of an unintended operation (security). This is usually achieved by applying fault protection at as many locations as possible, such as at every transmission line terminal or distribution tap, but applying it in such a way that only the protection for the faulted section operates first. This results in having to coordinate the operation of many protection devices in series along fault current pathways, commonly by selecting zones of protection with deliberately limited overlap, by employing directional discrimination, and by selecting different response time characteristics where protection zones overlap. The response time characteristics determine the speed at which that protection responds to faults in different protection zones or at different levels of current. By applying proper choices of fault protection with coordinated response time characteristics, a reasonable degree of dependability versus security can be achieved between multiple devices along the fault current pathway.

All sources connected on a section of the power system that suffers a fault are expected to *cease to energize* and trip from the rest of the power system by the operation of whatever fault protection is applied. This includes DER on the faulted section, either through their own detection and response to the fault, or through their detection of the resulting unintended island resulting from the operation of the power system fault protection. The DER response is covered in the mandatory tripping requirements of the standard.

While the path of the high-magnitude current caused by a short-circuit fault is restricted to the series paths between the sources and the fault, the voltage disturbances (e.g., voltage dips) caused by a short-circuit fault will be experienced by all devices or equipment connected in close proximity to the fault,¹⁴⁰ even if not on the faulted section. Examples include wide-area voltage disturbances caused by faults on transmission systems, and localized voltage disturbances caused by faults on distribution systems. The extent of the system that can experience these disturbances can range from just the small nearby portion of a single distribution circuit affected by a fault on an adjacent section of the circuit, to an entire interstate region affected by a high-voltage transmission fault. In these cases, if the voltage disturbance is not severe enough or does not last long enough, DER on these portions of the system are required to “ride-through” these disturbances and remain in operation as described in 6.4.2.

An additional aspect of fault protection on utility power systems is that many short-circuit faults are temporary. Most typically, temporary fault is caused by a flashover across an insulator or open-air gap that does no permanent damage, and will cease to exist once the current has been interrupted to clear the resulting arc. Such flashovers are typically caused by transient overvoltages related to lightning strikes or (at the EHV transmission level) switching transients. At the distribution level, temporary faults are also caused by a tree branch or an animal that falls off or is blasted clear after making initial contact with energized conductors. Because temporary faults often make up a sizeable share of the types of faults that occur on power systems, attempts are often made to quickly re-energize the disconnected portion of the power system once the interruption by fault protection has taken place. This practice is known as automatic reclosing. It is commonly performed by reclosing relays controlling circuit breakers or, commonly on

¹⁴⁰ This proximity is in an electrical context relative to the impedance network around the location of the fault, rather than a geographical context.

distribution systems, by reclosers (devices distinct from breakers, but similar in function for this discussion).

Reclosing is the application of a finite number of automatic closures (reclosures) of the breaker or recloser in a brief window of time to re-energize the faulted section of the system. If the fault was temporary and no longer exists upon re-energization, then the fault protection has nothing to respond to and electric service or transmission path is restored with no further action. If the fault is persistent or re-ignites, the fault protection will cause the breaker or recloser to trip again. This tripping and reclosing will happen as many times as the number of selected reclosing attempts applied for that device. If the device continues to trip beyond the number of selected reclosures, it will cease any further attempts and go into a “lockout” state. If the device recloses and does not trip again within a selected “reset” time, it will revert back to its normal pre-fault state and start a brand new reclosing sequence the next time it trips for a fault.

Faults at the transmission level, followed by unsuccessful reclosing attempts, appear as multiple consecutive undervoltage events. (In some situations, the system response to fault clearing may also result in multiple periods of overvoltage as well.) These consecutive voltage disturbances may affect DER over a wide geographic area.

There are two significant consequences to DER from the application of automatic reclosing at the distribution level. First, for situations where the DER trips due to a fault on the section to which they are connected, that tripping shall occur prior to the first reclosing attempt to re-energize the section. Second, for situations where DER rides through a voltage disturbance due to a fault on a different section, the DER shall ride through a series of multiple consecutive voltage disturbances due to the re-appearance of that fault upon each reclosure in the selected reclosing sequence.

The series of multiple consecutive voltage disturbance experienced by the DER, whether from transmission or distribution system faults, can be characterized as repeating periods of abnormal voltages during the times that the fault is present, separated by periods of relatively normal voltages during the times that the fault is disconnected or not active. Examples of what the DER may experience are illustrated in [Figure E.1](#), [Figure E.2](#), and [Figure E.3](#) for three different scenarios.¹⁴¹

¹⁴¹ Note that [Figure E.1](#), [Figure E.2](#), and [Figure E.3](#) give only three examples of what can be a whole spectrum of possibilities of multiple consecutive voltage disturbance severities, durations, number of occurrences, and the timing between them.

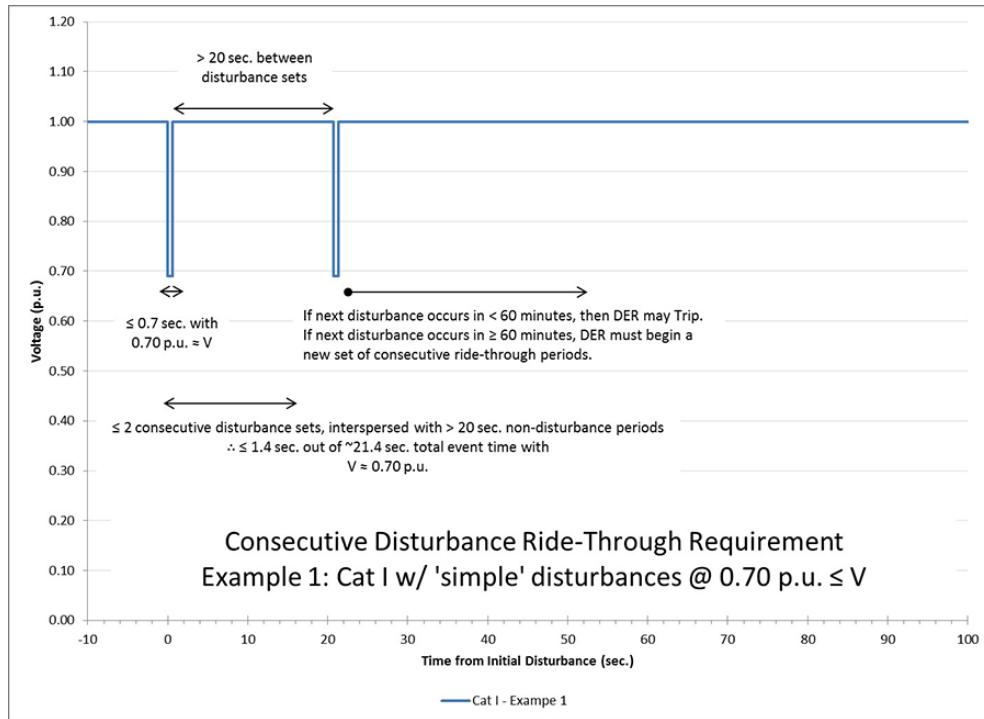

Figure E.1—Consecutive disturbance ride-through requirement, Example 1 for Category I

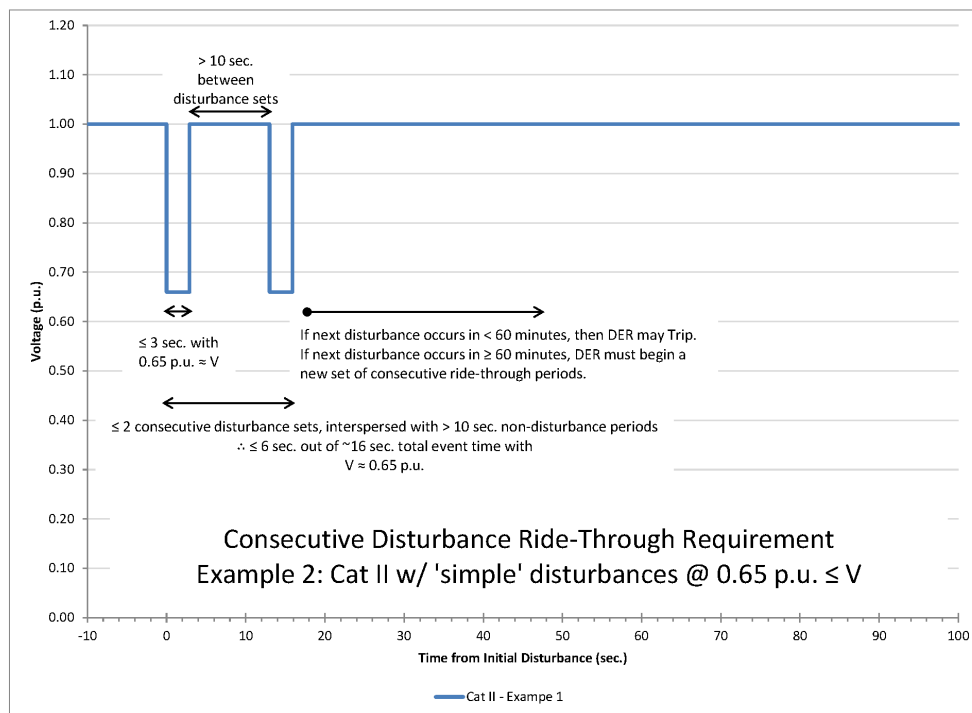

Figure E.2—Consecutive disturbance ride-through requirement, Example 2 for Category II

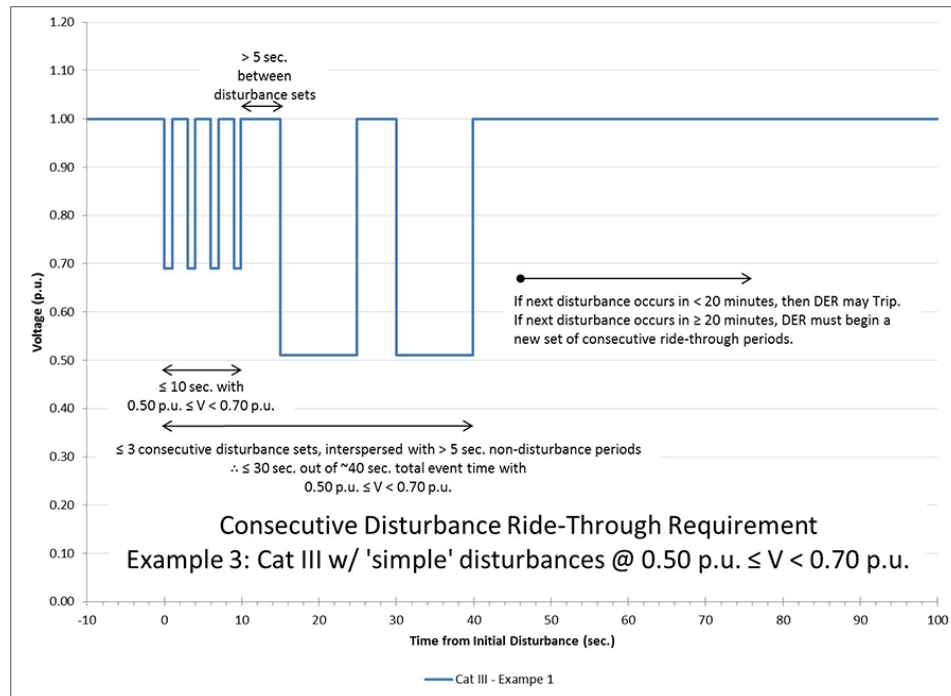

Figure E.3—Consecutive disturbance ride-through requirement, Example 3 for Category III

In the examples in [Figure E.1](#), [Figure E.2](#), and [Figure E.3](#), note the differences in the severity and durations of the abnormal voltages (periods during active fault) and the differences in the number and duration of periods of relatively normal voltages in between (periods where fault is not active). The differences in the severity of the abnormal voltages experienced at a particular DER are due to the impedance of the fault that is occurring, the relative location of the fault, the DER, and other sources on the electric system, and the impedance matrix of the entire power system network. Obviously, these conditions are different for each fault that may occur, and for each DER experiencing the disturbances associated with any of those faults. The differences in the durations of the abnormal voltages are due to the different operating times of the applied fault protection in response to the conditions to which it is exposed. For faults on transmission systems and within substations, the typical current differential, directional comparison, and impedance (distance) protection schemes have high-speed or short, fixed, incremental response times, usually of less than one second and rarely longer than two seconds, and largely independent of the fault current magnitude (but rather the protection zone in which the fault occurs). For simpler time-overcurrent protection, different fault durations are caused not only by different time-current response selections at different protection installations, but also because different levels of fault current will exist for different faults (and thus different response times at the same installation), again due to different fault impedances and system impedances to different fault locations. Finally, the number and duration of periods of relatively normal voltages are due to the selected number of reclosing attempts and the selected reclosing interval times (open times) between each reclosure.

Where automatic reclosing is applied, common selections for a reclosing sequence include 1, 2, or 3 reclosing attempts, corresponding to a series of 2, 3, or 4 voltage disturbances for a persistent fault. Different reclosing equipment may offer even more possible reclosing attempts, but the selection of more than three attempts is not as common. A wide range of reclosing interval times (open times) is usually available for selection, from an “instantaneous” reclosure on the first attempt to mere fractions of a second between reclosures to many seconds between reclosures. Transmission reclosing delays are typically 30 s or longer except where “high speed” reclosing is used with a delay of approximately 0.5 s. Delays longer than 1 s but less than 30 s are not typically used at the bulk transmission level as there is risk of aggravating dynamic oscillations.

At the distribution level, not all reclosing devices have selectable reclosing interval times, hydraulically controlled reclosers being a prime example. Where reclosing interval times are selectable, common selections are approximately 0.2 s to 30 s, although there is much more variation here depending on type of power system (e.g., transmission, distribution, in cross-country right-of-way or along public streets), types of faults typically experienced on that system (e.g., lightning, tree-related), and different utility philosophies and practices.

E.3 Unrelated faults

Another scenario of power system faults that can occur causing multiple consecutive voltage disturbances is when several different faults occur at different locations within an area and within a relatively short window of time. Rather than resulting from multiple reclosures into the same fault, this scenario of multiple different faults may be triggered by a large weather-related event hitting an area, such as numerous lightning strikes during a thunderstorm, severe wind events including tornados or hurricanes, or at the peak of an ice storm.

E.4 Intermittent faults

A third scenario of power system faults that can occur causing multiple consecutive voltage disturbances is an intermittent arcing fault. This type of “sputtering” fault may arc and extinguish itself multiple times without causing any fault protection to operate, either due to high fault impedance resulting in low fault currents that go undetected, or due to relatively rapid self-extinguishing before the fault protection has had enough time to respond. In many cases, this type of fault can continue in this way for a long time, sometimes burning clear and other times eventually evolving into a sustained short-circuit fault. This type of fault may occur at the distribution voltage level, but does not occur at transmission voltage levels.

E.5 Voltage oscillations

The disruption of power flow from generation sources to loads caused by transmission faults cause the synchronous generators in the system to accelerate or decelerate such that their electrical angle with respect to an ideal fundamental-frequency reference is shifted from its pre-fault steady-state value. When the fault is cleared, the generator angles swing to the original value, if the system configuration remains unchanged, or to a new steady-state value if lines, loads, or sources are removed in the process of clearing the fault. Similar to a pendulum displaced from its resting position, the angles do not go to the post-fault values and stop, but rather oscillate with a period of a fraction of a second to several seconds. The resulting system oscillations cause the magnitude of the voltage throughout the system to be modulated at this low frequency. Modulation of distribution substation voltage by the dynamic behavior of the transmission system is reflected down to the voltages experienced by DER connected to the distribution system. As a result, DER PCC voltage magnitudes will tend to oscillate after the clearing of a transmission fault, and these oscillations may cause the voltage to repeatedly transition between the normal and abnormal (potentially including both high- and low-voltage periods) a number of times over a period of a number of seconds. These oscillations typically will dampen out within ten seconds. From the DER perspective, the transitions from normal to abnormal voltage might appear as multiple disturbances. This standard addresses this by specifying ride-through on a cumulative time duration basis. A given dynamic event should be all within one disturbance set, and the DER must ride through up to the total duration specified in terms of severity and DER category.

Annex F

(informative)

Discussion of testing and verification requirements at PCC or PoC

The requirements of this standard apply either at the PCC or the PoC, depending on the aggregate nameplate DER rating and the average annual load in the Local EPS. Where requirements apply at the PoC, equipment type testing will be sufficient to verify conformance with most requirements, in most cases. However, for DER facilities, i.e., Local EPS that are large enough so that requirements apply at the PCC, equipment testing should be supplemented by additional compliance verification measures such as the DER evaluation and further commissioning tests defined in [Clause 11](#). The same holds for any DER that use supplemental DER devices to meet the requirements of this standard. The concept of combined type test and DER evaluation is summarized in [Table F.1](#).

Table F.1—High-level test and verification requirements when type tests are performed for DER unit(s) and not for DER system(s)

IEEE Std 1547 requirement XYZ		Applicability of requirements	
		Point of DER connection (PoC)	Point of common coupling (PCC)
DER capability and conformance	Full No Supplemental DER device needed	Type test + Basic commissioning test	Type test + Basic DER evaluation
	Partial One or more Supplemental DER device(s) needed	Type test(s) + Detailed DER evaluation + Detailed commissioning test	Type test(s) + Detailed DER evaluation + Detailed commissioning test

DERs should meet the general requirements for full and partial conformance testing and verification as follows (illustrated in [Figure F.1](#)):

- a) For DER that meet requirements at the PoC per [4.2](#) and that are fully compliant with all requirements of this standard without the use of a supplemental DER device, DER should be type tested. A DER evaluation and commissioning test should not be required for compliance to this standard, except if [Table 44](#) requires an evaluation or commissioning test. DER that are type tested with the use of a supplemental device are permitted as well.
- b) For DER that meet requirements at the PoC per [4.2](#) and that are partially compliant with the requirements of this standard and that comply with all requirements of this standard in combination with supplemental DER device(s), DER should be type tested and a DER evaluation and commissioning test should be performed.
- c) For DER that meet requirements at the PCC per [4.2](#), for both full and partial compliance, DER should be type tested and a DER evaluation and commissioning test should be performed.
- d) Combinations of DER unit(s) and supplemental DER device(s) forming a system that are type tested as a DER system should not require a DER evaluation or commissioning test except if [Table 43](#) or [Table 44](#) requires DER evaluation or commissioning test.
- e) In all other situations, a detailed DER evaluation and detailed commissioning test should be required.

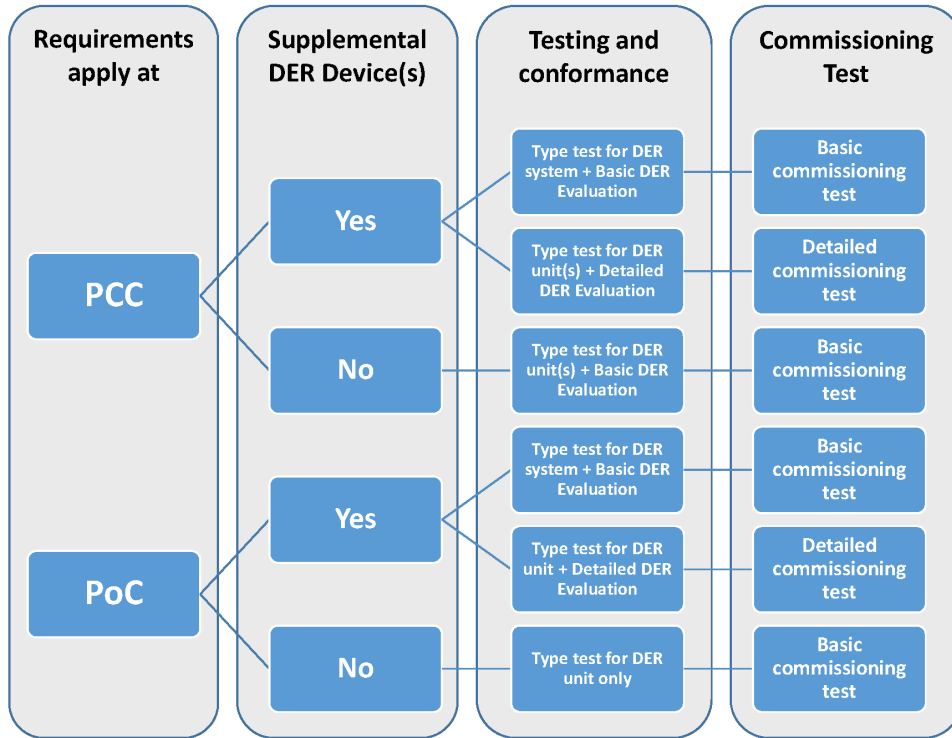

Figure F.1—Interconnection test specifications and requirements concept

DERs should meet the specific requirements for full and partial conformance testing and verification as specified in 11.3.2 and 11.3.3 by assignment of test and verification methods to the interconnection and interoperability requirements of this standard in form of a test matrix (an example of this is illustrated in Figure F.2).

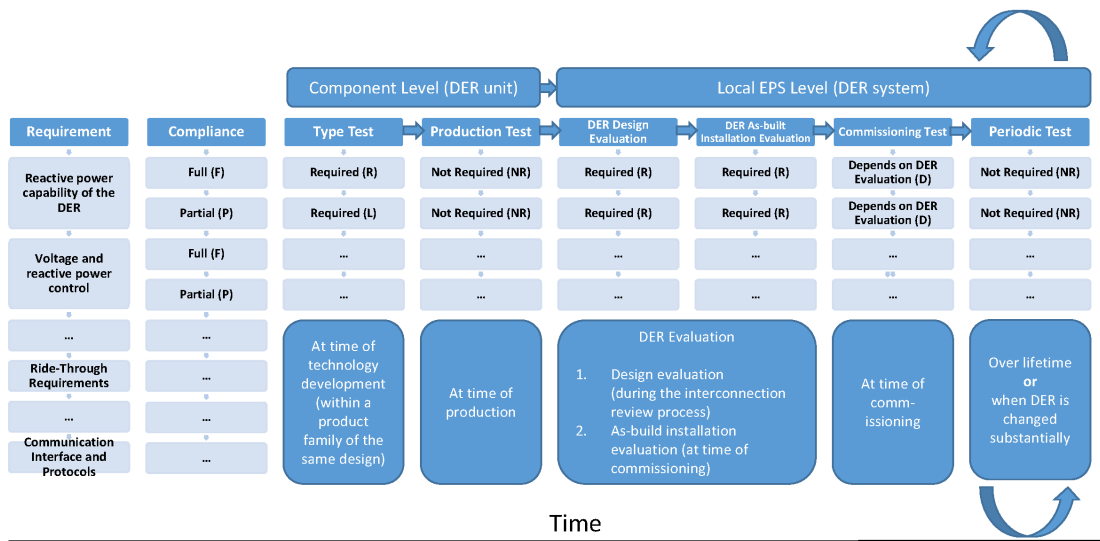

Figure F.2—Assignment of interconnection test specifications and requirements in test requirement matrix (Example)

Annex G

(informative)

Power quality (PQ) clause concepts and guidelines

G.1 Introduction

This annex provides additional information about power quality ([Clause 7](#)). It outlines the general principles and approach applied to update PQ requirements for DER in IEEE Std 1547. While there is growing body of experience related to distributed generation, almost all the previous standards development for power quality have been related to loads and not generators. A key consideration, and challenge, in setting PQ requirements for DER is performance dependence on the frequency response and relative capacity at the PCC. This is particularly true for voltage-related limits like RVC and flicker depending on the relative capacity of the PCC, and for production of harmonic currents depending on the harmonic impedance at the PCC. Short-term overvoltage related to the DER often depends on PCC loading and grounding details. There are potential interactions between the DER and the grid that may not be easy to predict in a study or remove from the certification process. Most of the discussions in this annex address these interactions relative to setting power quality limits.

G.2 Rapid voltage change (RVC) limits

IEC 61000-4-30:2015 defines RVC as a quick transition in rms voltage occurring between two steady-state conditions, and during which the rms voltage does not exceed sag/swell thresholds (10% above or below nominal voltage). Alternatively, IEEE Std 1453-2015 defines RVCs as changes in fundamental frequency rms voltage over several cycles. Both standards recognize RVC as an event that may not be captured by either steady-state or flickermeter measurements, yet may need to be considered for compatibility of end-use equipment and the electric grid.

On the end-user-side, beyond lighting, incompatibilities can manifest in torque transients on motor loads. On the utility-side, there have been incompatibilities between DER and distribution operating equipment such as voltage regulators, and involving reclosures and capacitors. In this context, RVC is included as a DER requirement. Some causes of rapid voltage changes include start-ups, inrush currents, and switching operation of equipment such as capacitor banks and transformers. An example of an RVC caused by transformer energization is shown in [Figure G.1](#).

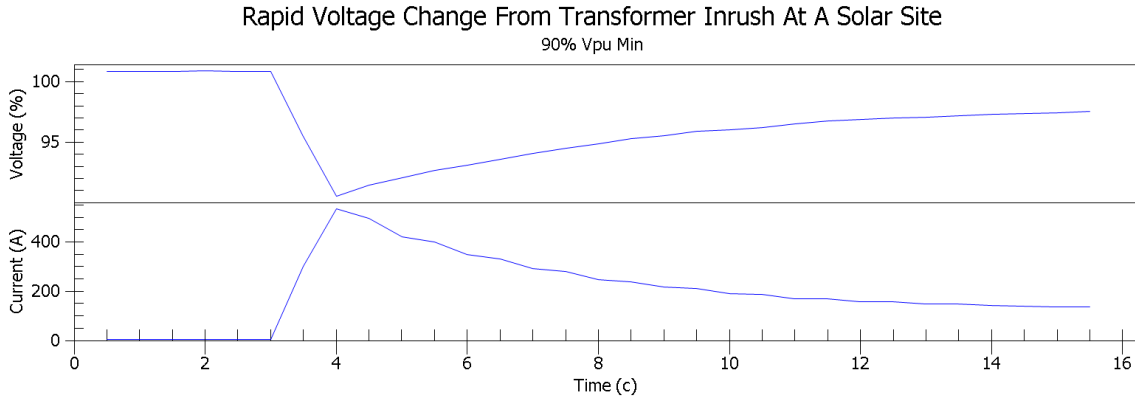

Figure G.1—Example rapid voltage change at 23 kV from transformer energization

The concern with transformer energizations associated with DER is not one-time events like plant commissioning, but if transformer energizations occur frequently.

System planning levels for RVCs are provided in [Table G.1](#) adopted from IEEE Std 1453. The levels are defined in terms of maximum voltage deviation $\Delta V/V$ and the number of changes over time. It is important to note that the “system design planning levels” in this table are intended to represent aggregate limits of all sources of RVC at a point of evaluation (PCC or PoC). Since IEEE Std 1547 applies to DER, the most-strict limit of 3%, was adopted, applying a rationale to reserve some of the system capacity for other fluctuating installations, whether those installations are loads or DER. For purposes of individual DER performance evaluation, IEEE Std 1547 includes the $\Delta V/\%$ and a ramp rate that specifies a one-second time period. This individual DER limit is intentionally more specific than the planning level RVC definitions in IEEE Std 1453.

Table G.1—System design planning level for RVCs (IEEE Std 1453)

Number of changes (<i>n</i>)	$\Delta V_{\max}/V$ %	
	≤ 35 kV	> 35 kV
$n \leq 4$ per day	5–6	3–5
$n \leq 2$ per hour and > 4 per day	4	3
$2 < n \leq 10$ per hour	3	2.5

In setting planning limits for aggregate RVC, the application of [Table G.1](#) for screening or studies has some practical limitations. One limitation is that the DER rapid change performance is not likely known for inputting into prediction calculations. Various DER RVC performances are not expected to be documented during certification. For larger plants, it may be good practice to document and record plant energization, including waveforms, during commissioning. This can be useful if there are interactions and compatibility problems after commissioning.

Also, related to aggregate RVC limits, some planners will assume a step-voltage change at the PCC as if all DER connected to an Area EPS simultaneously have a 100% change in output power, from fully off or fully on. While this worse case is sometimes used in planning, its application to interconnection decisions is excluded in IEEE Std 1547. The rationale for exclusion is that the likely reason for all DER to trip simultaneously is in response to a grid event that takes voltage or frequency beyond ride-thru limits. Since the grid is outside normal operating limits in this case, it is inappropriate to apply an RVC limit for such a scenario.

Other tripping or power change scenarios would likely have less $\Delta V/V$ because of diversity. The number of changes per minute is also not predicable with various cases and sources of RVC. Therefore, specific

design and operating environment of the DER should be considered to determine expected aggregate performance tests. Unexpected individual DER malfunctions may cause field problems and will also be difficult to predict in screening or studies. If there is a dispute about cause and effect, DER or grid, then field measurements and application of IEC/TR 61000-3-7 allocation methods may be helpful.¹⁴²

G.3 Flicker limits

Flicker is the subjective impression of fluctuating luminance caused by voltage changes over a period of time, even if individual changes are not observed. Assessment methods for flicker, caused by highly fluctuating loads such as arc furnaces and welding are described in IEEE Std 1453. These methods are also defined in IEC/TR 61000-3-7. Included within this IEEE recommend practice is a table of indicative planning levels of flicker for different voltage levels, [Table G.2](#). These levels are intended to account for the aggregate of fluctuating installations and are typically the basis for allocating emission limits to individual facilities using summation laws in the IEC document. Also, methods are provided to address transfer from HV to MV and between different PCCs. The allocation of emission limits to individual facilities (denoted as E_{Pst} and E_{Plt}) are set so that aggregate effects do not cause overall flicker at any PCC to exceed the adopted planning level.

Table G.2—Recommended planning levels (IEEE Std 1453)

	Flicker planning levels	
	MV	HV-EHV
L_{Pst}	0.9	0.8
L_{Plt}	0.7	0.6

Techniques normally used for fluctuating loads are applied in this standard to voltage fluctuations caused by fluctuating power generation. The limits for an individual DER facility are specified in [7.2.3](#). Based on the IEC method, allocations of emission limits to a DER are determined as a fraction of the planning level aggregate allocation. This allocation depends on the agreed capacity of the DER relative to the total available grid capacity at the point of evaluation. Specific calculations for this allocation at both MV and HV are provided in the IEC document. If the agreed capacity of the DER is relatively small compared to the grid capacity at the point of evaluation then a minimum allocation of flicker is provided in [Table 25](#).

A key concept here, similar to RVC limits, is that IEEE Std 1547 addresses individual flicker limits and not the aggregate system performance, which is addressed by the recommended planning levels. Also, it is important to recognize that all these flicker limits have been developed based on basic 60 W incandescent lamps. Lamps of lower wattage may have more noticeable lamination changes with the same voltage environment. New types of lighting products generally perform better relative to flicker performance; however, there are exceptions.

In setting DER flicker requirements, consideration was given to the probability of producing voltage fluctuations and the likelihood of flicker complaints based on empirical or field experience to date. With exceptions, most properly functioning DER are not expected to produce pulsating power outputs that cause flicker complaints. For example, the range of known wind and solar resource variations (frequency and rate of change of the input power) have not been sufficient to result in flicker complaints. Also, other properly functioning DER such as gas-fired IC engines, fuel cells, or micro-turbines should not be naturally fluctuating sources prone to cause flicker. In these cases, screening for flicker, or attempting to predict it in a study, are not usually warranted.

On the other hand, certain power conversion technologies, such as particular wind turbine designs, have been known to cause flicker. Generally, these characteristics will be apparent either from certification, lack of certification, or in data required to be submitted in the application to interconnect. For example, IEC

¹⁴² Users can also refer to IEEE Std 1453.1 [\[B16\]](#) since it is an adoption of the IEC technical report.

61400-21 defines flicker coefficients for certain types of wind turbines and provides methods to predict (screen or study) for potential flicker based on the grid characteristics at a PCC.

Despite best practices in processing DER applications, screening, studies, physical interconnection, and commissioning, unexpected field problems can happen. Flicker measurement (defined in IEC 61000-4-15) and analysis has proven useful in differentiating when a site is not functioning properly if there are unexpected interactions with the grid. The specifics on how to address field problems, determine responsibility, and allocate grid capacity are covered in IEC/TR 61000-3-7.

G.4 Current distortion limits

In this standard only current distortion limits are defined. The methodology for setting current distortion limits and for distortion measurement are adopted from IEEE Std 519. There are a few intentional, and notable, differences. The first is a change from total harmonic distortion (THD) limits, used in 2003, to total rated current distortion (TRD). The reason for this change is to capture inter-harmonics in the total distortion calculation. This method is described in a footnote in the normative requirements. The second difference from IEEE Std 519 is regarding the limits on even harmonics. The technical basis for tighter limits (i.e., 25% of odd harmonic limits) for even harmonics in IEEE Std 519 was researched. The key concern is the DC offset effect of even harmonics that have the potential to cause mis-operation of electronic switching by impacting zero crossing and other control logic. Practically, this DC offset effect is mainly caused by the 2nd harmonic and the effect of higher order harmonics diminishes rapidly. Additionally, the tighter limits for even harmonics for the higher order harmonics are found to fall outside the specified accuracy of PQ meters. Therefore, in this document, the limits for the higher order (8th and higher) harmonics have been relaxed to be the same as those for corresponding odd harmonics and the limits for the 2nd harmonic have not been relaxed at all. However, a stepped approach was taken for the 4th and the 6th and they have been relaxed to 50% and 75% of the corresponding odd harmonic limits respectively. It may be noted that limits for overall distortion have not been relaxed at all to act as the overall check on the distortion.

Voltage distortion limits are not defined for the DER and the current distortion limits are intended to be exclusive of harmonic currents due to harmonic voltage distortion present in the Area EPS without the DER connected. In the 2003 version of IEEE Std 1547, voltage harmonic tests were specified as an alternative performance measure, specifically for synchronous generator DER. The rationale for excluding voltage distortion limits in the case of synchronous generator DER in this standard are as follows:

A voltage distortion limit may be defined in the test procedure for synchronous generators. However, such a test definition is not considered to be a performance limit.

The meaning of voltage distortion limits of DER while operating grid-connected is unclear and could be misapplied. Defined DER current distortion limits would need to be adjusted for the test.

A very stiff grid may allow significant low-order current harmonic levels for a synchronous generator, and yet not allow significant voltage distortion to develop.

There are application concerns in relieving the DER of responsibility for current and sharing responsibility for voltage distortion in the grid.

G.4.1 Challenges of field testing for compliance

There are several challenges involved with harmonic compliance testing in the field vs in the lab such as the following:

- a) Frequency response capabilities of typical utility grade PT and CT devices

- b) Influence of Area EPS background voltage distortion
- c) Influence of Area EPS harmonic impedances
- d) Resolution of monitoring equipment in regards to low values of current or voltage

Inverter based generation often includes pulse width modulated converters that have switching frequencies of several kHz. It is feasible to anticipate measurable 3 kHz (50th order) harmonics on the generated output. Documented cases show harmonics above the 50th present on inverter based DER outputs. However, many utility-grade voltage and current sensors will not accurately reproduce frequency content above 2 kHz. These practical constraints need to be considered for any field verification as well as the requirement for special equipment adhering to accuracy limits to monitor an inverter-based site. The practice to accept type and production testing results, and then address any field anomalies on a case-by-case basis may be preferred.

Because of the challenges, it is difficult to confirm adherence to the higher order distortion limits in the field. Therefore, it is important to consider not only individual limits but also the TRD limit. The expectation and intention is that if the individual harmonics and inter-harmonics limits that are tabulated in [Table 26](#) and [Table 27](#) are met, and the TRD value is met, then obviously the current distortion ought to be acceptable. In contrast, if a higher order individual limit measures outside the limit in the field, but the TRD is within limit, consideration should be given to whether the sensor involved is capable of accurately reproducing the frequency in question.

G.4.2 Background voltage distortion challenges

The presence of background voltage distortion is to be expected. As such, the DER current distortion performance can be affected by voltage distortion that exists before the installation of the DER. The current distortion requirements are intended to be written in a manner such that DER will not to be held responsible for current distortion that results from background voltage distortion.

Most DER appear as a harmonic voltage source behind an impedance that is primarily defined by the DER's physical series impedance (output filter in the case of inverters, subtransient inductance in the case of rotating generators) at higher harmonic orders. At lower harmonic orders, at frequencies within an order of magnitude of an inverter's current regulator control bandwidth, the control characteristics may significantly affect the effective impedance. The flow of harmonic current, into or out of the DER, is the phasor superposition of the flow due to the external harmonic voltage distortion with the DER's internal source shorted, and the flow due to the DER's internal harmonic voltage source with the grid's harmonic voltage source shorted (i.e., an undistorted grid). Given these basic characteristics, harmonic current flow may occur even when the DER is not providing a source at the particular harmonic frequency, or harmonic current flow may be substantially altered by grid distortion at frequencies where the DER does provide a source.

The characterization of voltage-source inverter and rotating generator DER as harmonic current sources is a generally inaccurate concept with today's technology. In the past, line-commutated converter technology was in common use and influenced industry's practices for harmonic distortion limitation (such as the original IEEE Std 519). Despite its limitations, and due to the lack of a suitable alternative, a current limitation approach is retained in this standard to maintain consistency within the industry.

DER that meet current distortion limits when connected to an undistorted external system, such as during type testing, may exceed current distortion limits when measured in a field environment having voltage distortion. In those situations, the Area EPS operator will need to determine the appropriate resolution. Many times, such current distortion flows in the presence of background voltage distortion are only slightly beyond limits and therefore, immaterial to the cumulative voltage distortion of the Area EPS. Such cases are not likely to warrant the additional costs associated with study designed for differentiating the distortion caused by the Area EPS. However, it is possible for the DER to be in resonance with a system harmonic impedance, in which case the measured current distortion would be significantly beyond the acceptable limit and in need of mitigation.

G.5 Limitation of overvoltage

Overvoltages may occur when DER is islanded with a ground fault present on the islanded system. The potential for overvoltage depends on the characteristics of the DER, presence of any external ground sources, and the characteristics of the load remaining connected to the island. Evaluation of such overvoltages in the case of rotating generator DER is well defined by conventional analysis practices. For current-regulated sources, such as inverters, conventional fault analysis practices are inaccurate. The latter situation is described in detail in IEEE Std C62.92.6, with recommendations for alternate analysis procedures.

G.6 Related standards

The following standards are related to this annex and provided here for convenience:

IEC/TR 61000-3-7, Electromagnetic compatibility (EMC)—Limits—Assessment of emission limits for the connection of fluctuating installations to MV, HV and EHV power systems.

IEC 61000-4-30:2015, Electromagnetic compatibility (EMC): Testing and measurement techniques—Power quality measurement methods.

IEEE Std 1453-2015, IEEE Recommended Practice—Adoption of IEC 61000-4-15:2010, Electromagnetic compatibility (EMC)—Testing and measurement techniques—Flickermeter—Functional and design specifications.

IEEE Std 1453.1-2012, IEEE Guide—Adoption of IEC 61000-3-7:2008, Electromagnetic compatibility (EMC)—Limits—Assessment of Emission Limit for the connection of fluctuating installations to MV, HV and EHV power systems.

IEEE Std C62.92.6-2017, IEEE Guide for the Application of Neutral Grounding in Electrical Utility Systems, Part VI—Systems Supplied by Current-Regulated Sources.

Annex H

(informative)

Figures illustrating general interconnection technical specifications and performance requirements of [Clause 4](#) to [Clause 6](#)

H.1 Informative figures related to [4.2](#) [Reference points of applicability (RPA)]

[Figure H.1](#) and [Figure H.2](#) relate to [4.2](#).

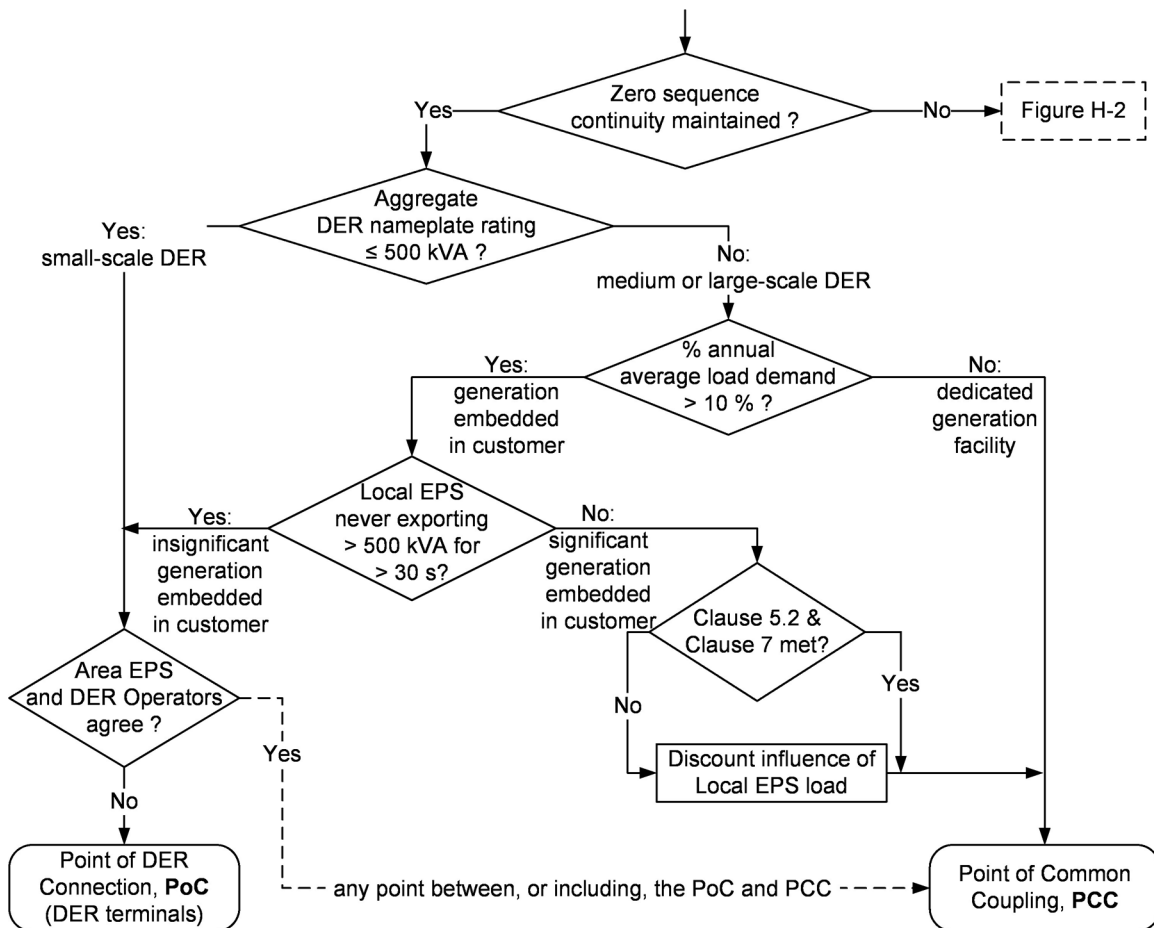

Figure H.1—Decision tree for reference point of applicability (RPA) for Local EPS where zero sequence continuity is maintained

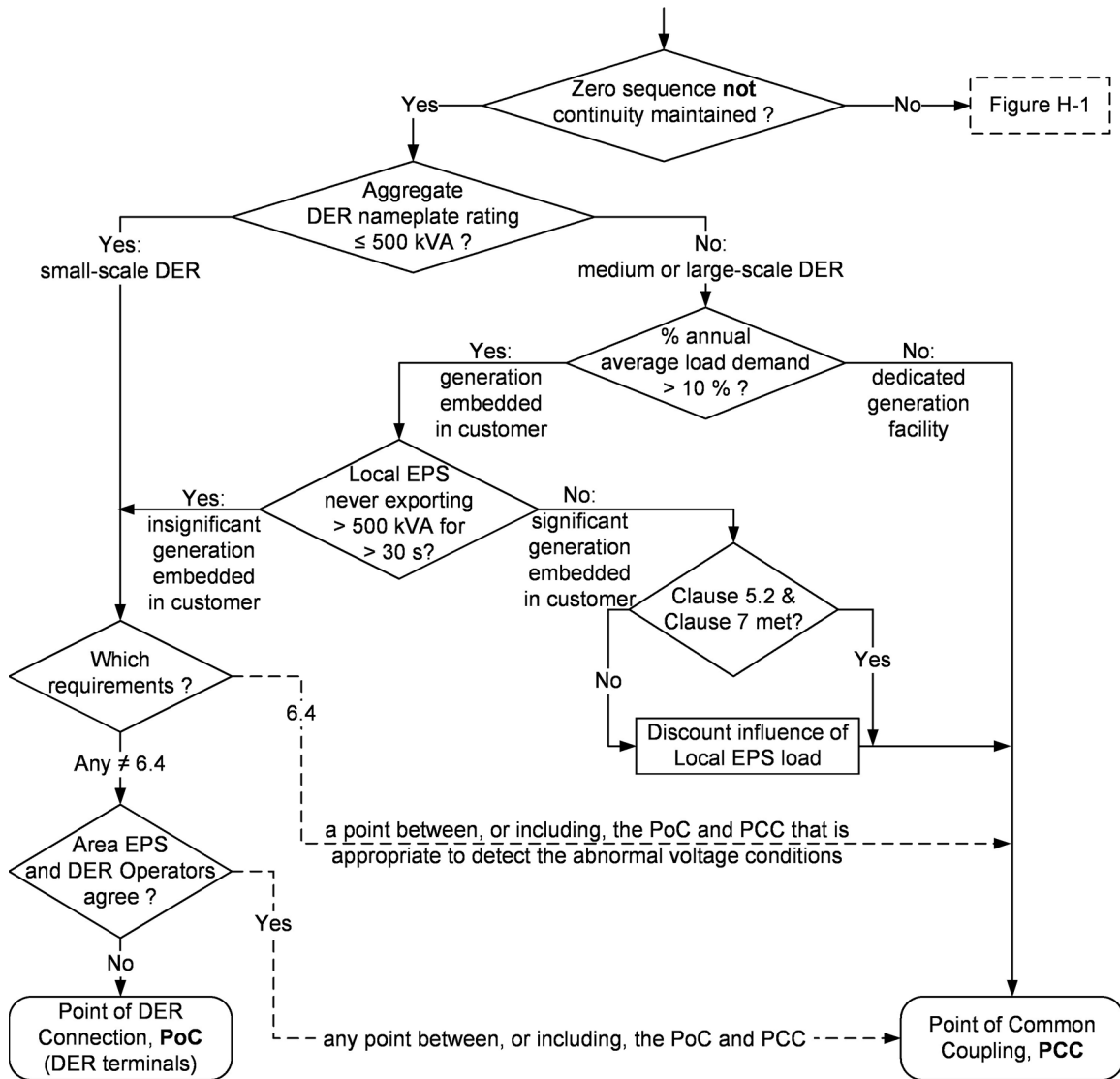

Figure H.2—Decision tree for reference point of applicability (RPA) for Local EPS where zero sequence continuity is not maintained

H.2 Informative figures related to Clause 5 (Reactive power capability and voltage/power control requirements)

Figure H.3 through Figure H.6 relate to Clause 5 of this standard.

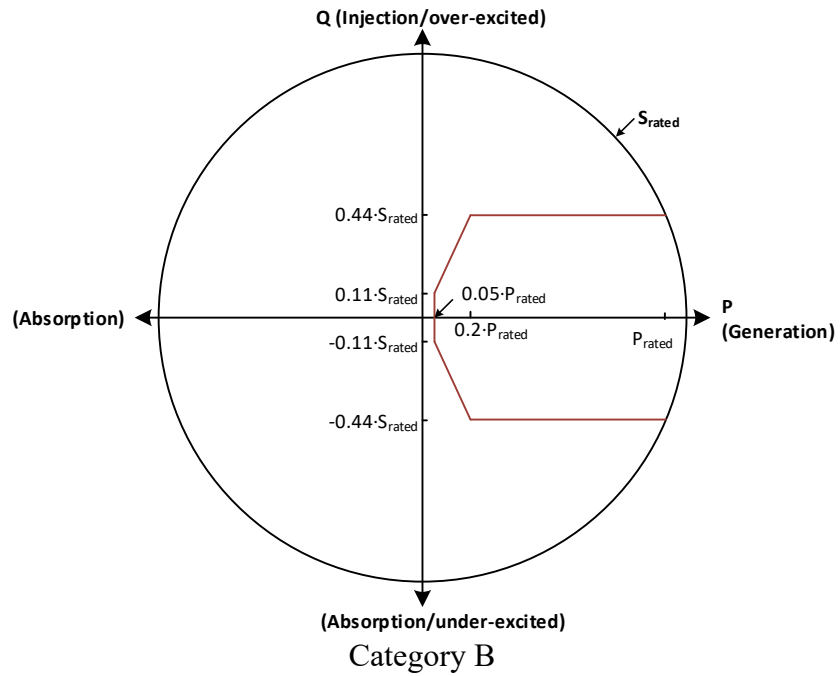
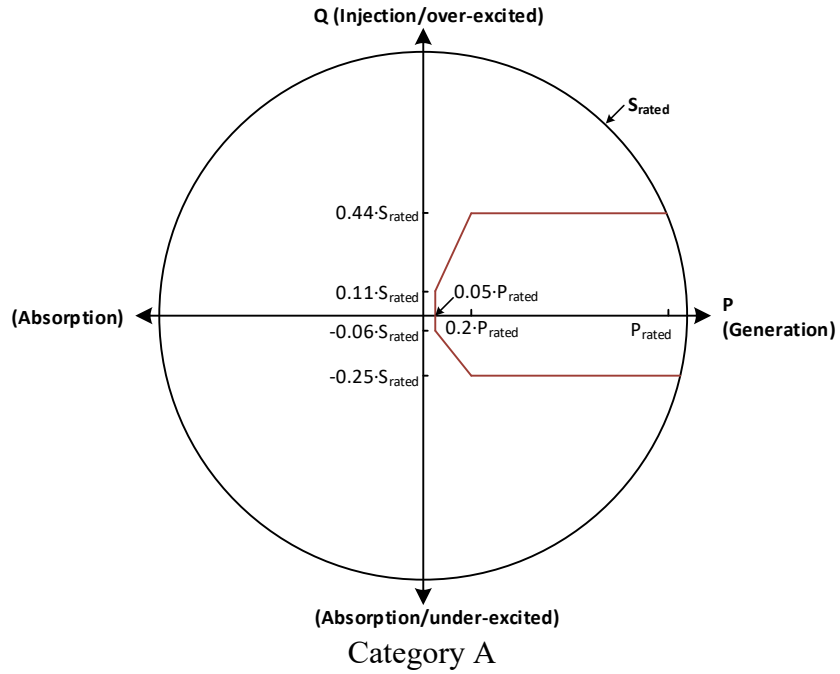

Figure H.3 —Minimum reactive power capability of Category A and B DER

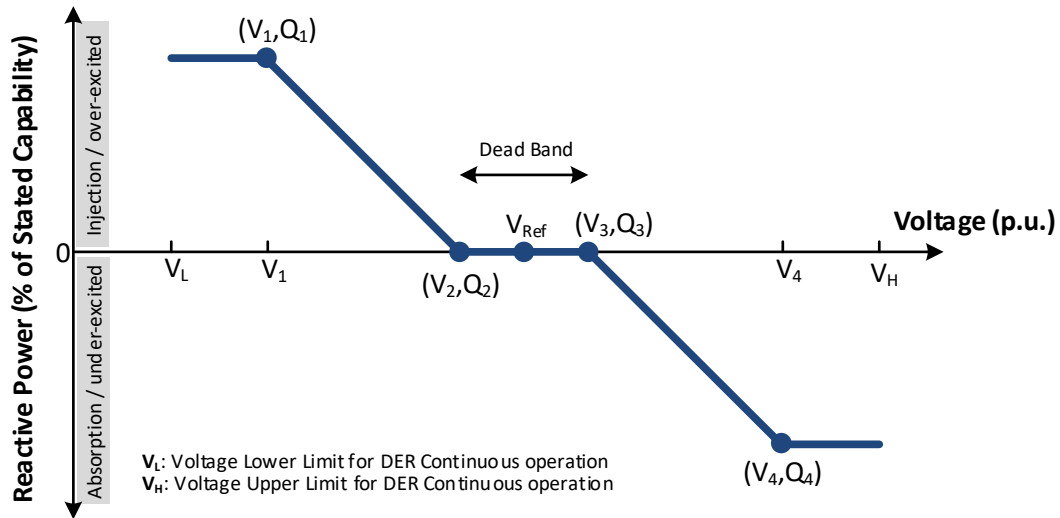

Figure H.4—Example voltage-reactive power characteristic

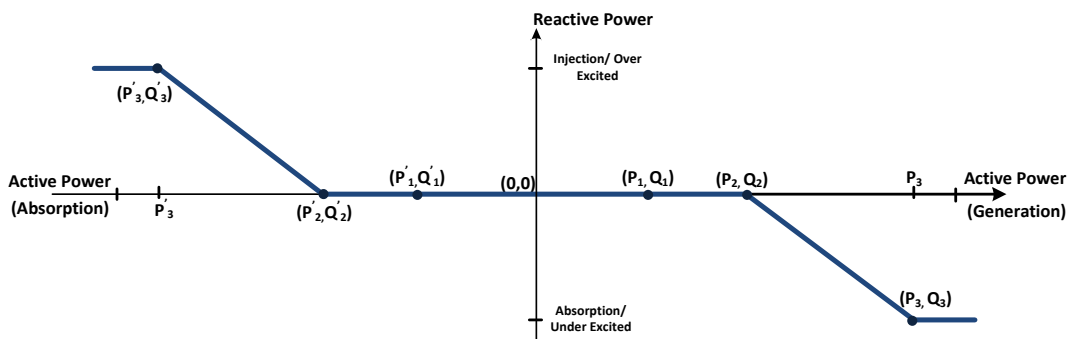

Figure H.5—Example active power-reactive power characteristic

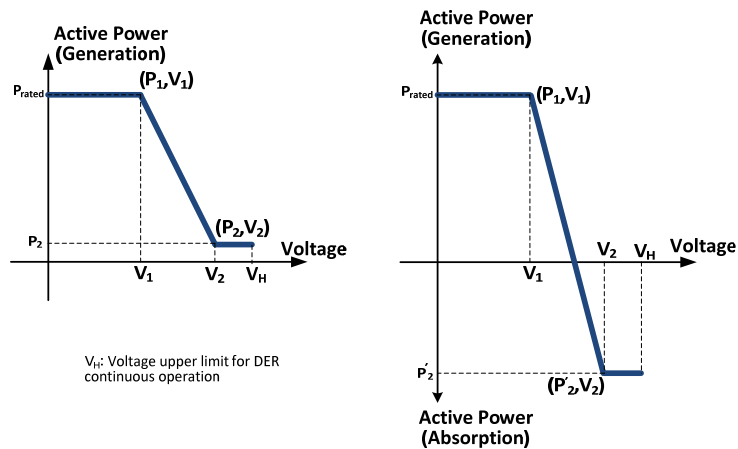

Figure H.6—Example voltage-active power characteristic

H.3 Informative figures related to Clause 6 (Response to Area EPS abnormal conditions)

Figure H.7 through Figure H.11 relate to Clause 6 of this standard.

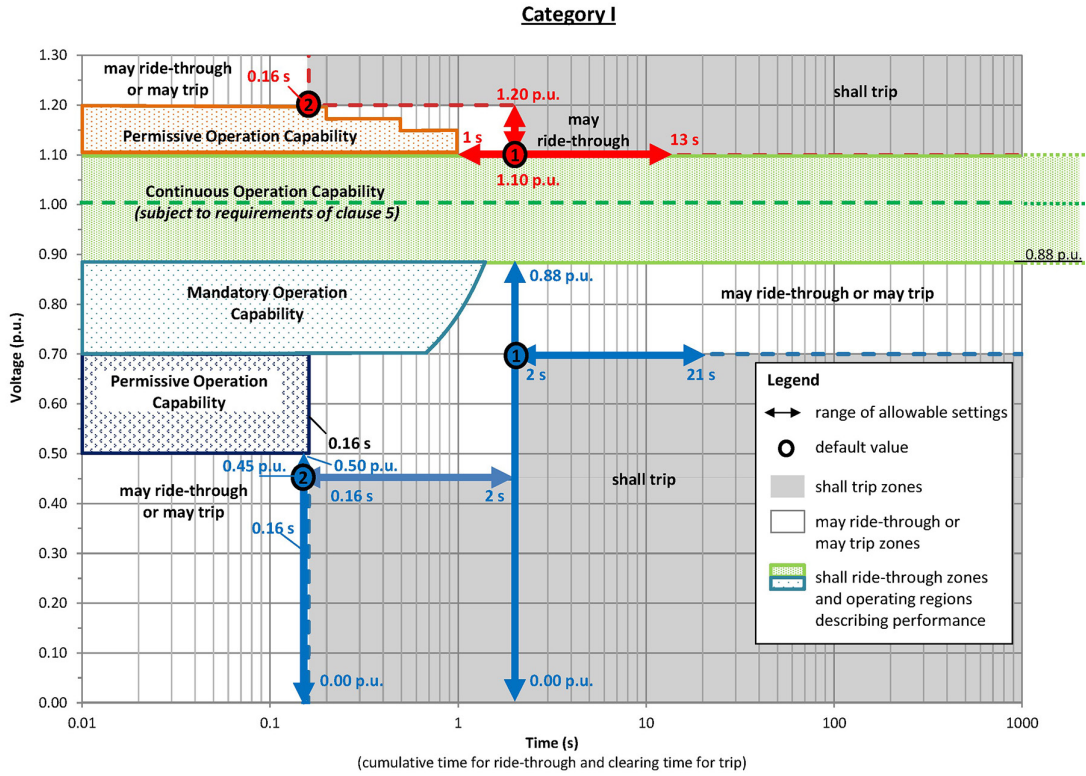

Figure H.7—DER response to abnormal voltages and voltage ride-through requirement for DER of abnormal operating performance Category I

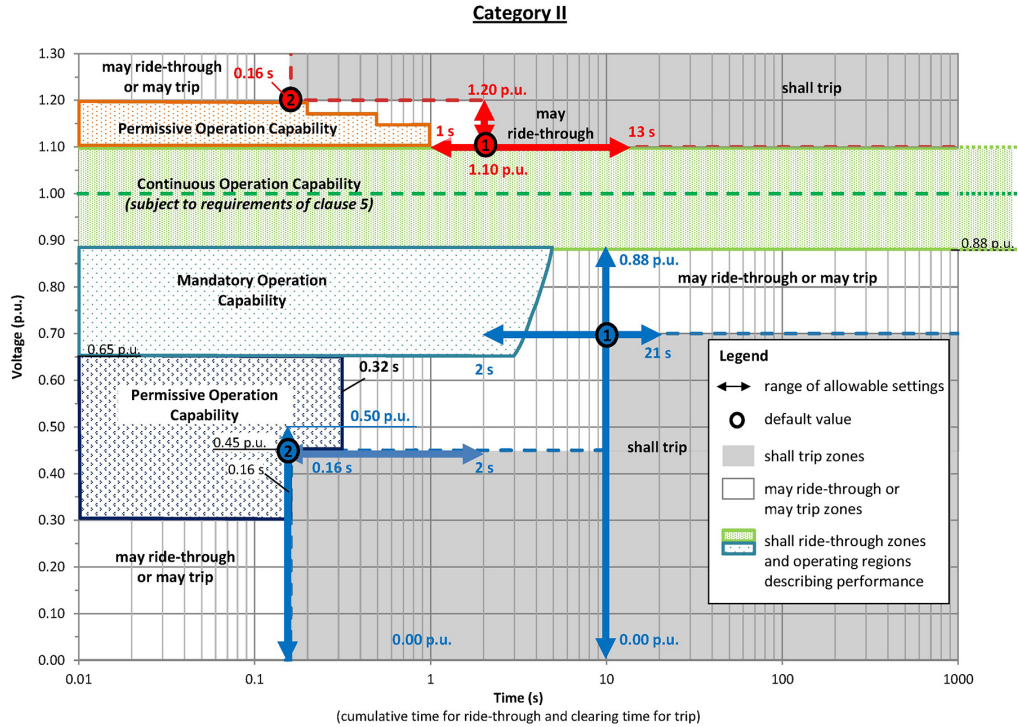

Figure H.8—DER response to abnormal voltages and voltage ride-through requirements for DER of abnormal operating performance Category II

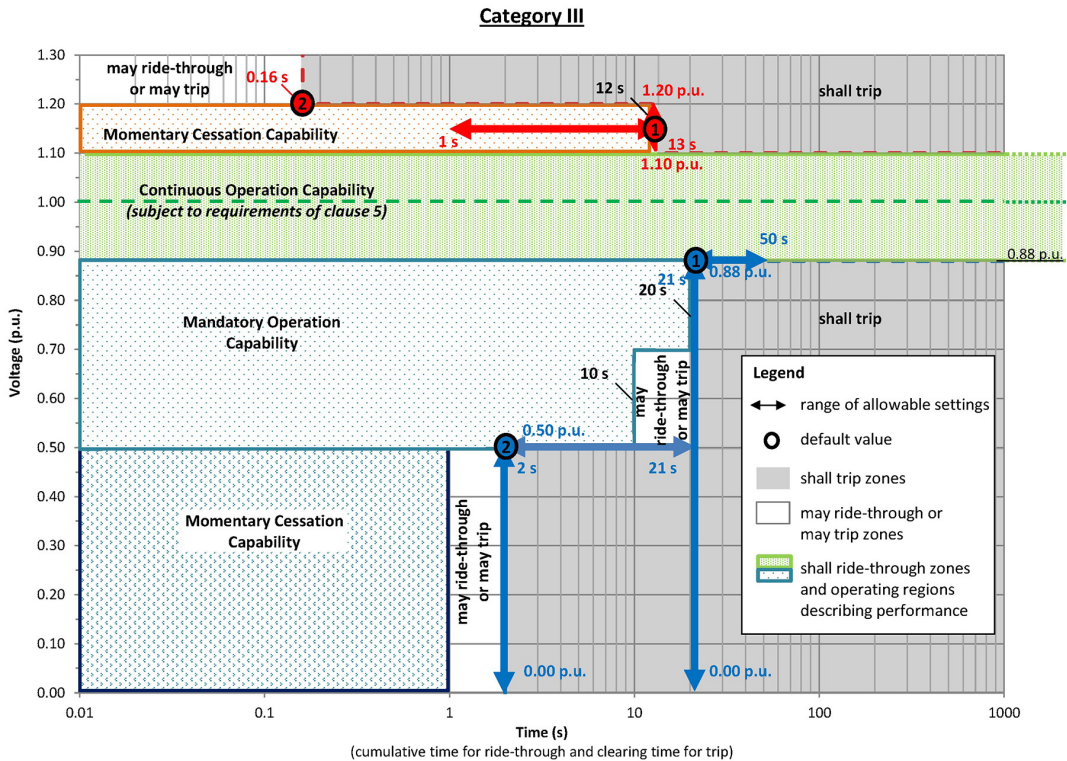

Figure H.9—DER response to abnormal voltages and voltage ride-through requirements for DER of abnormal operating performance Category III

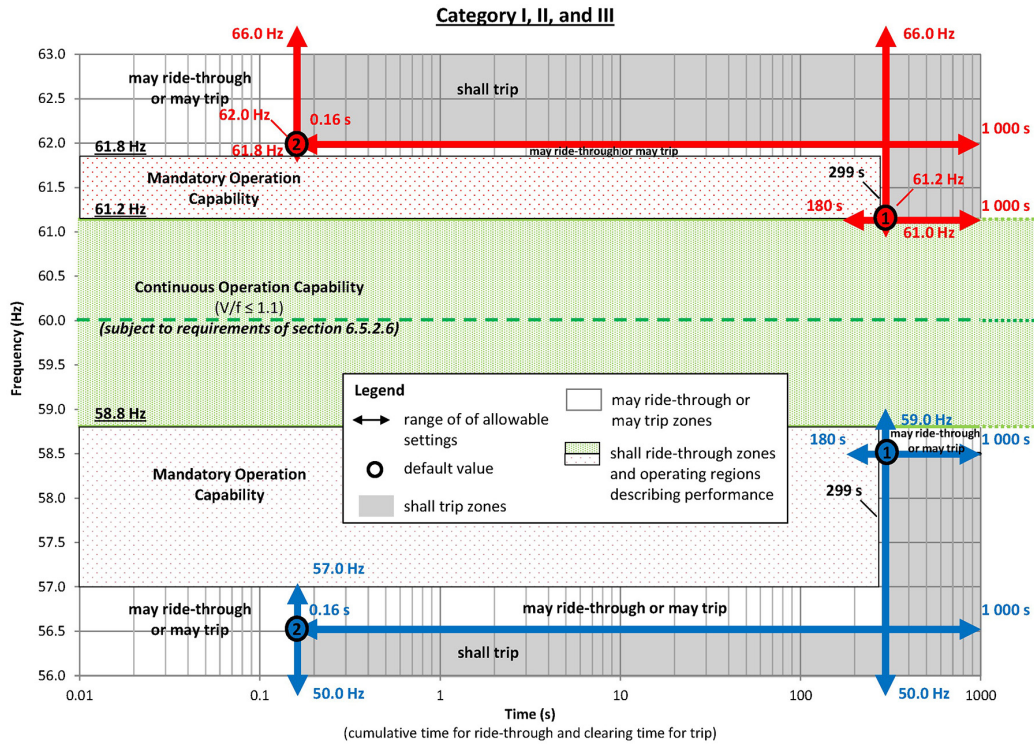

Figure H.10—DER default response to abnormal frequencies and frequency ride-through requirements for DER of abnormal operating performance Category I, Category II, and Category III

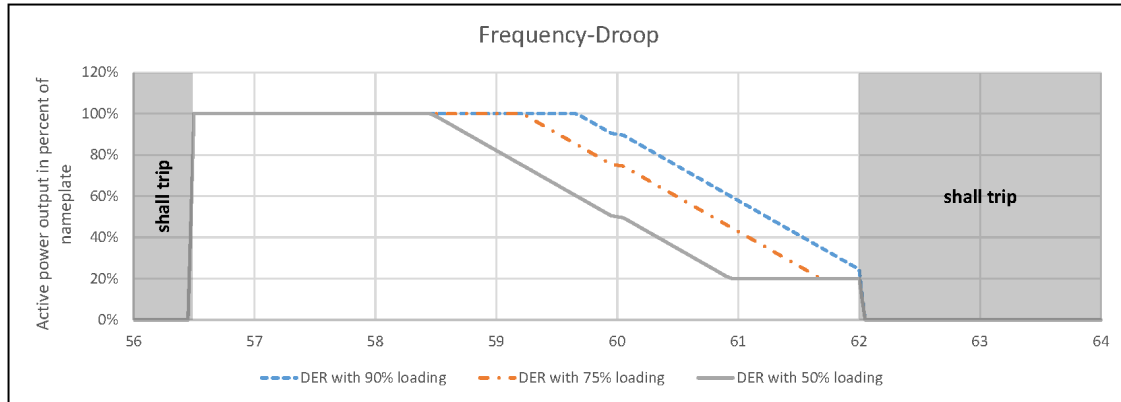

Figure H.11—Example of a three frequency-droop function curves with a 5% droop, 36 mHz deadband, and 20% minimum active power output for DER operating at different pre-disturbance levels of nameplate rating (50%, 75%, and 90%)

NOTE—A DER response during low-frequency conditions may be subject to *available active power* and the pre-disturbance dispatch level.

NATIONAL ANNEX J

(National Foreword)

(Normative)

J-1 This standard specifies the frequency as 60 Hz for standard testing condition. However, as per Indian conditions, the frequency shall be considered as 50 Hz.

J-2 (Page 15, Table 2) — Substitute the following for the existing:

Table 2 Applicable Voltages When PCC is Located at Low Voltage
(Clause 4.3)

SI No. (1)	Low-Voltage Winding Configuration of Area EPS Transformer (S) ^A (2)	Applicable Voltages (3)
i)	Grounded wye,	Phase-to-phase and phase-to-neutral, or Phase-to-phase and phase-to-ground
ii)	Ungrounded wye,	Phase-to-phase or phase-to-neutral
iii)	Delta ^b	Phase-to-phase
iv)	Single-phase	Line to neutral – for 230 V DER units
v)	Three-phase	Line to line – for 400 V DER units

J-3 (Page 16, Table 3) — Substitute the following for the existing:

Table 3 Minimum Measurement and Calculation Accuracy Requirements for Manufacturers^a
(Clause 4.4)

SI. No. (1)	Time Frame Parameter (2)	Steady-State Measurements			Transient Measurements		
		Minimum Measurement Accuracy (3)	Measurement Window (4)	Range (5)	Minimum Measurement Accuracy (6)	Measurement Window (7)	Range (8)
i)	Voltage, RMS	(± 1 % V_{nom})	10 cycles	0.5 p.u. to 1.2 p.u.	(± 2% V_{nom})	5 cycles	0.5 p.u. to 1.2 p.u.
ii)	Frequency ^b	10 mHz	50 cycles	40 Hz to 55 Hz	100 mHz	5 cycles	40 Hz to 55 Hz
iii)	Active Power	(± 5 % S_{rated})	10 cycles	0.2 p.u. <P <1.0 p.u.	Not required	N/A	N/A
iv)	Reactive Power	(± 5 % S_{rated})	10 cycles	0.2 p.u. <P <1.0 p.u.	Not required	N/A	N/A
v)	Time	1 % of measured duration	N/A	5 s to 600 s	2 cycles	N/A	100 ms < 5 s

^a A three-phase transformer or a bank of single-phase transformers may be used for three-phase systems.

^b Including delta with mid tap connection (grounded or ungrounded).

^a Measurement accuracy requirements specified in this table are applicable for voltage THD < 2.5 percent and individual voltage harmonics <1.5 percent.

^b Accuracy requirements for frequency are applicable only when the fundamental voltage is greater than 30 percent of the nominal voltage.

J-4 (Page 19, clause 4.10.2, Table 4) — Substitute the following for the existing:

Table 4 Enter Service Criteria for DER of Category I, Category II, and Category III
(Clause 4.10.2)

SI No. (1)	Enter Service Criteria (2)		Default Settings (3)	Ranges of Allowable Settings (4)
	Permit Service		Enabled	Enabled/Disabled
i)	Applicable voltage within range	Minimum value	≥ 0.9 p.u.	0.8 p.u. to 0.9 p.u.
ii)		Maximum value	≤ 1.1 p.u.	1.1 p.u. to 1.2 p.u.
iii)	Frequency within Range	Minimum value	≥ 49.5 Hz	49.0 Hz to 49.9 Hz
iv)		Maximum value	≤ 50.1 Hz	50.1 Hz to 51.0 Hz

J-5 [Page 19, clause 4.10.3(b), Table 4] — Substitute the following for the existing:

'DER shall be capable of delaying enter service by an intentional adjustable minimum delay when the Area EPS steady-state voltage and frequency are within the ranges specified in Table 4. The adjustable range of the minimum intentional delay shall be 0 s to 600 s with a default minimum delay of 60 s.'

J-6 (Page 20, clause 4.10.4, para 1) — Substitute the following for the existing:

'The DER shall operate in parallel with the area EPS without causing step changes in the RMS voltage at the PCC exceeding 5 percent of nominal when the PCC is at medium voltage, or exceeding 5 percent of nominal when the PCC is at low voltage.'

J-7 (Page 23, Table 7) — Substitute the following for the existing:

Table 7 Minimum Reactive Power Injection and Absorption Capability
(Clause 5.2)

SI No.	Injection Capability as % of Nameplate Apparent Power (kVA) Rating	Absorption Capability as % of Nameplate Apparent Power (kVa) Rating
i)	60	60

J-8 (Page 25, clause 5.3.3, Table 8) — Substitute the following for the existing:

Table 8 Voltage-Reactive Power Settings for Normal Operating Performance Category A and Category B DER
(Clause 5.3.3)

SI No. (1)	Voltage-Reactive Power Parameters (2)	Default Settings		Ranges of Allowable Settings	
		Category A (3)	Category B (4)	Minimum (5)	Maximum (6)
i)	V_{Ref}	V_N	V_N	$0.9 V_N$	$1.1 V_N$
ii)	V_2	V_N	$V_{Ref} - 0.02 V_N$	Category A: V_{Ref} Category B: $V_{Ref} - 0.03 V_N$	V_{Ref}^c

SI No.	Voltage-Reactive Power Parameters	Default Settings		Ranges of Allowable Settings	
		Category A	Category B	Minimum	Maximum
(1)	(2)	(3)	(4)	(5)	(6)
iii)	Q2	0	0	100 % of nameplate reactive power capability, absorption	100% of nameplate reactive power capability, injection
iv)	V3	V _N	V _{Ref} + 0.02 V _N	V _{Ref} ^c	Category A: V _{Ref} Category B: V _{Ref} + 0.03 V _N
v)	Q3	0	0	100% of nameplate reactive power capability, absorption	100 % of nameplate reactive power capability, injection
vi)	V1	0.9 V _N	V _{Ref} – 0.08 V _N	V _{Ref} – 0.18 V _N	V ₂ – 0.02 V _N ^c
vii)	Q ₁ ^a	25 % of nameplate apparent power rating, injection	60 % of nameplate apparent power rating, injection	0	100 % of nameplate reactive power capability, injection ^b
viii)	V4	1.1 V _N	V _{Ref} + 0.08 V _N	V3 + 0.02 V _N ^c	V _{Ref} + 0.18 V _N
ix)	Q4	25 % of nameplate apparent power rating, absorption	60 % of nameplate apparent power rating, absorption	100% of nameplate reactive power capability, absorption	0
x)	Open loop response time	10 s	5 s	1 s	90 s

J-9 (Page 26, clause 5.3.3, Table 9) — Substitute the following for the existing:

Table 9 Active Power-Reactive Power Settings for Normal Operating Performance: Category A and Category B DER
(Clause 5.3.3)

SI No.	Active Power-Reactive Power Parameters	Default Settings		Ranges of Allowable Settings	
		Category A	Category B	Minimum	Maximum
(1)	(2)	(3)	(4)	(5)	(6)
i)	P ₃	P _{rated}		P ₂ + 0.1 P _{rated}	P _{rated}
ii)	P ₂	0.5 P _{rated}		0.4 P _{rated}	0.8 P _{rated}
iii)	P ₁	The greater of 0.2 P _{rated} and P _{Min}		P _{Min}	P ₂ – 0.1 P _{rated}
iv)	P' ₁	The lesser of 0.2 P' _{rated} and P' _{Min}		P' ₂ – 0.1 P' _{rated}	P' _{Min}
v)	P' ₂	0.5 P' _{rated}		0.8 P' _{rated}	0.4 P' _{rated}
vi)	P' ₃	P' _{rated}		P' _{rated}	P' ₂ + 0.1 P' _{rated}
vii)	Q ₃	25 % of nameplate apparent	60 % of nameplate apparent	100 % of nameplate reactive power	100 % of nameplate reactive power

^aThe DER reactive power capability may be reduced at lower voltage.

^bIf needed DER may reduce active power output to meet this requirement.

^cImproper selection of these values may cause system instability.

SI No. (1)	Active Power- Reactive Power Parameters (2)	Default Settings		Ranges of Allowable Settings	
		Category A (3)	Category B (4)	Minimum (5)	Maximum (6)
		power rating, absorption	power rating, absorption	absorption capability	injection capability
viii)	Q ₂	0			
ix)	Q ₁	0			
x)	Q' ₁	0			
xi)	Q' ₂	0			
xii)	Q' ₃	60 % of nameplate apparent power rating, injection			
NOTE — Prated is the nameplate active power rating of the DER P'rated is the maximum active power that the DER can absorb P _{Min} is the minimum active power output of the DER P' _{Min} is the minimum, in amplitude, active power that the DER can absorb P' parameters are negative in value					

J-10 (Page 31, Table 11, Table 12, Table 13): Substitute the following for the existing:

Table 11, Table 12 and Table 13 DER Response (Shall Trip) to Abnormal Voltages for DER of Abnormal Operating Performance

SI No. (1)	Shall Trip Function (2)	Ranges of Allowable Settings	
		Voltage (P.U. of Nominal Voltage) (3)	Clearing Time (S) (4)
i)	Overtoltage	V > 1.1	2 s
ii)	Undervoltage	V < 0.8	2 s

J-11 (Page 41, Table 18) — Substitute the following for the existing:

Table 18 DER Response (Shall Trip) to Abnormal Frequencies for DER of Abnormal Operating Performance Category I, Category II, and Category III (see Figure H.10)
(Clause 6.5.1)

SI No. (1)	Shall Function (2)	Default Settings		Ranges of Allowable Settings	
		Frequency (Hz) (3)	Clearing time (s) (4)	Frequency (Hz) (5)	Clearing time (s) (6)
i)	OF	52.0	0.2	50.05 - 52.0	0.16 - 1 000
ii)	UF	47.5	0.2	47.5 - 48.8	0.16 - 1 000

J-12 (Page 55, clause 6.5.2) — Substitute the following for the existing:

'The DER shall continue normal operation within the frequency range of 47.5 Hz to 52 Hz. For over frequency (OF) events in the 50.05 Hz to 52.0 Hz, the DER shall continue operating and shall adjust the generated power to additional requirements of the central electricity authority (CEA). In the absence of central electricity authority requirements, the DER operator shall operate according to the requirements of the connected area EPS, distribution license.'

Bureau of Indian Standards

BIS is a statutory institution established under the *Bureau of Indian Standards Act, 2016* to promote harmonious development of the activities of standardization, marking and quality certification of goods and attending to connected matters in the country.

Copyright

Subject to BIS copyright interest in the country specific changes, copyright in this standard is held by IEEE. No part of these publications may be reproduced in any form without the prior written permission of the copyright owner. This does not preclude the free use, in course of implementing the standard, of necessary details, such as symbols and sizes, type or grade designations. Inquiries relating to copyright be addressed to the Director (Publications), BIS.

Review of Indian Standards

Amendments are issued to standards as the need arises on the basis of comments. Standards are also reviewed periodically; a standard along with amendments is reaffirmed when such review indicates that no changes are needed; if the review indicates that changes are needed, it is taken up for revision. Users of Indian Standards should ascertain that they are in possession of the latest amendments or edition by referring to the website- www.bis.gov.in or www.standardsbis.in.

This Indian Standard has been developed from Doc No.: ETD 46 (25260).

Amendments Issued Since Publication

Amend No.	Date of Issue	Text Affected

BUREAU OF INDIAN STANDARDS

Headquarters:

Manak Bhavan, 9 Bahadur Shah Zafar Marg, New Delhi 110002

Telephones: 2323 0131, 2323 3375, 2323 9402

Website: www.bis.gov.in

Regional Offices:

Central : 601/A, Konnectus Tower -1, 6th Floor,
DMRC Building, Bhavbhuti Marg, New
Delhi 110002

Telephones

{ 2323 7617

Eastern : 8th Floor, Plot No 7/7 & 7/8, CP Block, Sector V,
Salt Lake, Kolkata, West Bengal 700091

{ 2367 0012
2320 9474

Northern : Plot No. 4-A, Sector 27-B, Madhya Marg,
Chandigarh 160019

{ 265 9930

Southern : C.I.T. Campus, IV Cross Road, Taramani, Chennai 600113

{ 2254 1442
2254 1216

Western : 5th Floor/MTNL CETTM, Technology Street, Hiranandani Gardens, Powai
Mumbai 400076

{ 2570 0030
2570 2715

Branches : AHMEDABAD, BENGALURU, BHOPAL, BHUBANESHWAR, CHANDIGARH, CHENNAI, COIMBATORE, DEHRADUN, DELHI, FARIDABAD, GHAZIABAD, GUWAHATI, HARYANA (CHANDIGARH), HUBLI, HYDERABAD, JAIPUR, JAMMU, JAMSHEDPUR, KOCHI, KOLKATA, LUCKNOW, MADURAI, MUMBAI, NAGPUR, NOIDA, PARWANOO, PATNA, PUNE, RAIPUR, RAJKOT, SURAT, VIJAYAWADA.