

पूर्ण भरे बहाव वाली वृत्ताकार अनुप्रस्थ काट
की वाहिकाओं में विभेदक दबाव उपकरणों
के माध्यम से द्रव प्रवाह मापन
भाग 1 सामान्य सिद्धांत एवं अपेक्षाएँ
(दूसरा पुनरीक्षण)

**Measurement of Fluid Flow by Means
of Pressure Differential Devices
Inserted in Circular Cross Section
Conduits Running Full**
**Part 1 General Principles and
Requirements**
(*Second Revision*)

ICS 17.120.10

© BIS 2024
© ISO 2022



भारतीय मानक ब्यूरो
BUREAU OF INDIAN STANDARDS
मानक भवन, 9 बहादुर शाह ज़फर मार्ग, नई दिल्ली - 110002
MANAK BHAVAN, 9 BAHADUR SHAH ZAFAR MARG
NEW DELHI - 110002
www.bis.gov.in www.standardsbis.in

NATIONAL FOREWORD

This standard (Part 1) (Second Revision) which is identical to ISO 5167-1 : 2022 'Measurement of fluid flow by means of pressure differential devices inserted in circular cross-section conduits running full — Part 1: General principles and requirements (Second Revision)' issued by the International Organization for Standardization (ISO). This standard was adopted by the Bureau of Indian Standards on the recommendation of the Hydrometry Sectional Committee and was approved by the Water Resources Division Council.

This standard was first published in 1999, based on ISO 5167-1 : 1991. The first revision was brought out in 2018 to align it with the then latest version of ISO 5167-1 : 2003. This second revision has been undertaken to align it with the latest version of ISO 5167-1 : 2022.

This standard is published in five parts. Other parts in this series are:

- Part 2 Orifice plates
- Part 3 Nozzle and venturi nozzles
- Part 4 Venturi tubes
- Part 5 Cone meters

The text of ISO standard has been approved as suitable for publication as an Indian Standard without deviations. Certain conventions are, however, not identical to those used in Indian Standards. Attention is particularly drawn to the following:

- a) Wherever the words 'International Standard' appear referring to this standard, they should be read as 'Indian Standard; and
- b) Comma (,) has been used as a decimal marker, while in Indian Standards, the current practice is to use a point (.) as the decimal marker.

In this adopted standard, reference to certain International Standards appears for which Indian Standards also exist. The corresponding Indian Standards, which are to be substituted in their respective places, are listed below along with their degree of equivalence for the editions indicated:

<i>International Standard</i>	<i>Corresponding Indian Standard</i>	<i>Degree of Equivalence</i>
ISO 5167-2 Measurement of fluid flow by means of pressure differential devices inserted in circular cross-section conduits running full — Part 2: Orifice plates	IS 14615 (Part 2) : 2018/ISO 5167-2 : 2003 Measurement of fluid flow by means of pressure differential devices inserted in circular cross section conduits running full: Part 2 Orifice plates	Identical
ISO 5167-3 Measurement of fluid flow by means of pressure differential devices inserted in circular cross-section conduits running full — Part 3: Nozzles and venturi nozzles	IS 14615 (Part 3) : 2024/ISO 5167-3 : 2022 Measurement of fluid flow by means of pressure differential devices inserted in circular cross section conduits running full: Part 3 Nozzles and venturi nozzles	Identical
ISO 5167-4 Measurement of fluid flow by means of pressure differential devices inserted in circular cross-section conduits running full — Part 4: Venturi tubes	IS 14615 (Part 4) : 2018/ISO 5167-4 : 2003 Measurement of fluid flow by means of pressure differential devices inserted in circular cross section conduits running full: Part 4 Venturi tubes	Identical

(Continued on third cover)

Contents

Page

Introduction	vi
1 Scope	1
2 Normative references	1
3 Terms and definitions	1
3.1 Pressure measurement.....	2
3.2 Primary devices.....	2
3.3 Flow.....	3
4 Symbols and subscripts	6
4.1 Symbols.....	6
5 Principle of the method of measurement and computation	7
5.1 Principle of the method of measurement.....	7
5.2 Method of determination of the required diameter ratio for the selected standard primary device.....	8
5.3 Computation of flow rate.....	8
5.4 Determination of density, pressure and temperature.....	8
5.4.1 General.....	8
5.4.2 Density.....	9
5.4.3 Static pressure.....	9
5.4.4 Temperature.....	9
5.5 Differential pressure flow measurement system.....	10
5.5.1 General.....	10
5.5.2 Primary device.....	11
5.5.3 Impulse lines and transmitters.....	12
5.5.4 Impulse line isolation valves and valve manifolds.....	12
5.5.5 Flow computer.....	12
5.6 Differential pressure flow measurement system design considerations.....	12
5.6.1 Flow rate turndown and stacked transmitters.....	12
5.6.2 Meter calibration.....	12
5.6.3 Permanent pressure loss.....	13
5.6.4 Diagnostics and meter verification.....	14
5.6.5 Overall uncertainty of differential pressure metering system.....	14
6 General requirements for the measurements	14
6.1 Primary device.....	14
6.2 Nature of the fluid.....	15
6.3 Flow conditions.....	15
7 Installation requirements	15
7.1 General.....	15
7.2 Minimum upstream and downstream straight lengths.....	17
7.3 General requirement for flow conditions at the primary device.....	17
7.3.1 Requirement.....	17
7.3.2 Swirl-free conditions.....	17
7.3.3 Good velocity profile conditions.....	17
7.4 Flow conditioners.....	17
7.4.1 Compliance testing.....	17
7.4.2 Specific test.....	20
8 Uncertainties on the measurement of flow rate	20
8.1 General.....	20
8.2 Definition of uncertainty.....	20
8.3 Practical computation of the uncertainty.....	21
8.3.1 Component uncertainties.....	21

8.3.2 Practical working formula.....	21
Annex A (informative) Iterative computations.....	24
Annex B (informative) Examples of values of the pipe wall uniform equivalent roughness, k_a.....	26
Annex C (informative) Flow conditioners and flow straighteners.....	27
Annex D (informative) Differential pressure transmitters, flow range and turndown.....	29
Annex E (informative) Example of uncertainty calculation for a differential pressure device.....	36
Annex F (informative) Permanent pressure loss example.....	40
Bibliography.....	42

Introduction

ISO 5167, consisting of six parts, covers the geometry and method of use (installation and operating conditions) of orifice plates, nozzles, Venturi tubes, cone meters and wedge meters when they are inserted in a conduit running full to determine the flow rate of the fluid flowing in the conduit. It also gives necessary information for calculating the flow rate and its associated uncertainty.

ISO 5167 (all parts) is applicable only to pressure differential devices in which the flow remains subsonic throughout the measuring section and where the fluid can be considered as single-phase, but is not applicable to the measurement of pulsating flow. Furthermore, each of these devices can only be used uncalibrated within specified limits of pipe size and Reynolds number, or alternatively they can be used across their calibrated range.

ISO 5167 (all parts) deals with devices for which direct calibration experiments have been made, sufficient in number, spread and quality to enable coherent systems of application to be based on their results and coefficients to be given with certain predictable limits of uncertainty. ISO 5167 also provides methodology for bespoke calibration of differential pressure meters.

The devices introduced into the pipe are called primary devices. The term primary device also includes the pressure tappings. All other instruments or devices required to facilitate the instrument readings are known as secondary devices, and the flow computer that receives these readings and performs the algorithms is known as a tertiary device. ISO 5167 covers primary devices; secondary devices (see ISO 2186) and tertiary devices will be mentioned only occasionally.

Aspects of safety are not dealt with in ISO 5167-1 to ISO 5167-6. It is the responsibility of the user to ensure that the system meets applicable safety regulations.

Additional documents that may provide assistance include:

- ISO/TR 3313;
- ISO/TR 9464;
- ISO/TR 12767;
- ISO/TR 15377.

Indian Standard

MEASUREMENT OF FLUID FLOW BY MEANS OF PRESSURE
DIFFERENTIAL DEVICES INSERTED IN CIRCULAR CROSS-
SECTION CONDUITS RUNNING FULL

PART 1 GENERAL PRINCIPLES AND REQUIREMENTS

(*Second Revision*)

1 Scope

This document defines terms and symbols and establishes the general principles for methods of measurement and computation of the flow rate of fluid flowing in a conduit by means of pressure differential devices (orifice plates, nozzles, Venturi tubes, cone meters, and wedge meters) when they are inserted into a circular cross-section conduit running full. This document also specifies the general requirements for methods of measurement, installation and determination of the uncertainty of the measurement of flow rate.

ISO 5167 (all parts) is applicable only to flow that remains subsonic throughout the measuring section and where the fluid can be considered as single-phase. It is not applicable to the measurement of pulsating flow.

2 Normative references

The following documents are referred to in the text in such a way that some or all of their content constitutes requirements of this document. For dated references, only the edition cited applies. For undated references, the latest edition of the referenced document (including any amendments) applies.

ISO 4006, *Measurement of fluid flow in closed conduits — Vocabulary and symbols*

ISO 5167 (all parts), *Measurement of fluid flow by means of pressure differential devices inserted in circular cross-section conduits running full*

ISO 5168, *Measurement of fluid flow — Procedures for the evaluation of uncertainties*

ISO/IEC Guide 98-3, *Uncertainty of measurement — Part 3: Guide to the expression of uncertainty in measurement (GUM:1995)*

3 Terms and definitions

For the purposes of this document, the terms, definitions and symbols given in ISO 4006 and the following apply.

ISO and IEC maintain terminology databases for use in standardization at the following addresses:

- ISO Online browsing platform: available at <https://www.iso.org/obp>
- IEC Electropedia: available at <https://www.electropedia.org/>

3.1 Pressure measurement

3.1.1

wall pressure tapping

annular slot or circular hole drilled in the wall of a conduit in such a way that the edge of the hole is flush with the internal surface of the conduit

Note 1 to entry: The pressure tapping is usually a circular hole but in certain cases may be an annular slot.

3.1.2

static pressure

p

pressure which can be measured by connecting a pressure-measuring device to a *wall pressure tapping* ([3.1.1](#))

Note 1 to entry: Only the value of the absolute static pressure is considered in ISO 5167 (all parts).

3.1.3

differential pressure

DP

Δp

difference between the (static) pressures measured at the wall pressure tapplings, one of which is on the upstream side and the other of which is on the downstream side of a primary device [or in the throat for a throat-tapped nozzle, a *Venturi nozzle* ([3.2.4](#)) or a *Venturi tube* ([3.2.5](#))], inserted in a straight pipe through which flow occurs, when any difference in height between the upstream and downstream tapplings has been taken into account

Note 1 to entry: In ISO 5167 (all parts) the term “differential pressure” is used only if the pressure tapplings are in the positions specified for each standard primary device.

3.1.4

pressure ratio

τ

ratio of the absolute (static) pressure at the downstream pressure tapping to the absolute (static) pressure at the upstream pressure tapping

3.1.5

vena contracta

location in a fluid stream where the diameter of the stream is smallest

3.2 Primary devices

3.2.1

orifice

throat opening of minimum cross-sectional area of a primary device

3.2.2

orifice plate

thin plate in which a circular opening has been machined

Note 1 to entry: Standard orifice plates are described as “thin plate” and “with sharp square edge”, because the thickness of the plate is small compared with the diameter of the measuring section and because the upstream edge of the *orifice* ([3.2.1](#)) is sharp and square.

3.2.3

nozzle

device which consists of a convergent inlet connected to a cylindrical section generally called the “throat”

3.2.4

Venturi nozzle

device which consists of a convergent inlet which is a standardized ISA 1932 nozzle connected to a cylindrical part called the “throat”, which is itself connected to an expanding section called the “divergent” which is conical

3.2.5

Venturi tube

device which consists of a convergent inlet which is conical connected to a cylindrical part called the “throat”, which is itself connected to an expanding section called the “divergent” which is conical

3.2.6

cone meter

device which consists of a cone-shaped restriction held in the centre of the pipe with the nose of the cone upstream

3.2.7

wedge meter

device which consists of a wedge-shaped restriction

3.2.8

diameter ratio

β

<of a primary device used in a given pipe> square root of the ratio of the area of the throat of the primary device to the internal area of the measuring pipe upstream of the primary device

Note 1 to entry: In ISO 5167-2 and ISO 5167-3 the diameter ratio is the ratio of the diameter of the throat of the primary device to the internal diameter of the measuring pipe upstream of the primary device.

Note 2 to entry: In ISO 5167-4, where the primary device has a cylindrical section upstream, having the same diameter as that of the pipe, the diameter ratio is the ratio of the throat diameter to the diameter of this cylindrical section at the plane of the upstream pressure tapings.

3.2.9

carrier ring

device which is used to hold the primary element in the centre of the pipe and may incorporate the pressure tapings

3.3 Flow

3.3.1

flow rate

rate of flow

q

mass or volume of fluid passing through the primary device per unit time

3.3.1.1

mass flow rate

rate of mass flow

q_m

mass of fluid passing through the primary device per unit time

3.3.1.2

volume flow rate

rate of volume flow

q_v

volume of fluid passing through the primary device per unit time

Note 1 to entry: In the case of volume flow rate, it is necessary to state the pressure and temperature at which the volume is referenced.

3.3.2

Reynolds number

Re

dimensionless parameter expressing the ratio between the inertia and viscous forces

3.3.2.1

pipe Reynolds number

Re_D

dimensionless parameter expressing the ratio between the inertia and viscous forces in the upstream pipe

$$Re_D = \frac{V_1 D}{\nu_1} = \frac{4q_m}{\pi \mu_1 D}$$

3.3.2.2

throat Reynolds number

Re_d

dimensionless parameter expressing the ratio between the inertia and viscous forces in the orifice or throat of the primary device

$$Re_d = \frac{Re_D}{\beta}$$

Note 1 to entry: When an orifice plate is used the throat Reynolds number is sometimes called the orifice Reynolds number.

3.3.3

isentropic exponent

κ

ratio of the relative variation in pressure to the corresponding relative variation in density under elementary reversible adiabatic (isentropic) transformation conditions

Note 1 to entry: The isentropic exponent κ appears in the different formulae for the expansibility [expansion] factor ϵ and varies with the nature of the gas and with its temperature and pressure.

Note 2 to entry: There are many gases and vapours for which no values for κ have been published so far, particularly over a wide range of pressure and temperature. In such a case, for the purposes of ISO 5167 (all parts), the ratio of the specific heat capacity at constant pressure to the specific heat capacity at constant volume of ideal gases can be used in place of the isentropic exponent.

3.3.4

Joule Thomson coefficient

isenthalpic temperature-pressure coefficient

μ_{JT}

rate of change of temperature with respect to pressure at constant enthalpy:

$$\mu_{JT} = \left. \frac{\partial T}{\partial p} \right|_H$$

Note 1 to entry: The Joule Thomson coefficient varies with the nature of the gas and with its temperature and pressure and can be calculated.

Note 2 to entry: An approximation for the Joule Thomson coefficient for some natural gases is given in ISO/TR 9464:2008, 5.1.5.4.4.

3.3.5 discharge coefficient

C

coefficient, defined for an incompressible fluid flow, which relates the actual flow rate to the theoretical flow rate through a device, and is given by the formula for incompressible fluids

$$C = \frac{q_m \sqrt{1 - \beta^4}}{A_t \sqrt{2 \Delta p \rho_1}}$$

Note 1 to entry: Calibration of standard primary devices by means of incompressible fluids (liquids) shows that the discharge coefficient is dependent only on the Reynolds number for a given primary device in a given installation.

The numerical value of C for any individual differential pressure meter is the same for different installations whenever such installations are geometrically similar and the flows are characterised by identical Reynolds numbers.

The formulae for the numerical values of C given in ISO 5167 (all parts) are based on data determined experimentally.

The uncertainty in the value of C can be reduced by flow calibration in a suitable laboratory.

Note 2 to entry: The quantity $1 / \sqrt{1 - \beta^4}$ is called the “velocity of approach factor”, and $C \frac{1}{\sqrt{1 - \beta^4}}$ is called the “flow coefficient”.

3.3.6 expansibility [expansion] factor

ε

coefficient used to take into account the compressibility of the fluid

$$\varepsilon = \frac{q_m \sqrt{1 - \beta^4}}{A_t C \sqrt{2 \Delta p \rho_1}}$$

Note 1 to entry: Calibration of a given primary device by means of a compressible fluid (gas) shows that the following ratio is dependent on the value of the Reynolds number as well as on the values of the pressure ratio and the isentropic exponent of the gas:

$$\frac{q_m \sqrt{1 - \beta^4}}{A_t \sqrt{2 \Delta p \rho_1}}$$

The method adopted for representing these variations consists of multiplying the discharge coefficient, C , of the primary device considered, as determined by direct calibration carried out with liquids for the same value of the Reynolds number, by the expansibility [expansion] factor, ε .

The expansibility factor, ε , is equal to unity when the fluid is considered incompressible (liquid) and is less than unity when the fluid is compressible (gaseous).

This method is possible because experiments show that ε is practically independent of the Reynolds number and, for a given diameter ratio of a given primary device, ε only depends on the pressure ratio and the isentropic exponent.

The numerical values of ε for orifice plates given in ISO 5167-2 and for cone meters given in ISO 5167-5 are based on data determined experimentally. For nozzles (see ISO 5167-3), Venturi tubes (see ISO 5167-4) and wedge meters (see ISO 5167-6) they are based on the thermodynamic general formula applied to isentropic expansion.

3.3.7 arithmetical mean deviation of the roughness profile

Ra

arithmetical mean deviation from the mean line of the profile being measured

Note 1 to entry: The mean line is such that the sum of the squares of the distances between the effective surface and the mean line is a minimum. In practice, *Ra* can be measured with standard equipment for machined surfaces but can only be estimated for rougher surfaces of pipes. See also ISO 21920-3.

Note 2 to entry: For pipes, the uniform equivalent roughness k_a may also be used. This value can be determined experimentally (see 7.1.5) or taken from tables (see Annex B).

4 Symbols and subscripts

4.1 Symbols

Table 1 — Symbols

Symbol	Quantity	Dimension ^a	SI unit
A_t	Area of throat	L^2	m^2
C	Discharge coefficient	dimensionless	—
$C_{m,p}$	Molar-heat capacity at constant pressure	$ML^2T^{-2}\Theta^{-1}mol^{-1}$	J/(mol·K)
d	Diameter of orifice (or throat) of primary device under working conditions	L	m
D	Upstream internal pipe diameter (or upstream diameter of a classical Venturi tube) under working conditions	L	m
H	Enthalpy	$ML^2T^{-2}mol^{-1}$	J/mol
k	Coverage factor	dimensionless	—
k_a	Uniform equivalent roughness	L	m
K	Pressure loss coefficient (the ratio of the pressure loss, $\Delta\varpi$, to the dynamic pressure, $\rho V^2/2$), also known as the minor loss coefficient	dimensionless	—
l	Pressure tapping spacing	L	m
L	Relative pressure tapping spacing: $L = l/D$	dimensionless	—
p	Absolute static pressure of the fluid	$ML^{-1}T^{-2}$	Pa
q_m	Mass flow rate	MT^{-1}	kg/s
q_V	Volume flow rate	L^3T^{-1}	m^3/s
R	Radius	L	m
R_u	Universal gas constant	$ML^2T^{-2}\Theta^{-1}mol^{-1}$	J/(mol·K)
Ra	Arithmetical mean deviation of the (roughness) profile	L	m
Re	Reynolds number	dimensionless	—
Re_d	Throat Reynolds number	dimensionless	—
Re_D	Pipe Reynolds number	dimensionless	—
t	Temperature of the fluid	Θ	°C
T	Absolute (thermodynamic) temperature of the fluid	Θ	K
u	Standard uncertainty	c	c

^a M = mass, L = length, T = time, Θ = temperature

^b γ is the ratio of the specific heat capacity at constant pressure to the specific heat capacity at constant volume. For ideal gases, the ratio of the specific heat capacities and the isentropic exponent have the same value (see 3.3.3). These values depend on the nature of the gas.

^c The dimensions and units are those of the corresponding quantity.

Table 1 (continued)

Symbol	Quantity	Dimension ^a	SI unit
u'	Relative standard uncertainty	dimensionless	—
U	Expanded uncertainty	^c	^c
U'	Relative expanded uncertainty	dimensionless	—
V	Mean axial velocity of the fluid in the pipe	LT^{-1}	m/s
Z	Compressibility factor	dimensionless	—
β	Diameter ratio	dimensionless	—
γ	Ratio of specific heat capacities ^b	dimensionless	—
Δp	Differential pressure: $\Delta p = p_1 - p_2$	$ML^{-1}T^{-2}$	Pa
Δp_c	Pressure loss across a flow conditioner	$ML^{-1}T^{-2}$	Pa
$\Delta \varpi$	Pressure loss across a primary device	$ML^{-1}T^{-2}$	Pa
ε	Expansibility [expansion] factor	dimensionless	—
κ	Isentropic exponent ^b	dimensionless	—
λ	Friction factor	dimensionless	—
μ	Dynamic viscosity of the fluid	$ML^{-1}T^{-1}$	Pa·s
μ_{JT}	Joule Thomson coefficient	$M^{-1}LT^2\Theta$	K/Pa
ν	Kinematic viscosity of the fluid: $\nu = \mu/\rho$	L^2T^{-1}	m ² /s
ξ	Relative pressure loss (the ratio of the pressure loss to the differential pressure)	dimensionless	—
ρ	Density of the fluid	ML^{-3}	kg/m ³
τ	Pressure ratio: $\tau = p_2/p_1$	dimensionless	—
ϕ	Total angle of the divergent section	dimensionless	rad
^a M = mass, L = length, T = time, Θ = temperature ^b γ is the ratio of the specific heat capacity at constant pressure to the specific heat capacity at constant volume. For ideal gases, the ratio of the specific heat capacities and the isentropic exponent have the same value (see 3.3.3). These values depend on the nature of the gas. ^c The dimensions and units are those of the corresponding quantity.			

5 Principle of the method of measurement and computation

5.1 Principle of the method of measurement

The principle of the method of measurement is based on the installation of a primary device into a pipeline in which a fluid is running full. The installation of the primary device causes a static pressure difference between the upstream side and the throat or downstream side of the device. The flow rate can be determined from the measured value of this pressure difference and the knowledge of the thermodynamic conditions, fluid properties, meter geometry and meter characteristics. It is assumed that an uncalibrated differential pressure meter is within the geometric and Reynolds number range required for the ISO discharge coefficient prediction to be valid. Alternatively, it is assumed that a bespoke calibrated differential pressure meter is to be used within its calibration range.

The mass flow rate can be determined, since it is related to the differential pressure within the uncertainty limits stated in ISO 5167, using [Formula \(1\)](#):

$$q_m = \frac{C}{\sqrt{1-\beta^4}} \varepsilon A_t \sqrt{2\Delta p \rho_1} \quad (1)$$

NOTE For practical implementation, this formula is expanded upon as Formula (1) of ISO 5167-2, ISO 5167-3, ISO 5167-4, ISO 5167-5 and ISO 5167-6.

Similarly, the value of the volume flow rate can be calculated using [Formula \(2\)](#):

$$q_V = \frac{q_m}{\rho} \quad (2)$$

where ρ is the fluid density at the temperature and pressure for which the volume is stated.

5.2 Method of determination of the required diameter ratio for the selected standard primary device

In practice, when determining the diameter ratio of a primary element to be installed in a given pipeline, C and ε used in [Formula \(1\)](#) are, in general, not precisely known. Hence the following shall be selected *a priori*:

- the type of primary device to be used;
- a flow rate and the corresponding desired value of the differential pressure.

The related values of q_m and Δp are then inserted in [Formula \(1\)](#), rewritten in the form of [Formula \(3\)](#):

$$\frac{C\varepsilon\beta^2}{\sqrt{1-\beta^4}} = \frac{4q_m}{\pi D^2 \sqrt{2\Delta p\rho_1}} \quad (3)$$

in which the diameter ratio of the selected primary device can be determined by iteration (see [Annex A](#)).

For a given flow rate, the uncertainty of the discharge coefficient and that of the predicted differential pressure are directly linked, because the discharge coefficient is proportional to the reciprocal of the square root of the differential pressure. Consequently, care shall be taken when determining β that the maximum differential pressure does not exceed the upper range limit of the transmitter. This is of particular importance where the uncertainty of the discharge coefficient is large.

5.3 Computation of flow rate

Computation of the flow rate, which is a purely arithmetic process, is performed by replacing the different terms on the right-hand side of [Formula \(1\)](#) by their numerical values.

C may be dependent on Re , which is itself dependent on q_m . In such cases the final value of C , and hence of q_m , is obtained by iteration. See [Annex A](#) for guidance regarding the choice of the iteration procedure and initial estimates.

The dimensions used in the formulae are the values of the dimensions at the working conditions. Measurements taken at any other conditions should be corrected for any possible expansion or contraction of the primary device and the pipe due to the values of the temperature and pressure of the fluid during the measurement.

NOTE For corrections due to thermal expansion or contraction see ISO/TR 9464:2008 5.1.6.1.3 and 5.2.6.4.2.

It is necessary to know the density and the viscosity of the fluid at working conditions. In the case of a compressible fluid, it is also necessary to know the isentropic exponent of the fluid at working conditions.

5.4 Determination of density, pressure and temperature

5.4.1 General

Any method of determining reliable values of the density, static pressure and temperature of the fluid is acceptable if it does not interfere with the distribution of the flow in any way at the cross-section where measurement is made.

5.4.2 Density

It is necessary to know the density of the fluid at the upstream pressure tapping; it can either be measured directly or be calculated from an appropriate equation of state from a knowledge of the absolute static pressure, absolute temperature and composition of the fluid at that location.

NOTE ISO/TR 9464:2008, 6.4.2 provides a method for correcting density measured downstream of a device to upstream conditions.

5.4.3 Static pressure

The static pressure of the fluid shall be measured by means of an individual wall pressure tapping, or several such tapplings interconnected, or by means of carrier ring tapplings if they are permitted for the measurement of differential pressure in that tapping plane for the particular primary device.

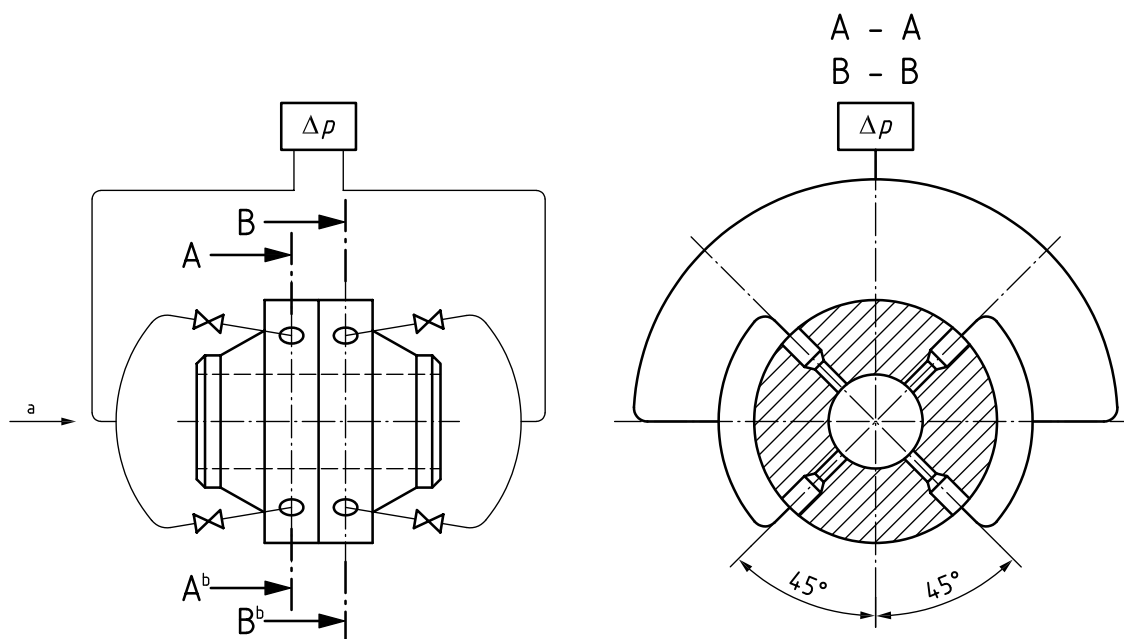

- a Flow.
- b Section A-A (upstream) also typical for section B-B (downstream).

Figure 1 — “Triple-T” arrangement

Where four pressure tapplings are connected together to give the pressure upstream, downstream or in the throat of the primary device, it is best that they should be connected together in a “triple-T” arrangement as shown in [Figure 1](#). The “triple-T” arrangement is often used for measurement with large Venturi tubes.

It is permissible to link simultaneously one pressure tapping with differential pressure measuring device(s) and static pressure measuring device(s), provided that these connections do not lead to any distortion of the differential pressure measurement.

5.4.4 Temperature

5.4.4.1 Temperature measurement requires particular care. The thermometer well or pocket shall take up as little space as possible to avoid reducing the cross-sectional area of the pipe. Thermometer probes should have adequate immersion depth to ensure the fluid temperature is measured accurately.

Except where a cone meter is used, the temperature of the fluid shall preferably be measured downstream of the primary device to avoid disturbance to the flow profile affecting the primary device.

If the thermometer well or pocket is located downstream of the primary device, the distance between it and the primary device shall be at least equal to $5D$ (and at most $15D$ when the fluid is a gas). In the case of a Venturi tube this distance is measured from the throat pressure tapping plane, and the pocket shall also be at least $2D$ downstream from the downstream end of the diffuser section.

If the thermometer well or pocket is located upstream of the primary device it shall be located in accordance with the values given in the applicable part of ISO 5167 describing the primary device.

Within the limits of application of this document, it may generally be assumed that the downstream and upstream temperatures of the fluid are the same at the differential pressure tappings. However, if the fluid is a non-ideal gas, the lowest uncertainty is required, and there is a large pressure loss between the upstream pressure tapping and downstream thermowell, it is then necessary to calculate the upstream temperature from the downstream temperature assuming an isenthalpic expansion between the two points. To perform the calculation, the pressure loss, $\Delta\varpi$, should be calculated from the formulae given in other parts of the ISO 5167 series for that primary device. Then the corresponding temperature drop from the upstream tapping to the downstream temperature location, ΔT , can be evaluated using the Joule Thomson coefficient, μ_{JT} , which is described in 3.3.4 and given in Formula (4):

$$\Delta T = \mu_{JT} \Delta\varpi \quad (4)$$

NOTE 1 Experimental work^[8] has shown that this is an appropriate method for orifice plates. It is reasonably and widely assumed that the method works for all differential pressure meters.

NOTE 2 Although an isenthalpic expansion is assumed between the upstream pressure tapping and the downstream temperature tapping, this is not inconsistent with there being an isentropic expansion between the upstream tapping and the vena contracta or throat.

NOTE 3 Measurement of temperature at a gas velocity in the pipe higher than approximately 50 m/s can lead to additional uncertainty associated with the temperature recovery factor.

5.4.4.2 The temperature of the primary device and that of the fluid upstream of the primary device are assumed to be the same (see 7.1.7).

5.5 Differential pressure flow measurement system

5.5.1 General

A complete differential pressure measuring system comprises several typical components as shown in Figure 2. Alternative configurations are equally acceptable.

The primary device is either mounted into the pipeline directly as shown or, for example in the case of an orifice plate, may be installed in a carrier where the differential pressure tappings are located. Some designs of orifice carrier facilitate the easy removal of the orifice plate for inspection or to change the orifice bore size without having to stop the flow and de-pressurize the system.

Interconnection of multiple tappings shall be as described in 5.4.3.

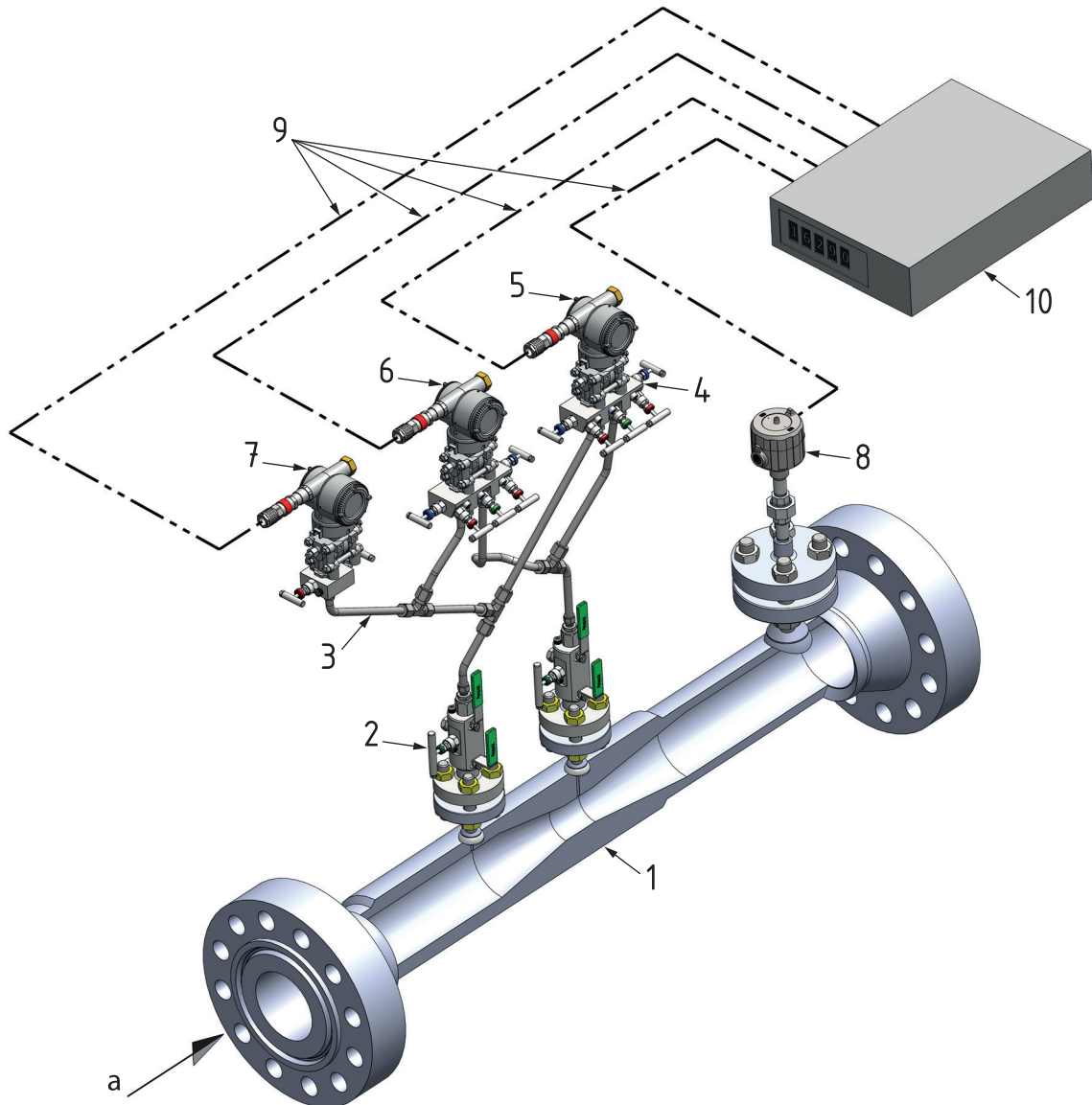

Key

- | | | | |
|---|--|----|--|
| 1 | primary device | 6 | differential pressure transmitter - low range |
| 2 | isolation valves | 7 | pressure transmitter |
| 3 | impulse lines | 8 | temperature element or temperature transmitter |
| 4 | valve manifold | 9 | instrument communication cables |
| 5 | differential pressure transmitter - high range | 10 | flow computer |
| a | Flow. | | |

Figure 2 — Differential pressure flow measurement system

5.5.2 Primary device

ISO 5167-2 to ISO 5167-6 specify the meter geometry and characteristics of a selection of primary devices.

Whilst each primary device may operate satisfactorily for a given application, the selection of the most appropriate primary device for a given installation and range of process conditions should be determined by sound engineering judgement.

5.5.3 Impulse lines and transmitters

Impulse lines are used to transmit the differential pressure created by flow through the primary device to the differential pressure transmitter, which in turn transmits the measured differential pressure value to the flow computer.

Impulse lines also transmit the static pressure at the upstream tapping to the pressure transmitter, which in turn transmits the measured upstream pressure value to the flow computer. Impulse lines should only be used for measuring pressure and differential pressure. They shall not be used continuously for draining, venting, or sampling, as there shall be no flow in the impulse line during normal metering operation.

The position and orientation of the pressure and differential pressure transmitters depend on the fluid being measured. ISO 2186 details the requirements for connecting the impulse lines to the differential pressure transmitter for fluids in both horizontal and vertical piping installations.

A temperature element or temperature transmitter provides the measured temperature to the flow computer.

A multivariable transmitter may be used to measure more than one process parameter.

5.5.4 Impulse line isolation valves and valve manifolds

Isolation valves enable the differential pressure transmitter and pressure transmitter to be isolated from the main process line for maintenance purposes. The valve manifold is used to allow the differential pressure transmitter to be isolated and equalised for zero differential pressure checks, venting and maintenance purposes.

5.5.5 Flow computer

The computation of the flow rates from a differential pressure metering system is generally performed within a digital flow computer. This may be a separate “flow computer” device, or part of an integrated control system. Additional calculations may be carried out, including totalisation, diagnostics, and communications with other distributed systems.

5.6 Differential pressure flow measurement system design considerations

5.6.1 Flow rate turndown and stacked transmitters

The flow range of a flow meter is commonly described as the “turndown” (see [Annex D](#)).

It is common to connect two or more differential pressure transmitters of different calibrated ranges across the primary device to measure a wider range of flow rate; this is known as “stacking” the transmitters. The connection can be made on the same pair of tapings or on additional pairs of tapings located circumferentially around the primary device.

Some installations may duplicate the differential pressure transmitters using common or separate tapings in the same planes for redundancy or verification.

The flow computer shall be configured to select the in-range transmitter when performing the flow computations. The associated uncertainty shall be calculated using the in-use transmitter.

5.6.2 Meter calibration

Where a user of an ISO 5167 flow metering system requires a lower discharge coefficient uncertainty than that stated in the relevant part associated with that primary element, or where the geometry differs from that described in that part, the meter shall be calibrated in accordance with [Clause 7](#) of the applicable part of ISO 5167.

The purpose of the flow calibration is to determine the discharge coefficient of an individual flow meter and its associated uncertainty. The meter calibration data shall not be transferred between different flow meters, even of the same nominal geometry.

Where the flow metering system geometry differs from that described in the applicable part of ISO 5167, the associated expansibility formula may require verification.

The meter calibration data can be used to apply an adjustment to the discharge coefficient value used within the associated flow computer. Possible methods of applying the adjusted discharge coefficient include:

- updated averaged single value;
- multi-point linearization algorithm (piecewise linear interpolation);
- polynomial algorithm.

A calibrated meter shall only be used within the calibrated Reynolds number range. The uncertainty outside the calibrated range is undefined.

NOTE For gas applications (other than those at ambient process conditions), an ambient-temperature water calibration is unlikely to produce the in-service Reynolds number range. The in-service Reynolds number range is used to help determine the choice of test facility.

5.6.3 Permanent pressure loss

The permanent pressure loss of a metering system is the pressure loss caused by its insertion into a piping installation. Typically, it is assumed that the pressure is measured from a tapping D upstream of the metering system to a second tapping $6D$ downstream of the metering system. The permanent pressure loss is smaller than the primary element differential pressure owing to pressure recovery within the flow meter.

The permanent pressure loss of any metering system includes the effects due to all elements of the metering system that cause a difference in the flow when compared with straight pipe of the nominal upstream (and downstream) diameter. All elements that intrude into the flow (including primary elements, flow conditioners and thermowells) or otherwise cause deviation of the flow (including flange joints, pipe diameter changes, and other fittings) will induce a change in pressure.

The permanent pressure loss across the primary device is evaluated in the following sections:

- Orifice plates ISO 5167-2:2022, 5.4
- Nozzles ISO 5167-3:2022, 5.1.8, 5.2.8, 5.3.8 and 5.4.6
- Venturi tubes ISO 5167-4:2022, 5.9
- Cone meters ISO 5167-5:2022, 5.9
- Wedge meters ISO 5167-6: 2022, 5.9.

In the case of the Venturi tube and the Venturi nozzle the pressure loss that would have been caused by straight pipe if the Venturi tube or Venturi nozzle had not been installed is calculated^[2] and subtracted from the measured pressure loss to give the values in ISO 5167-3:2022, 5.4.6 and ISO 5167-4:2022, 5.9. This method is used because for these primary elements the calculated pipe loss is a significant fraction of the measured pressure loss.

It should be noted that the permanent pressure loss of a metering system is only one component in the overall pressure loss across a total piping installation, i.e., the metering system permanent pressure loss may be small compared with the major pipe losses.

An example of a permanent pressure loss calculation for a measurement system is given in [Annex F](#).

The permanent pressure loss shall also be considered as part of the primary element's "sizing" (including the meter type, size and β). To size the meter to remain beneath a given maximum pressure loss may reduce the flow rate turndown of the meter for the conditions the meter will see in service.

5.6.4 Diagnostics and meter verification

Differential pressure meters may include diagnostics systems with additional functionality to provide assurance of the flow measurement, highlight potential installation issues, or indicate erroneous readings due to adverse conditions (such as hydrates). These may include:

- digital differential pressure transmitter internal diagnostic parameters;
- intercomparison of multiple transmitters on the same measurement;
- comparison of combinations of measurements across the flow meter;
- axial pressure profile analysis;
- internal or external data validation and reconciliation (DVR) techniques, including time-based or statistical evaluation of parameters.

Secondary variable data from digital differential pressure transmitters can also provide additional data for use in diagnostic systems.

Verification systems can be supported by diagnostic checks to facilitate predictive maintenance for the flow metering system and the associated assets. Some sections of industry are moving from flow meter routine scheduled maintenance schemes, i.e. periodic maintenance checks regardless of the state of the system, to Condition Based Monitoring schemes (CBM), i.e. only performing maintenance when it is required.

5.6.5 Overall uncertainty of differential pressure metering system

The calculation of the overall uncertainty for a differential pressure metering system shall be performed in line with the guidance given in ISO 5168 and ISO/IEC Guide 98-3. [8.3](#) provides pertinent information on the practical computation of uncertainty. A supporting example is given in [Annex E](#).

6 General requirements for the measurements

6.1 Primary device

6.1.1 The primary device shall be manufactured, installed and used in accordance with the applicable part of the ISO 5167 series.

When the manufacturing characteristics or conditions of use of the primary devices are outside the limits given in the applicable part of ISO 5167, it may be necessary to calibrate the primary device separately under the actual conditions of use.

Furthermore, a primary device with characteristic and flow conditions within the limits given in the applicable part of ISO 5167 can have its uncertainty further reduced by a flow calibration.

6.1.2 The condition of the primary device and differential pressure transmitters shall be periodically checked so that conformity with the applicable part of ISO 5167 is maintained.

6.1.3 The primary device shall be manufactured from material whose coefficient of thermal expansion is known.

6.2 Nature of the fluid

6.2.1 The fluid may be either compressible or considered as being incompressible.

6.2.2 The fluid shall be such that it can be considered as being physically and thermally homogeneous and single-phase.

6.3 Flow conditions

6.3.1 ISO 5167 (all parts) does not provide for the measurement of pulsating flow, which is the subject of ISO/TR 3313. The flow rate shall be constant or, in practice, vary only slightly and slowly with time.

The flow is considered as not being pulsating^[10] when [Formula \(5\)](#) is satisfied:

$$\frac{\Delta p'_{\text{rms}}}{\overline{\Delta p}} \leq 0,10 \quad (5)$$

where

$\overline{\Delta p}$ is the time-mean value of the differential pressure;

$\Delta p'$ is the fluctuating component of the differential pressure;

$\Delta p'_{\text{rms}}$ is the root mean square value of $\Delta p'$;

$\Delta p'_{\text{rms}}$ can only be measured accurately using a fast-response differential pressure sensor; moreover, the whole secondary system should conform to the design recommendations specified in ISO/TR 3313. It will not, however, normally be necessary to check that this condition is satisfied.

6.3.2 ISO 5167 is only applicable where there is no change of phase through the primary device. In cases where the thermodynamic conditions in the metering system are close to the phase boundary, increasing the throat area of the primary element will reduce the differential pressure, which may prevent a change of phase.

For liquids, the pressure shall not fall below the vapour pressure of the liquid (otherwise cavitation will result).

For gases, it is only necessary to calculate the temperature at the throat if the gas is in the vicinity of its dew-point; the temperature at the throat may be calculated assuming an isentropic expansion from the upstream conditions (the upstream temperature may need to be calculated in accordance with the formula in [5.4.4.1](#)); the temperature and pressure in the throat should be such that the fluid is in the single-phase region.

6.3.3 If the fluid is a gas, the pressure ratio as defined in [3.1.4](#) shall be greater than or equal to 0,75.

7 Installation requirements

7.1 General

7.1.1 The method of measurement applies only to fluids flowing through a pipeline of circular cross-section.

7.1.2 The pipe shall run full at the measurement section.

7.1.3 The primary device shall be fitted between two straight sections of cylindrical pipe of constant diameter and of specified minimum lengths in which there is no obstruction or branch connection other than those specified in [Clause 6](#) of the applicable part of ISO 5167 for that primary device.

The pipe is considered straight when the deviation from a straight line does not exceed 0,4 % over its length. Normally visual inspection is sufficient. Flanges are permitted in the straight sections of pipe upstream and downstream of the primary device. The flanges shall be aligned in such a way that they do not introduce deviation from a straight line of more than 0,4 %. The minimum straight lengths of pipe conforming to the above requirement necessary for a particular installation, vary with the type and specification of the primary device and the nature of the pipe fittings involved.

7.1.4 The pipe bore shall be circular over the entire minimum length of straight pipe required. The cross-section may be taken to be circular if it appears so by visual inspection. The circularity of the outside of the pipe can be taken as a guide, except in the immediate vicinity ($2D$) of the primary device where special requirements shall apply according to the type of primary device used.

Seamed pipe may be used provided that the internal weld bead is parallel to the pipe axis throughout the entire length of the pipe required to satisfy the installation requirements for the primary device being used. Any weld bead shall not have a height greater than the permitted step in diameter. Unless an annular slot is used, the seam shall not be situated within any sector of $\pm 30^\circ$ centred on any individual pressure tapping to be used in conjunction with the primary device. If an annular slot is used, the location of the seam is not significant. If spirally wound pipe is used, then it shall be machined to a smooth bore.

7.1.5 The interior of the pipe shall be clean at all times.

The acceptable value of pipe roughness depends on the primary device. In each case there are limits on the value of the arithmetical mean deviation of the roughness profile, Ra .

The internal surface roughness of the pipe should be measured at approximately the same axial locations as those used to determine and verify the pipe internal diameter. A minimum of four roughness measurements shall be made to define the pipe internal surface roughness. The roughness can change with time as stated in [6.1.2](#), and this should be taken into account in establishing the frequency of cleaning the pipe or checking the value of Ra .

An approximate value of Ra may be obtained by assuming that Ra is equal to k_a / π , where k_a is the uniform equivalent roughness as given on the Moody diagram (see Reference [9]). The value of k_a is given directly by a pressure loss test of a sample length of pipe, using the Colebrook-White Equation (see [7.4.1.5](#)) to calculate the value of k_a from the measured value of friction factor. Approximate values of k_a for different materials can also be obtained from the various tables given in reference literature, and [Table B.1](#) gives values of k_a for a variety of materials.

7.1.6 The pipe may be provided with drain holes and/or vent holes to permit the removal of solid deposits and entrained fluids. However, the drain or vent system shall not intrude into the pipeline, and there shall be no flow through either drain holes or vent holes during the flow measurement process.

Drain and vent holes should not be located near to the primary device. Where it is not possible to conform to this, the diameter of these holes shall be less than $0,08D$ and they shall be located so that the minimum distance, measured on a straight line from each of these holes to a pressure tapping of the primary device on the same side as the holes, is greater than $0,5D$. The centreline of a pressure tapping and the centreline of a drain or vent hole shall be offset from each other by at least 30° relative to the axis of the pipe.

7.1.7 Insulation of the meter may be required in the case of temperature differences between the ambient temperature and the temperature of the flowing fluid which are significant given the

uncertainty of measurement required. This is particularly true in the case of fluids being metered near their critical point where small temperature changes result in major density changes.

Temperature differences can be important at low flow rates, where heat transfer effects may cause distorted temperature profiles, for example, stratification of temperature layers from top to bottom. There may also be a change in the mean temperature value from the upstream to the downstream side of the meter run.

7.2 Minimum upstream and downstream straight lengths

7.2.1 The primary device shall ideally be installed in the pipeline at a position such that the flow conditions immediately upstream of the primary device approximate to those of swirl-free, fully developed pipe flow. Conditions meeting this requirement are specified in [7.3](#).

In practice, the primary device shall be installed in the pipeline at a position such that the flow conditions immediately upstream of the primary device are acceptable for that primary device. Conditions meeting this requirement are created by the minimum lengths stated in Clause 6 of ISO 5167-2:2022, ISO 5167-3:2022, ISO 5167-4:2022, ISO 5167-5:2022 or ISO 5167-6:2022.

7.2.2 However, a flow conditioner as described in [7.4](#) will permit the use of much shorter upstream pipe lengths. Such a flow conditioner shall be installed upstream of the primary device where sufficient straight length, to achieve the desired level of uncertainty, is not available.

7.3 General requirement for flow conditions at the primary device

7.3.1 Requirement

If the specified conditions given in Clause 6 of ISO 5167-2:2022, ISO 5167-3:2022, ISO 5167-4:2022, ISO 5167-5:2022 or ISO 5167-6:2022 cannot be met, the applicable part of ISO 5167 remains valid if the flow conditions at the primary device can be demonstrated to conform to swirl-free fully developed flow over the entire Reynolds number range of the flow measurement process.

NOTE If [7.3.2](#) and [7.3.3](#) are satisfied, then the flow conditions are acceptable for primary devices of sufficiently small β . From the limited data available, it is recognized that primary devices of smaller β are less susceptible to changes in velocity profile.

7.3.2 Swirl-free conditions

Swirl-free conditions can be presumed to exist when the swirl angle at all points over the pipe cross-section is less than 2° .

7.3.3 Good velocity profile conditions

Good velocity profile conditions can be presumed to exist when, at each point across the pipe cross-section, the ratio of the local axial velocity to the maximum axial velocity at the cross-section agrees to within 5 % with that which would be achieved in swirl-free flow at the same radial position at a cross-section located at the end of a very long straight length (over $100D$) of similar pipe (fully developed flow).

7.4 Flow conditioners

7.4.1 Compliance testing

7.4.1.1 Provided that a flow conditioner (see also [Annex C](#)) has passed the compliance test in [7.4.1.2](#) to [7.4.1.6](#) for a particular primary device, the flow conditioner may be used with the same type of primary device with any value of diameter ratio up to 0,67 downstream of any upstream fitting. Provided that

the distance between the flow conditioner and the primary device and that between the upstream fitting and the flow conditioner are in accordance with [7.4.1.6](#) and the downstream straight length is in accordance with the requirements for the particular primary device (ISO 5167-2:2022, column 14 of Table 3, ISO 5167-3:2022, column 12 of Table 3, ISO 5167-4:2022, the text in Table 1, ISO 5167-5:2022, 6.2.1 or ISO 5167-6:2022, 6.2), it is not necessary to increase the uncertainty of the discharge coefficient to take account of the installation.

7.4.1.2 Using a primary device of diameter ratio 0,67 the shift in discharge coefficient from that obtained in a long straight pipe shall be less than 0,23 % when the flow conditioner is installed in each of the following situations:

- a) in good flow conditions;
- b) downstream of a 50 % closed gate valve (or a D-shaped orifice plate);
- c) downstream of a device producing a high swirl (the device should produce a maximum swirl angle across the pipe of at least 24° at a distance 18*D* downstream of it or at least 20° at a distance 30*D* downstream of it). The swirl may be generated by a swirler or by other means. An example of a swirler is the unpatented Chevron Swirler given as [Figure C.1](#).

Upstream of the fittings in b) and c) there shall be a length of straight pipe which is sufficiently long that the primary device is not affected by any fittings upstream of those specified in b) or c).

7.4.1.3 Using a primary device of diameter ratio 0,4, the shift in discharge coefficient from that obtained in a long straight pipe shall be less than 0,23 % when the flow conditioner is installed downstream of the same fitting as in [7.4.1.2](#) c).

NOTE This test is included in case there is still swirl downstream of the conditioner. The swirl can have more effect on the discharge coefficient for $\beta = 0,4$ than for $\beta = 0,67$.

7.4.1.4 To establish the acceptability of both the test facility and the primary devices with which the test is being conducted the baseline discharge coefficient for each primary device, as measured in a long straight pipe by the test facility, shall lie within the expanded uncertainty limits (at 95 % confidence level) of the discharge coefficient equation for that primary device.

For these tests, the test facility should first remove swirl and then have a sufficient length upstream of the primary device.

For example, a 70*D* upstream length should be sufficient for an orifice plate.

7.4.1.5 If the flow conditioner is to be acceptable at any Reynolds number then it is necessary to establish that it not only meets [7.4.1.2](#) and [7.4.1.3](#) at one Reynolds number, but that it meets a) or b) or c)

from 7.4.1.2 at a second Reynolds number. If the two pipe Reynolds numbers are Re_{low} and Re_{high} then they shall meet the following criteria:

$$10^4 \leq Re_{low} \leq 10^6 \text{ and } Re_{high} \geq 10^6$$

and:

$$\lambda(Re_{low}) - \lambda(Re_{high}) \geq 0,0036,$$

where λ is the pipe friction factor (see Reference [9]), which may be obtained graphically from the Moody diagram or from the Colebrook-White equation:

$$\frac{1}{\sqrt{\lambda}} = 1,74 - 2 \lg \left(\frac{2k_a}{D} + \frac{18,7}{Re_D \sqrt{\lambda}} \right)$$

with k_a evaluated as πRa .

NOTE 1 Following ISO 80000-2, \log_{10} is written lg.

If it is only desired to use the flow conditioner for $Re_D > 3 \times 10^6$, it is sufficient to carry out the test in 7.4.1.2 at a single value of Re_D greater than 3×10^6 .

If the flow conditioner is to be acceptable for any pipe size, then it is necessary to establish that it not only meets 7.4.1.2 and 7.4.1.3 at one pipe size, but that it meets a) or b) or c) from 7.4.1.2 at a second pipe size. If the two pipe diameters are D_{small} and D_{large} then they shall meet the following criteria:

$$D_{small} \leq 110 \text{ mm (nominal 4 inch) and } D_{large} \geq 190 \text{ mm (nominal 8 inch).}$$

NOTE 2 The requirements on friction factor are determined in order that for an orifice plate, the velocity profile changes sufficiently that the discharge coefficient changes by at least twice the maximum permitted shift in discharge coefficient due to installation. From References [11] to [13] the effect of change in friction factor is given by

$$\Delta C = 3,134\beta^{3,5}\Delta\lambda$$

Taking $C = 0,6$ and the minimum required change in C as $1,26\beta - 0,384$ % for $\beta \geq 0,67$ gives

$$\Delta\lambda \geq \frac{0,00241\beta - 0,000735}{\beta^{3,5}}$$

NOTE 3 Although for a nozzle the effect of $\Delta\lambda$ on C will be different from its effect on an orifice plate, the required values of Reynolds number for the compliance test still appear to be appropriate.

Where it is not possible (or not practical) to achieve $\lambda(Re_{low}) - \lambda(Re_{high}) \geq 0,0036$ within the range of Reynolds number permitted for a particular primary device, a flow conditioner will be acceptable over that range provided that it has passed the compliance test at a single Reynolds number.

7.4.1.6 The range of distances between the flow conditioner and the primary device and that between the upstream fitting and the flow conditioner which are used in the tests will determine the acceptable ranges of distances when the flow meter is used. The distances shall be expressed in terms of numbers of pipe diameters.

7.4.1.7 If it is desired to carry out compliance testing for a flow conditioner for use up to a value of β which is greater than 0,67, then first it shall be shown to meet 7.4.1.2 to 7.4.1.5. Then the test described in 7.4.1.2, 7.4.1.4 and 7.4.1.5 shall be carried out at the maximum value of β over which the conditioner is

to be used, β_{\max} . The permitted shift in discharge coefficient is increased to $(0,63\beta_{\max} - 0,192)$ %. In the case of [7.4.1.5](#).

$$\lambda(Re_{\text{low}}) - \lambda(Re_{\text{high}}) \geq \frac{0,002\,41\beta_{\max} - 0,000\,735}{\beta_{\max}^{3,5}}$$

Then, provided that the conditioner meets the compliance test in all the above tests, it has passed the compliance test for $\beta \leq \beta_{\max}$. The acceptable ranges of distances between the flow conditioner and the primary device and between the upstream fitting and the flow conditioner are determined as in [7.4.1.6](#).

7.4.2 Specific test

If a compliance test has not been carried out to permit the use of a flow conditioner downstream of any upstream fitting it may be necessary to carry out a specific flow test. The test will be deemed satisfactory if a test of that installation shows that the shift in discharge coefficient from that obtained in a long straight pipe is less than 0,23 %. The permitted shift in discharge coefficient can be increased to $(0,63\beta - 0,192)$ % for $0,67 < \beta \leq 0,75$ (or $0,67 < \beta \leq 0,8$ in the case of a nozzle or $0,67 < \beta \leq 0,775$ in the case of a Venturi nozzle). In this situation, it is not necessary to increase the uncertainty of the discharge coefficient to take account of the installation.

8 Uncertainties on the measurement of flow rate

8.1 General

More comprehensive information for calculation of the uncertainty of a measurement of flow rate, together with an example, is given in ISO 5168. Information on the calculation of uncertainties is given in ISO/IEC Guide 98-3.

The uncertainty of the flow rate measurement is not constant across the range of the flow meter and should be evaluated at all relevant sets of conditions.

8.2 Definition of uncertainty

8.2.1 For the purposes of ISO 5167 (all parts) the expanded uncertainty is defined as an interval about the result of a measurement that may be expected to encompass approximately 95 % of the distribution of values that could reasonably be attributed to the measurand.

8.2.2 The expanded uncertainty on the measurement of the flow rate shall be calculated and given under this name whenever a measurement is claimed to be in conformity with the applicable part of ISO 5167.

8.2.3 The uncertainty can be expressed in absolute or relative terms and the result of the flow measurement can then be given in any one of the following forms, as in [Formulae \(6\)](#), [\(7\)](#) and [\(8\)](#):

$$\text{flow rate} = q \pm U_q \text{ with a 95 \% confidence level} \quad (6)$$

$$\text{flow rate} = q(1 \pm U'_q) \text{ with a 95 \% confidence level} \quad (7)$$

$$\text{flow rate} = q \text{ within } (100U'_q) \% \text{ with a 95 \% confidence level} \quad (8)$$

where the uncertainty U_q has the same dimensions as q while $U'_q = U_q / q$ is dimensionless.

8.2.4 For convenience a distinction is made between the uncertainties linked to measurements made by the user and those linked to quantities specified in the applicable part of ISO 5167. The latter uncertainties are on the discharge coefficient and the expansibility [expansion] factor; they give the minimum uncertainty with which the measurement is unavoidably tainted, since the user has no control over these values. They occur because small variations in the geometry of the device are allowed and because the investigations on which the values have been based could not be made under “ideal” conditions, nor without some uncertainty.

8.3 Practical computation of the uncertainty

8.3.1 Component uncertainties

8.3.1.1 From [Formula \(1\)](#), the computation of the mass flow rate q_m is given by:

$$q_m = C \varepsilon A_t \frac{\sqrt{2 \Delta p \rho_1}}{\sqrt{1 - \beta^4}}$$

In fact, the various quantities which appear on the right-hand side of this equation are not independent, so that it is not correct to compute the uncertainty of q_m directly from the uncertainties of these quantities.

For example, C is a function of the throat and pipe dimensions, V_1 , μ_1 and ρ_1 , and ε is a function of the throat and pipe dimensions, Δp , p_1 and κ .

8.3.1.2 As this interrelationship provides relatively insignificant correlation in the estimation of uncertainty, it is sufficient, for most practical purposes, to assume that the uncertainties of C , ε , throat dimension, Δp and ρ_1 are independent of each other.

8.3.1.3 A calculation of U'_{q_m} , the relative expanded uncertainty of q_m , can then be performed, which takes account of the interdependence of C on throat and pipe dimensions which enters into the calculation as a consequence of the dependence of C on β . Note that C is also dependent on the Reynolds number Re_D . However, the deviations of C due to these influences are of a second order and are included in the uncertainty on C when derived from equations given within the parts of ISO 5167.

Similarly, the deviations of ε which are due to uncertainties in the value of β , the pressure ratio and the isentropic exponent are also of a second order and are included in the uncertainty of ε . The contribution to the uncertainty due to the covariance terms may be negligible.

8.3.1.4 The uncertainties which shall be included in the calculation of U'_{q_m} are therefore those of the quantities C , ε , throat and pipe dimensions, Δp and ρ_1 .

8.3.2 Practical working formula

8.3.2.1 Uncertainties in the other parts of ISO 5167 are relative expanded uncertainties with a confidence level of approximately 95 %. To combine them it is necessary first to calculate u' , the relative standard uncertainty of each contribution, which is obtained by dividing U' , the relative expanded uncertainty of each contribution, by k , where k is equal to 2 where the contribution has a normal probability distribution and equal to $\sqrt{3}$ where the contribution has a rectangular probability distribution.

NOTE k is the coverage factor: see ISO/IEC Guide 98-3:2008, 2.3.6.

The practical working formula for the relative standard uncertainty of the mass flow rate, u'_{q_m} , is given by:

[Formula \(9\)](#) for orifice plates (ISO 5167-2), nozzles (ISO 5167-3) and Venturi tubes (ISO 5167-4); [Formula \(10\)](#) for cone meters (ISO 5167-5, where d_c is the cone diameter); [Formula \(11\)](#) for wedge meters (ISO 5167-6, where h is the wedge gap).

$$u'_{q_m} = \sqrt{u'^2_C + u'^2_\varepsilon + \left(\frac{2\beta^4}{1-\beta^4}\right)^2 u'^2_D + \left(\frac{2}{1-\beta^4}\right)^2 u'^2_d + \left(\frac{1}{2}\right)^2 u'^2_{\Delta p} + \left(\frac{1}{2}\right)^2 u'^2_{\rho_1}} \quad (9)$$

$$u'_{q_m} = \sqrt{u'^2_C + u'^2_\varepsilon + \left[\frac{2(1+\beta^2+\beta^4)}{\beta^2(1+\beta^2)}\right]^2 u'^2_D + \left[\frac{2}{\beta^2(1+\beta^2)}\right]^2 u'^2_{d_c} + \left(\frac{1}{2}\right)^2 u'^2_{\Delta p} + \left(\frac{1}{2}\right)^2 u'^2_{\rho_1}} \quad (10)$$

$$u'_{q_m} = \sqrt{u'^2_C + u'^2_\varepsilon + \left[2 - \frac{8\frac{h}{D}\sqrt{\frac{h}{D} - \left(\frac{h}{D}\right)^2}}{\pi\beta^2(1-\beta^4)}\right]^2 u'^2_D + \left[\frac{8\frac{h}{D}\sqrt{\frac{h}{D} - \left(\frac{h}{D}\right)^2}}{\pi\beta^2(1-\beta^4)}\right]^2 u'^2_h + \left(\frac{1}{2}\right)^2 u'^2_{\Delta p} + \left(\frac{1}{2}\right)^2 u'^2_{\rho_1}} \quad (11)$$

To use these Formulae, some of the uncertainties, such as those on the discharge coefficient and expansibility [expansion] factor, are given in [8.3.2.2](#) and [8.3.2.3](#), while others shall be determined by the user (see [8.3.2.4](#) and [8.3.2.5](#)).

An example is given in [Annex E](#).

8.3.2.2 For [Formulae \(9\),\(10\)](#) and [\(11\)](#) the values of U'_C and of U'_ε shall be taken from the applicable part of ISO 5167 when C and ε are derived from equations given within the applicable part of ISO 5167. The discharge coefficient and expansibility are both assumed to have normal distributions: so, $u'_C = U'_C / 2$ and $u'_\varepsilon = U'_\varepsilon / 2$.

8.3.2.3 When the straight lengths are such that an additional uncertainty of 0,5 % is to be considered, this additional relative uncertainty shall be added arithmetically to the relative expanded uncertainty of C in accordance with the requirements given in ISO 5167-2:2022, 6.2.4, ISO 5167-3:2022, 6.2.4 and ISO 5167-4:2022, 6.2.4 and not quadratically as with the other uncertainties in [Formula \(9\)](#). Other additional uncertainties (see ISO 5167-2:2022, 6.4.4 and 6.5.3 and ISO 5167-3:2022, 6.4.4) shall be added arithmetically in the same way.

8.3.2.4 For [Formula \(9\)](#), the values of U'_D and U'_d shall be determined from the uncertainty of the devices used to measure the pipe and throat dimensions, and from the permissible variation given in ISO 5167-2:2022, 6.4.1, ISO 5167-3:2022, 6.4.1 and ISO 5167-4:2022, 5.2.2 and ISO 5167-2:2022, 5.1.8, ISO 5167-3:2022, 5.1.2.5, 5.2.2.3, 5.3.2.4 and 5.4.1.6 and ISO 5167-4:2022, 5.2.4 respectively. Alternatively, instead of the permissible variation, the smaller actual variation can be computed by the user.

If the variation in D and d is presumed to follow a rectangular distribution $u'_D = U'_D / \sqrt{3}$ and $u'_d = U'_d / \sqrt{3}$.

A similar method shall be used for [Formulae \(10\)](#) and [\(11\)](#).

8.3.2.5 The values of $U'_{\Delta p}$ and U'_{ρ_1} shall be determined by the user because the applicable part of ISO 5167 does not specify in detail the method of measurement of the quantities Δp and ρ_1 . The uncertainties in the measurement of both quantities may include components stated by manufacturers as a percentage of full scale. Calculation of percentage uncertainty below full scale shall reflect this increased percentage uncertainty.

8.3.2.6 Temperature and pressure measurements do not appear directly in the equations for mass flow. They are however vital in the determination of density and potentially Reynolds number through viscosity. They may also provide a small uncertainty to the other components, for example, through temperature expansion of the dimensions.

8.3.2.7 The relative expanded uncertainty U'_{q_m} is then given by $U'_{q_m} = 2u'_{q_m}$.

Annex A (informative)

Iterative computations

An iterative computation procedure is required when a problem cannot be solved by direct calculation methods (see 5.3). Independent validation of software for flow metering calculations is recommended.

Taking the case for orifice plates for instance, iterative computations are always required to calculate:

a) **For the case of predicting the operating meter's mass flow rate:**

— the flow rate q_m at given values of μ_1 , ρ_1 , D , Δp and d .

b) **For the case of meter sizing:**

— the orifice diameter d and β at given values of μ_1 , ρ_1 , D , Δp and q_m ;

— the differential pressure Δp at given values of μ_1 , ρ_1 , D and d and q_m ;

— the diameters D and d at given values of μ_1 , ρ_1 , β , Δp , and q_m .

The principle is to regroup in one member all known values of the basic flow rate [Formula \(1\)](#):

$$q_m = C\varepsilon \frac{\pi}{4} d^2 (1 - \beta^4)^{-0,5} (2\Delta p \rho_1)^{0,5}$$

and the unknown values in the other member.

The known member is then the “invariant” (denoted “ A_n ” in [Table A.1](#)) of the problem.

Then a first guess X_1 is introduced into the unknown member and results in a difference δ_1 between the two members. Iterative computation enables a second guess X_2 to be substituted to obtain δ_2 .

Then X_1 , X_2 , δ_1 and δ_2 are entered into a linear algorithm which computes X_3 ... X_n and δ_3 ... δ_n until $|\delta_n|$ is smaller than a given value, or until two successive values of X or of δ are seen to be “equal” for a given precision.

An example of a linear algorithm with rapid convergence is [formula \(A.1\)](#):

$$X_n = X_{n-1} - \delta_{n-1} \frac{X_{n-1} - X_{n-2}}{\delta_{n-1} - \delta_{n-2}} \tag{A.1}$$

The use of a linear algorithm reduces only slightly the number of calculations from those required using successive substitutions in the case of computations found in applications relative to this document.

Note that the values of d , D and β to be introduced in the calculations are those prevailing under the “working conditions” (see 5.3).

For meters where the primary element and meter body are made of different materials with different thermal expansion coefficients, it is possible that the variation in β due to the working temperature is not negligible.

Examples of full schemes for iterative computations are given in [Table A.1](#).

NOTE C_∞ is the discharge coefficient at infinite Reynolds number.

Table A.1 — Schemes for iterative computation

Problem	$q =$	$\beta =$	$\Delta p =$	$D =$
At given values of	$\mu_1, \rho_1, D, \beta, \Delta p$	$\mu_1, \rho_1, D, q_m, \Delta p$	$\mu_1, \rho_1, D, \beta, q_m$	$\mu_1, \rho_1, \beta, q_m, \Delta p$
Please find	q_m and q_V	throat dimension and β	Δp	D and throat dimension
Invariant "A" _n	$A_1 = \frac{\varepsilon (D\beta)^2 \sqrt{2\Delta p\rho_1}}{\mu_1 D \sqrt{1-\beta^4}}$	$A_2 = \frac{\mu_1 Re_D}{D \sqrt{2\Delta p\rho_1}}$	$A_3 = \frac{8(1-\beta^4)}{\rho_1} \left(\frac{q_m}{C\pi(D\beta)^2} \right)^2$	$A_4 = \frac{4\varepsilon\beta^2 q_m \sqrt{2\Delta p\rho_1}}{\pi\mu_1^2 \sqrt{1-\beta^4}}$
Iteration formula	$\frac{Re_D}{C} = A_1$	$\frac{C\varepsilon\beta^2}{\sqrt{1-\beta^4}} = A_2$	$\frac{\Delta p}{\varepsilon^{-2}} = A_3$	$\frac{Re_D^2}{C} = A_4$
Variable in linear algorithm	$X_1 = Re_D = CA_1$	$X_2 = \frac{\beta^2}{\sqrt{1-\beta^4}} = \frac{A_2}{C\varepsilon}$	$X_3 = \Delta p = \varepsilon^{-2} A_3$	$X_4 = Re_D = \sqrt{CA_4}$
Precision criterion (where n is chosen by the user)	$\left \frac{A_1 - \frac{X_1}{C}}{A_1} \right < 1 \times 10^{-n}$	$\left \frac{A_2 - X_2 C \varepsilon}{A_2} \right < 1 \times 10^{-n}$	$\left \frac{A_3 - \frac{X_3}{\varepsilon^{-2}}}{A_3} \right < 1 \times 10^{-n}$	$\left \frac{A_4 - \frac{X_4^2}{C}}{A_4} \right < 1 \times 10^{-n}$
First guess	$C = C_\infty$	$C = 0,6$ (orifice plate), $C = 1$ (other primary devices) $\varepsilon = 1$	$\varepsilon = 1$	$C = C_\infty$ $D = \infty$ (if flange tappings)
Results	$q_m = \frac{\pi}{4} \mu_1 D X_1$ $q_V = \frac{q_m}{\rho_1}$	$\beta = \left(\frac{X_2^2}{1 + X_2^2} \right)^{0,25}$ Throat dimension is calculated	$\Delta p = X_3$ If the fluid is a liquid, Δp is obtained in first loop	$D = \frac{4q_m}{\pi\mu_1 X_4}$ Throat dimension is calculated

Annex B (informative)

Examples of values of the pipe wall uniform equivalent roughness, k_a

Table B.1 — Values of k_a

Values in millimetres

Material	Condition	k_a	Ra
Brass, copper, aluminium, plastics, glass	smooth, without sediment	<0,03	<0,01
Steel	new, stainless	<0,03	<0,01
	new, seamless cold drawn	<0,03	<0,01
	new, seamless hot drawn new, seamless rolled new, welded longitudinally	≤0,10	≤0,03
	new, welded spirally	0,10	0,03
	slightly rusted	0,10 to 0,20	0,03 to 0,06
	rusty	0,20 to 0,30	0,06 to 0,10
	encrusted	0,50 to 2	0,15 to 0,6
	with heavy encrustation	>2	>0,6
	bituminized, new	0,03 to 0,05	0,01 to 0,015
	bituminized, normal	0,10 to 0,20	0,03 to 0,06
	galvanized	0,13	0,04
	Cast iron	new	0,25
rusty		1,0 to 1,5	0,3 to 0,5
encrusted		>1,5	>0,5
bituminized, new		0,03 to 0,05	0,01 to 0,015
Asbestos cement	coated and not coated, new	<0,03	<0,01
	not coated, normal	0,05	0,015
NOTE In this case, Ra has been calculated on the basis that $Ra \approx \frac{k_a}{\pi}$.			

Annex C (informative)

Flow conditioners and flow straighteners

C.1 General

Flow conditioners can be classified as either true flow conditioners or flow straighteners. In ISO 5167 (all parts), other than in this annex, the term “flow conditioner” is used to describe both true flow conditioners and flow straighteners.

Devices that have been shown to have passed the compliance test in [7.4.1](#) with any particular primary device are shown in the appropriate parts of ISO 5167. It is not intended that the descriptions of flow straighteners and flow conditioners given there should limit the use of other designs which have been tested and proved to provide sufficiently small shifts in discharge coefficient when compared with discharge coefficients obtained in a long straight pipe.

C.2 Flow straighteners

A flow straightener is a device which removes or significantly reduces swirl but may not simultaneously produce the flow conditions specified in [7.3.3](#).

Examples of flow straighteners are the tube bundle flow straightener, the AMCA straightener and the Étoile straightener.

A special case [the 19-tube bundle flow straightener (1998)] is described in more detail in ISO 5167-2:2022, 6.3.2. The tube bundle flow straightener consists of a bundle of parallel and tangential tubes fixed together and held rigidly in the pipe. It is important to ensure that the various tubes are parallel to each other and to the pipe axis since, if this requirement is not met, the straightener itself might introduce swirl to the flow.

C.3 Flow conditioners

A flow conditioner is a device which, in addition to meeting the requirements of removing or significantly reducing swirl, is designed to redistribute the velocity profile to produce conditions close to those of [7.3.3](#).

Many flow conditioners either are or include a perforated plate. Several such devices are now described in technical literature and they are in general easier to manufacture, install and accommodate than the tube bundle flow straightener. They have the advantage that their thickness is typically around $D/8$ as compared to a length of at least $2D$ for the tube bundle. Moreover, since they can be drilled from the solid rather than fabricated, a more robust device is produced offering repeatable performance.

In these devices swirl is reduced and the profile simultaneously redistributed by a suitable arrangement of hole and plate depth. A number of different designs are available as indicated in ISO 5167-2:2022, 6.3.3 and Annex B. The geometry of the plate is critical in determining its performance and its pressure loss.

The Gallagher, K-Lab NOVA, NEL (Spearman), Sprengle, and Zanker flow conditioners and the Zanker flow conditioner plate are examples of flow conditioners. Information about products available commercially is given for the convenience of users of ISO 5167 and does not constitute an endorsement by ISO of these products.

C.4 Conformity testing

The tests described in 7.4.1 are required to establish that a flow conditioner:

- does not have an adverse effect in good flow conditions;
- is effective in a highly asymmetric flow;
- is effective in a highly swirling flow such as has been found downstream of a header.

The use of this test does not imply that flow measurement should be carried out downstream of a half-closed gate valve; flow control should be performed downstream of the primary device. For information regarding the work on which this test is based and the Chevron Swirler (see Figure C.1) see References [14] and [15].

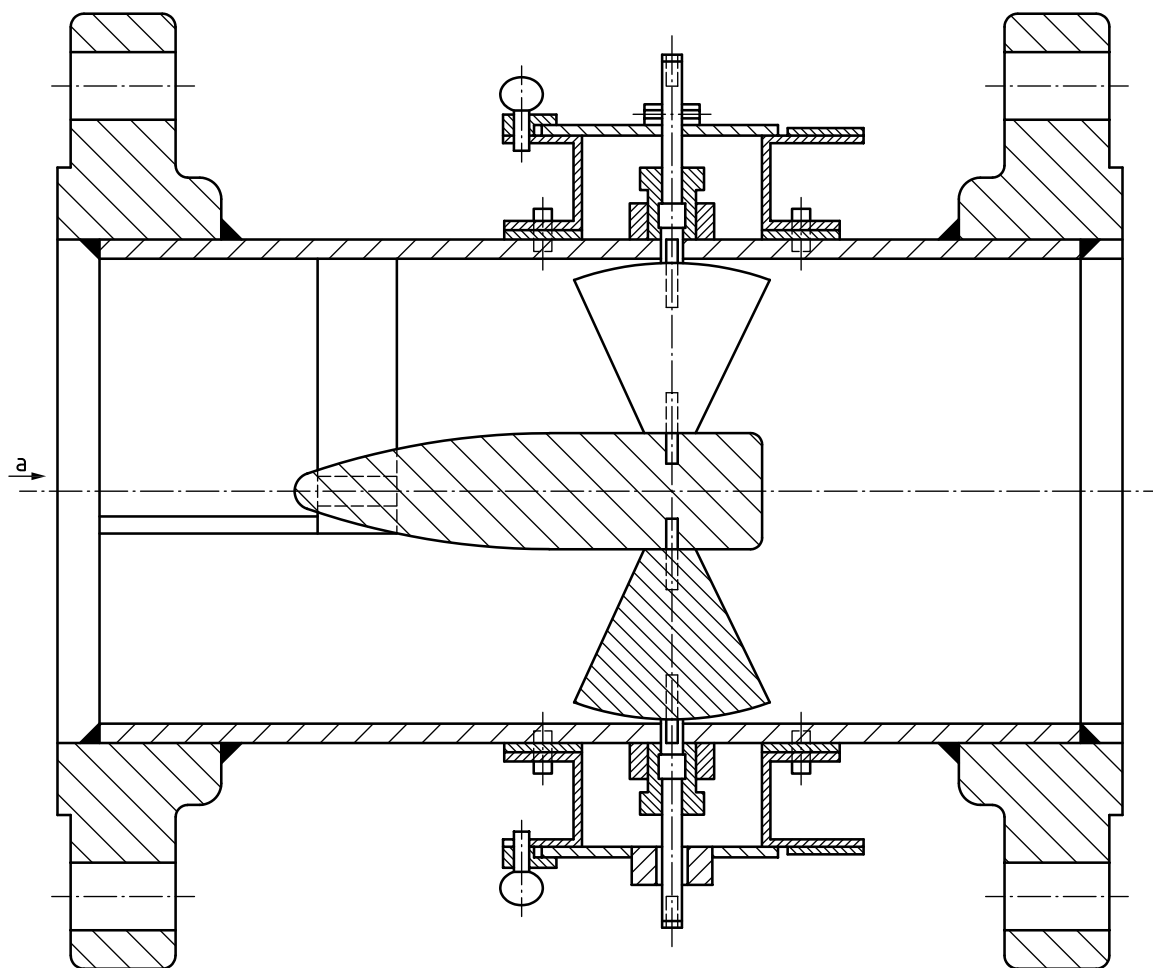

a Flow.

Figure C.1 — Chevron Swirler

Annex D (informative)

Differential pressure transmitters, flow range and turndown

D.1 Differential pressure transmitters

Early flow meters used water or mercury manometers or Bourdon gauges. Advances in the design and technology used in differential pressure transmitters have resulted in significant improvements in the flow range and uncertainty of differential pressure flow meters. Early pneumatic transmitters had limited flow range, and relatively poor flow uncertainties. These devices were largely superseded by electronic transmitters with strictly analogue circuitry producing a 4 mA to 20 mA analogue output signal. These analogue electronic transmitters have wider differential pressure ranges and lower differential pressure uncertainty than pneumatic transmitters.

Digital electronic transmitters utilize microprocessors to produce a digital signal over the entire range up to the differential pressure Upper Range Limit (URL). Digital transmitters have further extended a differential pressure meter's flow range and further decreased the flowrate prediction uncertainty. The analogue output from a digital transmitter can be provided for ranges up to the URL.

[Figure D.1](#) shows the effect of changes in DP transmitter technology on the flow range and flow uncertainty. At the conditions used in the example in [Annex E](#) a target uncertainty of $U'_{qm} = 1\%$ results in flow ranges of 2:1, 5:1, 7:1, and 11:1 for the different single DP transmitter differential pressure technologies. Note that the highest flow range was achieved by exploiting more of the features of the digital transmitter (e.g., a digital slope trim at a value less than URL which has minimal impact on the performance at values above the trim point while improving the results for lower values).



Key

X ratio of the maximum flow rate to the actual flow rate

Y mass flow rate expanded uncertainty (%)

1 U'_{q_m} using a pneumatic differential pressure transmitter (%)

2 U'_{q_m} using an analogue electronic differential pressure transmitter (%)

3 U'_{q_m} using a digital electronic differential pressure transmitter (%)

4 U'_{q_m} using a digital electronic differential pressure transmitter, with digital slope trim (%)

Figure D.1 — Effect of differential pressure technology on flow range and flow uncertainty

The ranges, accuracies and characteristics of digital electronic differential pressure transmitters vary between manufacturers; however, similar terminology is used throughout. Several performance aspects should be considered when selecting an appropriate differential pressure transmitter; common terms used are:

- URL – Upper range limit of the instrument.
- Span – the range over which the instrument has been set or calibrated.
- Reference uncertainty – often includes linearity, hysteresis and repeatability and is the basic uncertainty of the instrument.

NOTE 1 Transmitter manufacturers often refer to reference uncertainty as reference accuracy, and this is typically stated as an absolute value, e.g. percent of span.

- Static pressure effect – the effect the static pressure has on the performance of the instrument.
- Ambient temperature effect – the effect the ambient temperature has from that at which the instrument was calibrated.
- Stability – the effect of drift of the instrument calibration over a period.
- Vibration effects, mounting position effects and power supply effects - examples of additional effects that can increase the overall measurement uncertainty of the instrument.

All the performance specifications should be considered when calculating the total measurement uncertainty of the instrument. The total uncertainty for a differential pressure transmitter is typically calculated by taking the root sum of the square of each component at the same confidence interval, as shown in [Formula D.1](#):

$$U'_{\Delta p} = \sqrt{\left(U'_{\text{ReferenceUncertainty}}\right)^2 + \left(U'_{\text{StaticPressure}}\right)^2 + \left(U'_{\text{AmbientTemperature}}\right)^2 + \left(U'_{\text{Stability}}\right)^2 + \dots} \quad (\text{D.1})$$

NOTE 2 The manufacturer's specification for the differential pressure transmitter can provide guidance on the value or formula for each component given in the preceding formula, which can require one or more terms involving the differential pressure reading, URL, and Span.

Digital differential pressure transmitters often have the capability to measure multiple process parameters, as well as providing additional features such as alarms and diagnostic information.

D.2 Turndown

The flow range of a flow meter is commonly described as the “turndown”, which is the ratio of the maximum to the minimum value of a given parameter. For this document, it is assumed that this parameter is the volume flow rate of a known fluid that can be metered at a given thermodynamic flow condition within the meter's stated flow rate prediction uncertainty at the stated confidence level.

Turndown does not detail a flow meter's actual volume flow range (for instance, a 10:1 meter may be 100 m³/h to 10 m³/h, or 1 000 m³/h to 100 m³/h).

Flow meters can often continue to operate outside their turndown flow range at higher uncertainties. Flow meters may also be designed to cope with a temporary unexpected increase in flow – “surge” flow – beyond the maximum flow rating of the meter without sustaining damage and remain fully operational on return to normal flow range. It is useful if a flow meter continues to measure the flow during surge at either the stated or a higher flow uncertainty, but it is generally considered less important. A differential pressure meter's ability to cope with surge flow is dependent upon the type of meter.

Limits on maximum flow velocity (and corresponding volume flow range), such as to minimise erosion or permanent pressure loss in the system, or a minimum operational velocity, may also dictate additional practical limitations to the usable turndown of any type of meter.

D.3 Differential pressure meter flow range factors

D.3.1 General

The volume flow rate of a differential pressure meter is proportional to the square root of the primary signal differential pressure. Hence, the volume flow rate range of a differential pressure meter has an associated differential pressure range. The flow range of a differential pressure meter is set by several considerations such as meter type, structural integrity, permanent pressure loss, diameter ratio, flow conditions, and readable differential pressure range.

D.3.2 Meter type

For any given line size, diameter ratio, and flow condition range, different differential pressure meter types (i.e., orifice plates, nozzles, Venturi nozzles, Venturi tubes, cone, and wedge meters) produce a different differential pressure range. This differential pressure range dictates the flow rate range. Designers will select a suitable differential pressure range based on factors such as structural integrity of the primary element, maximum desired permanent pressure loss, and fluid conditions.

D.3.3 Diameter ratio

For a given differential pressure meter, the choice of diameter ratio dictates the differential pressure range and associated flow range.

D.3.4 Structural integrity

The maximum flow rate shall be restricted so that it does not produce an associated maximum differential pressure that can cause significant elastic or plastic deformation of the primary element.

D.3.5 Permanent pressure loss

For a given flow rate of a fluid with known physical properties the maximum flow rate produces an associated maximum differential pressure, and a corresponding maximum permanent pressure loss. Users may state a maximum permanent pressure loss, which in effect determines the maximum allowable differential pressure and associated maximum flow rate.

D.3.6 Flow conditions

Care should be taken when designing a differential pressure meter that the flow rate and associated differential pressure ranges are such that local thermodynamic conditions do not cross the flowing fluid's phase boundary (causing, e.g., cavitation in water flow, or liquid drop out of a natural gas flow).

D.3.7 Differential pressure range

The flow range of a given differential pressure meter type is dictated by the readable differential pressure instrumentation range. Therefore, a large readable differential pressure range is preferred. The turndown of any given differential pressure meter can be significantly expanded by using multiple differential pressure transmitters of different overlapping differential pressure ranges. The use of multiple differential pressure transmitters to measure the differential pressure produced across a pair of pressure ports is called 'stacking' differential pressure transmitters.

In early examples of flow metering with differential pressure meters, the differential pressure measurements were taken using water or mercury manometers, Bourdon gauges, or standalone analogue differential pressure transmitters. These methods produced a limited differential pressure measurable range with a differential pressure turndown (i.e., the ratio of maximum to minimum differential pressure reading at the stated required uncertainty and confidence level) of the order of 10:1, corresponding to a flow rate turndown of $\sqrt{10}:1$, i.e. $\approx 3:1$.

Modern differential pressure metering systems utilise digital differential pressure transmitters, either a standalone single differential pressure transmitter, or multiple differential pressure transmitters (in a 'stack') with varying ranges of overlapping differential pressures such that the overall measurable differential pressure range is that required by the specific application. Individual digital differential pressure transmitter turndown is specific to a manufacturer's design and the application, but typically significantly larger than the 10:1 from early digital technology. Differential pressure meters with stacked digital differential pressure transmitters can have turndowns greater than 20:1. [Figure D.2](#) provides an illustration of a typical metering system uncertainty example using three stacked differential pressure transmitters.

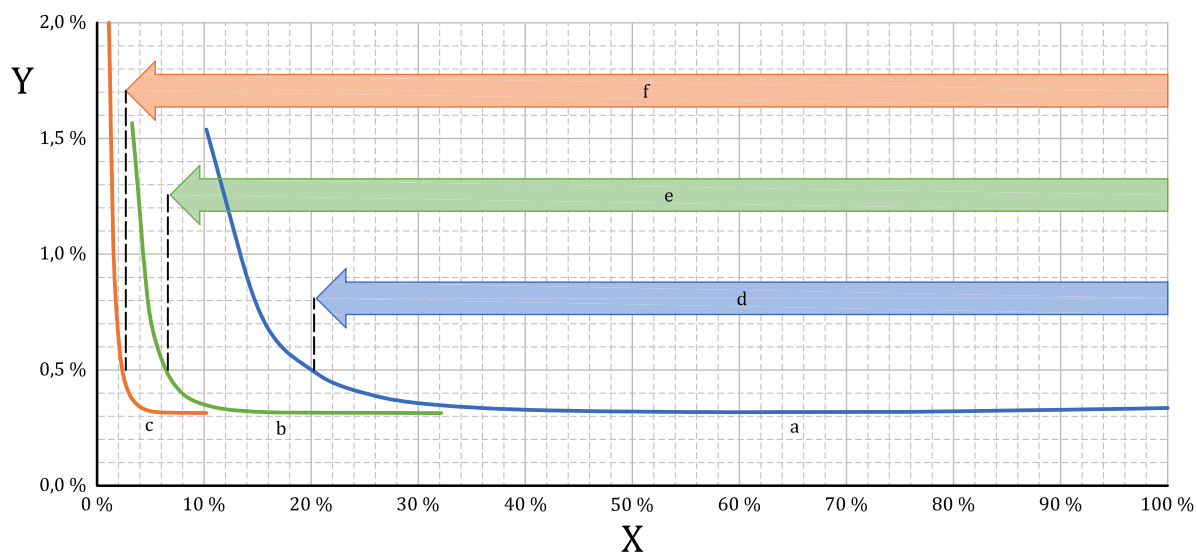

Key

- X percentage of full-scale flow rate (%)
- Y mass flow rate expanded uncertainty (%)
- a Mass flow rate expanded uncertainty using high-range DP transmitter.
- b Mass flow rate expanded uncertainty using mid-range DP transmitter.
- c Mass flow rate expanded uncertainty using low-range DP transmitter.
- d 5:1 Turndown using high-range DP transmitter only (at 0,5 % mass flow rate expanded uncertainty).
- e 16:1 Turndown using high- and mid-range DP transmitters (at 0,5 % mass flow rate expanded uncertainty).
- f 42:1 Turndown using all three DP Transmitters (at 0,5 % mass flow rate expanded uncertainty).

Figure D.2 — Illustration of mass flow rate expanded uncertainty for a stacked differential pressure transmitter system

D.3.8 Adjustable flow ranges

If process flow conditions change over time in such a way that a flow meter design no longer offers the appropriate flow range and turndown, differential pressure meters can often be re-configured so that the required new flow range and turndown are matched without the requirement to replace the entire metering system. For instance, differential pressure meters can have differential pressure transmitters re-ranged, or replaced with a differential pressure transmitter of a different range more suitable for the new flow conditions.

Some differential pressure meter designs also make possible replaceable primary elements, enabling a different diameter ratio to be readily used.

D.4 Comparing meter turndowns

In most applications the maximum flow rate to be metered is set. Hence, for any given application, the maximum flow rate is the same for all meters with different turndowns being considered. The flow meter's turndown therefore represents, for the set maximum flow rate, the minimum flow rate that can be read at the required flow uncertainty at the stated confidence level. For a set maximum flow rate, the flow range comparison of a flow meter A with a turndown of $x:1$ and a flow meter B with a turndown of $y:1$, where $x > y$, is given by [Formulae D.2](#) and [D.3](#). [Formula D.2](#) calculates the percentage of meter A's flow range that can be covered by meter B, λ (in %). [Formula D.3](#) calculates the extra absolute flow range, ψ (in %), achieved by meter A compared with meter B.

$$\lambda \% = \left[\frac{x(y-1)}{y(x-1)} \right] \times 100 \quad (\text{D.2})$$

$$\psi \% = \left[\frac{x-y}{x(y-1)} \right] \times 100 \quad (\text{D.3})$$

Flow turndown is often misinterpreted. A flow meter with a turndown of 20:1 is often assumed to have double the flow range of a flow meter with a turndown of 10:1; however, it does not.

For example, consider an application with a maximum flow relating to 30 m/s. Let meter A have a 20:1 turndown. The minimum flow would relate to 1,5 m/s (i.e. 30:1,5 = 20:1). Let meter B have a 10:1 turndown. The minimum flow would relate to 3 m/s (i.e. 30:3 = 10:1). Meter B with a 10:1 flow turndown covers $\lambda = 94,74$ % of meter A's flow range, and meter A's flow range is $\psi = 5,56$ % wider than meter B's. These values can be calculated from [Formulae D.2](#) and [D.3](#):

$$\lambda \% = \left[\frac{x(y-1)}{y(x-1)} \right] \times 100 \% = \left[\frac{20(10-1)}{10(20-1)} \right] \times 100 \% = 94,74 \%$$

$$\psi \% = \left[\frac{x-y}{x(y-1)} \right] \times 100 \% = \left[\frac{20-10}{20(10-1)} \right] \times 100 \% = 5,56 \%$$

[Figure D.3](#) shows that for a set maximum flow rate (100 % full scale) as flow turndown increases a law of diminishing returns exists. Each step increase in turndown creates a smaller increase in flow range attained.

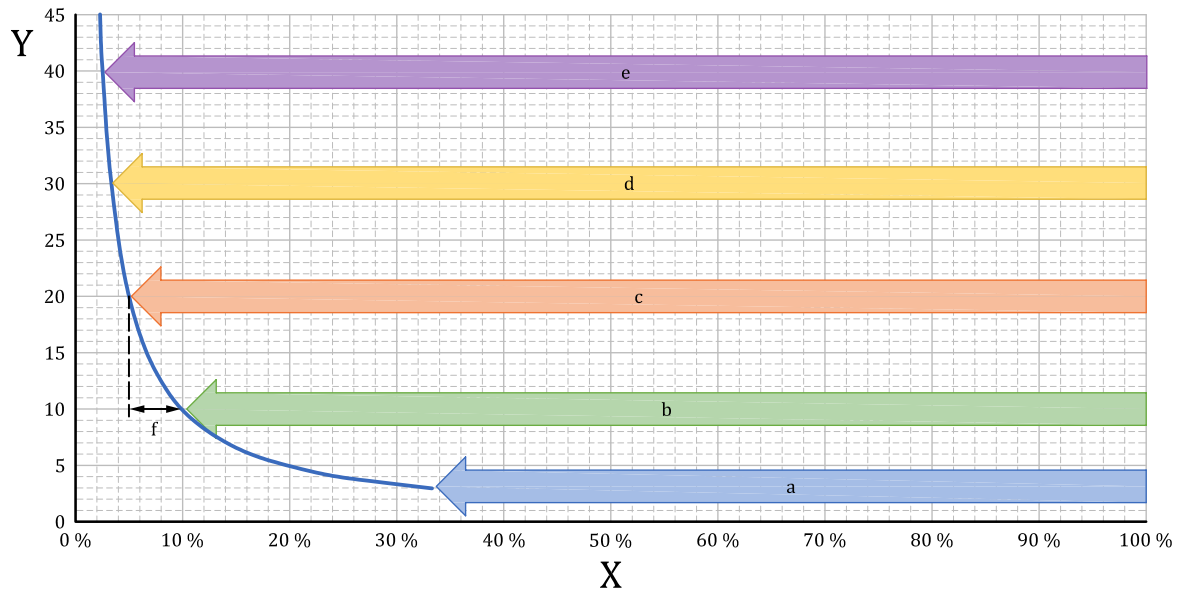

Key

- X percentage of full-scale flow rate (%)
- Y turndown
- a 3:1 turndown.
- b 10:1 turndown.
- c 20:1 turndown.
- d 30:1 turndown.
- e 40:1 turndown.
- f 5 % of full scale is 5,56 % of 10:1 turndown.

Figure D.3 — Flow rate range to turndown comparisons

Annex E (informative)

Example of uncertainty calculation for a differential pressure device

E.1 Meter setup

This example shows the calculation procedure for the mass flow uncertainty of a differential pressure metering system (at 2σ , or approximately 95 % confidence level). This requires using the practical working formula for combining uncertainties and sensitivities of each component from [8.3.2](#).

Consider an 8" schedule 80, $\beta = 0,5$ flange tapping orifice meter (as per ISO 5167-2:2022). The inlet diameter is 193,68 mm (7,625"), the orifice bore is 96,84 mm (3,813"). The flowing temperature is equal to that when the geometry measurements were taken; so thermal expansion effects are therefore negligible.

A flow of methane with a molecular mass of 16,043 g/mol has an absolute pressure and temperature of 20 bar (2,0 MPa) and 288,15 K respectively. At these conditions, the methane gas compressibility $Z = 0,961\ 3$, and therefore the gas density is calculated to be 13,93 kg/m³. Methane at this thermodynamic condition has a dynamic viscosity of $1,114\ 5 \times 10^{-5}$ Pa·s and an isentropic exponent of 1,308.

The volume flow rate is 1 000 m³/h, i.e., a gas velocity of 9,43 m/s, and a mass flow rate of 3,869 kg/s. The pipe Reynolds number is calculated as $2,282 \times 10^6$.

The orifice discharge coefficient $C = 0,602\ 6$. The differential pressure produced is 25,76 kPa.

E.2 Uncertainty and sensitivity of parameters

E.2.1 General

The calculation of the mass flow rate, as per [Formula \(1\)](#), is a function of the following parameters:

$$q_m = f(C, \varepsilon, \Delta p, d, D, \rho_1)$$

The uncertainty in each parameter is given to 2σ , or approximately 95 % confidence level, and is assumed to be normally distributed where not otherwise specified.

E.2.2 Discharge coefficient, C

The discharge coefficient for an 8" flange tap orifice meter with $\beta = 0,5$ (ISO 5167-2:2022, 5.3.2.1) has an uncertainty of $U'_C = 0,5$ %. As the mass flow rate is directly proportional to the discharge coefficient, the sensitivity to the discharge coefficient $S_C = 1,0$.

NOTE This uncertainty calculation example is for an uncalibrated primary element.

E.2.3 Expansibility, ε

The expansibility for an orifice meter (ISO 5167-2:2022, 5.3.3.2) has an uncertainty of:

$$U'_\varepsilon = 3,5 \frac{\Delta p}{\kappa p_1} = 3,5 \frac{2,576 \times 10^4}{1,308 \times 2 \times 10^6} = 0,034 \text{ 5 \%} \quad (\text{E.1})$$

As the mass flow rate is directly proportional to the expansibility, the sensitivity to the expansibility $S_\varepsilon = 1,0$.

E.2.4 Differential pressure, Δp

As the uncertainty in the differential pressure will depend upon the digital differential pressure transmitter used, a transmitter with a URL of 62,16 kPa (621,6 mbar) and an absolute uncertainty of 0,05 % URL at $k=3$ (a confidence level of approximately 99 %) was used. This results in an expanded uncertainty, $U'_{\Delta p}$, of 0,121 % at the example conditions. As the mass flow rate is proportional to the square root of the differential pressure, the sensitivity to the differential pressure $S_{\Delta p} = 0,5$.

E.2.5 Orifice diameter, d

The uncertainty of the orifice diameter should be calculated from [8.3.2.4](#).

For the sake of this example, it is assumed that the orifice diameter has an uncertainty of $U'_d = 0,05 \text{ \%}$ with a rectangular distribution.

The sensitivity to the orifice bore diameter is, as in [8.3.2.1](#),

$$S_d = \frac{2}{1 - \beta^4} = \frac{2}{1 - 0,5^4} = 2,133 \text{ 3} \quad (\text{E.2})$$

E.2.6 Upstream pipe diameter, D

The uncertainty of the pipe diameter should be calculated from [8.3.2.4](#).

For the sake of this example, it is assumed that the upstream pipe diameter has an uncertainty $U'_D = 0,25 \text{ \%}$ with a rectangular distribution.

The sensitivity to the upstream pipe diameter is, as in [8.3.2.1](#),

$$S_D = \frac{-2\beta^4}{1 - \beta^4} = \frac{-2(0,5)^4}{1 - 0,5^4} = -0,133 \text{ 3} \quad (\text{E.3})$$

E.2.7 Mass density, ρ_1

The mass density for a gas can be calculated from the pressure, p_1 , temperature, T , gas molecular mass, M , and gas compressibility, Z :

$$\rho_1 = \frac{p_1 M}{Z R_u T} \quad (\text{E.4})$$

where R_u is the gas constant. The molecular mass is known to a high precision, such that the uncertainty in it is negligible. R_u is known exactly.

As such, the uncertainty in the density can be calculated as the sum of the square of the uncertainties in each non-negligible term (all these uncertainties are assumed to have a normal distribution):

$$U'_{\rho_1} = \sqrt{U'_{p_1}{}^2 + U'_T{}^2 + U'_Z{}^2} = \sqrt{(0,2 \%)^2 + (0,34 \%)^2 + (0,1 \%)^2} = 0,406 \ 9 \ \% \quad (\text{E.5})$$

As the mass flow rate is proportional to the square root of the mass density, the sensitivity to the density is $S_{\rho_1} = 0,5$.

E.2.8 Combining the uncertainties

The combined uncertainty in the mass flow rate can be calculated (using [Formula \(9\)](#) in [8.3.2](#)) by creating an uncertainty budget table (see ISO 5168:2005, 10.2). The values for the coverage factor column can be found in ISO 5168:2005 7.3 to 7.8. For example, the normal distribution has a value of 2,0 and the rectangular distribution $\sqrt{3}$.

Table E.1 — Example differential pressure meter uncertainty budget

Parameter	Relative expanded uncertainty U'	Probability distribution	Coverage Factor k	Relative standard uncertainty $u' = U'/k$	Sensitivity coefficient S	Contribution to overall uncertainty $u' \times S$
Discharge coefficient, C	0,50 %	Normal	2	0,250 0 %	1,0	0,250 0 %
Expansibility, ϵ	0,034 5 %	Normal	2	0,017 2 %	1,0	0,017 2 %
Differential pressure, Δp	0,121 %	Normal	3	0,040 2 %	0,5	0,020 1 %
Orifice bore diameter, d	0,05 %	Rectangular	$\sqrt{3}$	0,028 9 %	2,133 3	0,061 6 %
Orifice inlet diameter, D	0,25 %	Rectangular	$\sqrt{3}$	0,144 3 %	-0,133 3	-0,019 2 %
Mass density, ρ_1	0,406 9 %	Normal	2	0,203 5 %	0,5	0,101 7 %
Combined uncertainty	-	-	-	-	-	0,278 8 %
Expanded uncertainty	0,557 5 %	Normal	2	-	-	-

The relative standard uncertainty for each parameter is the relative expanded uncertainty divided by the coverage factor, and is equivalent to the one standard deviation uncertainty for each term. The contribution to the overall relative standard uncertainty is then the relative standard uncertainty times the sensitivity coefficient.

The combined relative standard uncertainty is the sum of the squares of the individual contributions to the overall relative standard uncertainty. The relative expanded uncertainty is the combined relative standard uncertainty times the coverage factor (which on the basis of a normal distribution has a value of 2,0).

Therefore, the relative expanded uncertainty of the gas mass flow rate for this orifice metering system example is 0,557 % at $k = 2$ (approximately 95 % confidence level).

Note that if this meter was calibrated (so that the expanded uncertainty in C was determined as 0,2 % from a calibration facility for this example), then the relative expanded uncertainty would be calculated to be 0,318 %.

As stated in [E.2.4](#) differential pressure uncertainty varies with the differential pressure. Given this, the contributions of the six terms in [Table E.1](#) to U'_{q_m} will vary with the differential pressure. [Figure E.1](#)

shows how the relative contributions to U'_{q_m} of the six parameters identified in the example uncertainty calculation change when the differential pressure varies from 100 % to 1 % of the URL (100 % flow to 10 % flow). In this example the differential pressure is varied with other parameters fixed. It is seen that at high flow rates (high differential pressure) U'_C is the major contributor. As the flow rate is reduced $U'_{\Delta p}$ increases until it eventually becomes the major contributor.

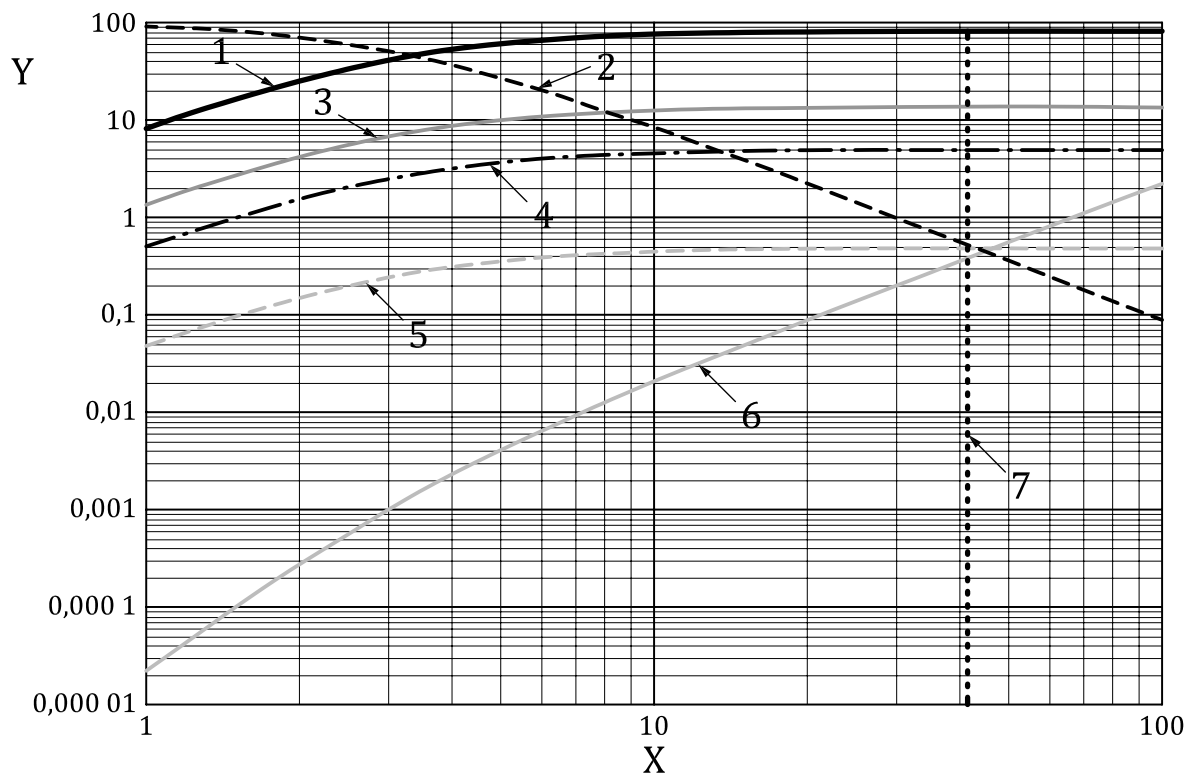

Key

- X percentage of full-scale differential pressure
- Y contribution to mass flow rate uncertainty (%)
- 1 discharge coefficient uncertainty contribution
- 2 differential pressure uncertainty contribution
- 3 density uncertainty contribution
- 4 orifice diameter uncertainty contribution
- 5 pipe diameter uncertainty contribution
- 6 expansibility (expansion factor) uncertainty contribution
- 7 example conditions

Figure E.1 — Percentage contribution to mass flow rate uncertainty as flow rate varies

Annex F (informative)

Permanent pressure loss example

The alternative differential pressure meter designs (and their key characteristics, particularly β) specified in each part of ISO 5167 can have significantly different permanent pressure loss characteristics.

As stated in 5.6.3, the permanent pressure loss of a differential pressure meter, $\Delta\varpi$, is the pressure loss caused by its insertion into a piping installation. Typically, it is assumed that the pressure is measured from a tapping D upstream of the metering system to a second tapping $6D$ downstream of the metering system.

The pressure loss coefficient of a differential pressure meter, K , is defined as:

$$K = \frac{\Delta\varpi}{\frac{1}{2}\rho_1 V^2} \quad (\text{F.1})$$

Therefore, the pressure loss at a set of conditions can be calculated as:

$$\Delta\varpi = \frac{1}{2}\rho_1 V^2 K \quad (\text{F.2})$$

As a flow meter is an integral part of a piping installation, considering the permanent pressure loss of a stand-alone meter is an abstract exercise. The following example places a flow meter's permanent pressure loss in the context of a piping installation's overall permanent pressure loss. Overall lengths of piping installations vary drastically between industries and applications, and therefore the choice of pipe length for this example is arbitrary.

Consider a 304 800 mm (1 000-foot) length of 8" schedule 80 pipe ($D = 193,675$ mm) with a typical pipe friction factor of 0,014. The pressure loss coefficient of this piping installation (typically known as the "major" pipe loss coefficient, K_{major}) can be calculated as:

$$K_{\text{major}} = \lambda \frac{L}{D} = 0,014 \frac{304\,800}{193,675} = 22,03 \quad (\text{F.3})$$

In addition, assume that there are several additional "minor" losses in the piping installation due to other pipe components:

- Globe valve fully open, $K_{\text{minor}} = 4,76$
- Four standard 90° bends, each with $K_{\text{minor}} = 0,42$
- A tee, $K_{\text{minor}} = 0,28$
- A sample probe, $K_{\text{minor}} = 0,09$
- Two thermowells, each with $K_{\text{minor}} = 0,09$

NOTE The major and "minor" losses for the globe valve, standard bends, and tee used in this example are typical values from Reference [16].

Summing these minor pressure loss component coefficients gives $K_{\text{minor}} = 6,99$.

Flow conditioners may also be used as part of some metering systems, most commonly in industry with orifice plates and nozzles. A typical flow conditioner (e.g. NOVA's design of K-Lab perforated plate flow conditioner, as per ISO 5167-2:2022, B.3.2) can have $K = 2$.

The flow meter pressure loss coefficient for this example is given for each meter specified in the other parts of ISO 5167 (orifice plate, ISA nozzle, Venturi tube with the highest loss 15° divergent section, cone meter and wedge meter), calculated separately for $\beta = 0,5$ and $\beta = 0,7$.

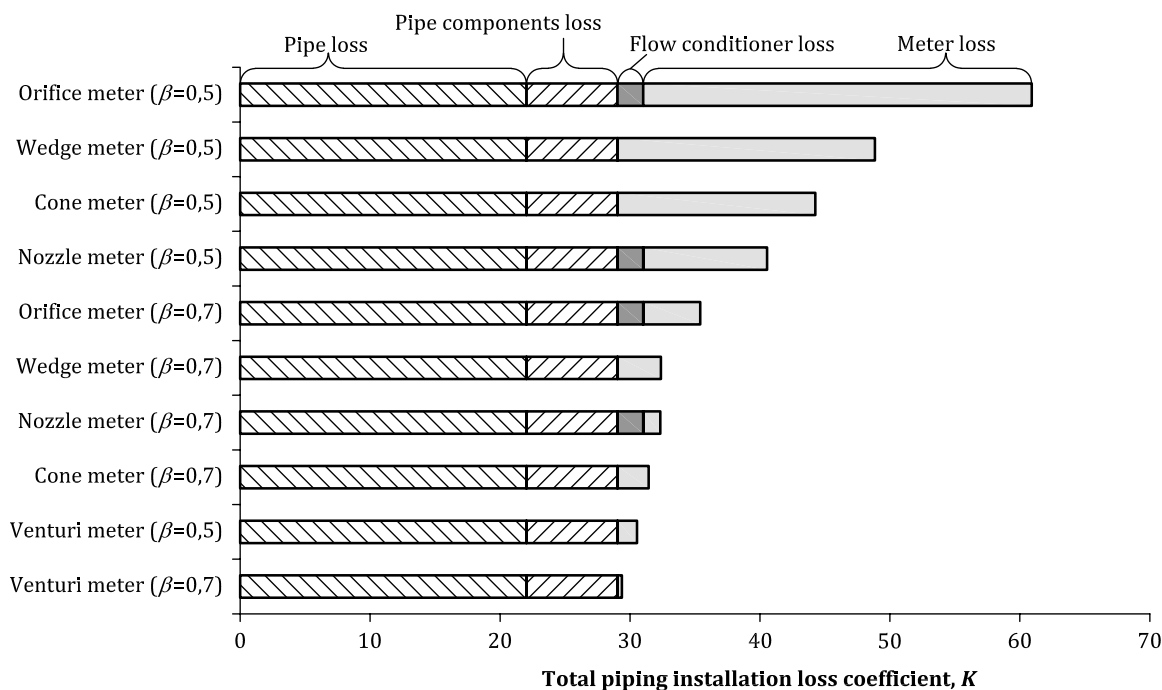

Figure F.1 — Example comparison of total piping installation pressure loss coefficient for differential pressure metering system alternatives

[Figure F.1](#) provides a graphical illustration of the total loss coefficient for the piping installation: the pipe itself, pipe components, flow conditioner (if applicable) and differential pressure meter. This demonstrates that the permanent pressure loss associated with a differential pressure meter might or might not be a significant component of the overall pressure loss of the whole piping installation.

It is also clear that the Venturi meter – even with the largest allowable divergent cone angle, and therefore the greatest permanent pressure loss – has by far the smallest overall pressure loss. The impact of the flow meter β is also significant for all meter types.

Bibliography

- [1] ISO 2186, *Fluid flow in closed conduits — Connections for pressure signal transmissions between primary and secondary elements*
- [2] ISO/TR 3313, *Measurement of fluid flow in closed conduits — Guidelines on the effects of flow pulsations on flow-measurement instruments*
- [3] ISO/TR 9464:2008, *Guidelines for the use of ISO 5167:2003*
- [4] ISO/TR 12767, *Measurement of fluid flow by means of pressure differential devices — Guidelines on the effect of departure from the specifications and operating conditions given in ISO 5167*
- [5] ISO/TR 15377, *Measurement of fluid flow by means of pressure-differential devices — Guidelines for the specification of orifice plates, nozzles and Venturi tubes beyond the scope of ISO 5167*
- [6] ISO 21920-3, *Geometrical product specification (GPS) — Surface texture: Profile — Specification operators*
- [7] ISO 80000-2, *Quantities and units — Part 2: Mathematics*
- [8] NIAZI A., THALAYASINGAM S. Temperature changes across orifice meters. In *Proc. of 19th North Sea Flow Measurement Workshop*, Norway, Paper 13, October 2001
- [9] SCHLICHTING H., *Boundary layer theory*. New York, McGraw-Hill, 1960
- [10] STUDZINSKI W., BOWEN J. White Paper on *Dynamic Effects on Orifice Measurement*, Washington D.C., American Petroleum Institute, 1997
- [11] READER-HARRIS M.J. Pipe roughness and Reynolds number limits for the orifice plate discharge coefficient equation. In *Proc. of 2nd Int. Symp. on Fluid Flow Measurement*, Calgary, Canada, Arlington, Virginia: American Gas Association, June 1990, pp. 29-43
- [12] READER-HARRIS M.J., SATTARY J.A., SPEARMAN E. P. *The orifice plate discharge coefficient equation*. Progress Report No PR14: EUEC/17 (EEC005). East Kilbride, Glasgow: National Engineering Laboratory Executive Agency, May 1992
- [13] READER-HARRIS M. J., *Orifice plates and Venturi tubes*. Springer, 2015
- [14] STUDZINSKI W., KARNIK U., LANASA P., MORROW T., GOODSON D., HUSAIN Z. et al. White Paper on *Orifice Meter Installation Configurations with and without Flow Conditioners*, Washington D.C., American Petroleum Institute, 1997
- [15] SHEN J.J.S., *Characterization of Swirling Flow and its Effects on Orifice Metering*. SPE 22865. Richardson, Texas: Society of Petroleum Engineers, 1991
- [16] CRANE CO, "Flow of Fluids through Valves, Fittings and Pipe – Technical Paper No.410", Crane, 2018
- [17] STEVEN R., BRITTON C., KINNEY J. Differential Pressure Meters—A Cabinet of Curiosities (and Some Alternative Views on Accepted DP Meter Axioms). In *Proc. of 30th International North Sea Flow Measurement Workshop 2012*, UK, Paper 5.1, October 2001

[\(Continued from second cover\)](#)

<i>International Standard</i>	<i>Corresponding Indian Standard</i>	<i>Degree of Equivalence</i>
ISO 5168 : 2005 Measurement of fluid flow — Procedures for the evaluation of uncertainties	IS 17288 : 2021 Measurement of Fluid flow — Procedures for evaluation of uncertainties	Identical

The Committee responsible for the preparation of this standard has reviewed the provisions of the following ISO/IEC standard and has decided that they are acceptable for use in conjunction with this standard:

<i>International Standard</i>	<i>Title</i>
ISO 4006 : 1991	Measurement of fluid flow in closed conduits — Vocabulary and symbols
ISO/IEC Guide 98-3	Uncertainty of measurement — Part 3: Guide to the expression of uncertainty in measurement (GUM : 1995)

For the purpose of determining whether a particular requirement of this standard is complied with the final value, observed or calculated expressing the result of a test or analysis shall be rounded off in accordance with IS 2 : 2022 'Rules for rounding off numerical values (*second revision*)'. The number of significant places retained in the rounded off value should be the same as that of the specified value in this standard.

Bureau of Indian Standards

BIS is a statutory institution established under the *Bureau of Indian Standards Act, 2016* to promote harmonious development of the activities of standardization, marking and quality certification of goods and attending to connected matters in the country.

Copyright

BIS has the copyright of all its publications. No part of these publications may be reproduced in any form without the prior permission in writing of BIS. This does not preclude the free use, in the course of implementing the standard, of necessary details, such as symbols and sizes, type or grade designations. Enquiries relating to copyright be addressed to the Head (Publication & Sales), BIS.

Review of Indian Standards

Amendments are issued to standards as the need arises on the basis of comments. Standards are also reviewed periodically; a standard along with amendments is reaffirmed when such review indicates that no changes are needed; if the review indicates that changes are needed, it is taken up for revision. Users of Indian Standards should ascertain that they are in possession of the latest amendments or edition by referring to the website-www.bis.gov.in or www.standardsbis.in.

This Indian Standard has been developed from Doc No.: WRD 01 (22063).

Amendments Issued Since Publication

Amend No.	Date of Issue	Text Affected

BUREAU OF INDIAN STANDARDS

Headquarters:

Manak Bhavan, 9 Bahadur Shah Zafar Marg, New Delhi 110002

Telephones: 2323 0131, 2323 3375, 2323 9402

Website: www.bis.gov.in

Regional Offices:

Central : 601/A, Konnectus Tower -1, 6th Floor,
DMRC Building, Bhavbhuti Marg, New
Delhi 110002

Telephones

{ 2323 7617

Eastern : 8th Floor, Plot No 7/7 & 7/8, CP Block, Sector V,
Salt Lake, Kolkata, West Bengal 700091

{ 2367 0012
{ 2320 9474

Northern : Plot No. 4-A, Sector 27-B, Madhya Marg,
Chandigarh 160019

{ 265 9930

Southern : C.I.T. Campus, IV Cross Road, Taramani, Chennai 600113

{ 2254 1442
{ 2254 1216

Western : 5th Floor/MTNL CETTM, Technology Street, Hiranandani Gardens,
Powai, Mumbai 400076

{ 2570 0030
{ 2570 2715

Branches : AHMEDABAD, BENGALURU, BHOPAL, BHUBANESHWAR, CHANDIGARH, CHENNAI, COIMBATORE, DEHRADUN, DELHI, FARIDABAD, GHAZIABAD, GUWAHATI, HARYANA (CHANDIGARH), HUBLI, HYDERABAD, JAIPUR, JAMMU, JAMSHEDPUR, KOCHI, KOLKATA, LUCKNOW, MADURAI, MUMBAI, NAGPUR, NOIDA, PARWANOO, PATNA, PUNE, RAIPUR, RAJKOT, SURAT, VIJAYAWADA.