

FIG. 28

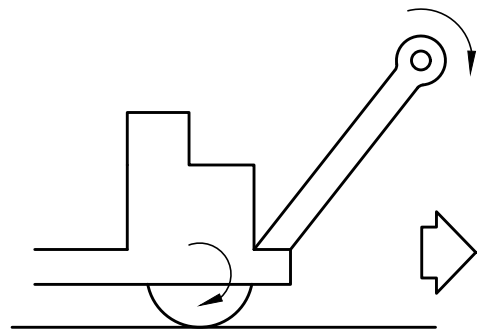

FIG. 29A