

प्रक्रिया प्रवाह आरेख, पाइपिंग और
मापयन्त्रण आरेख हेतु आलेखीय प्रतीकों पर
अनुशंसा

(तीसरा पुनरीक्षण)

Recommendations on Graphical
Symbols for Process Flow Diagrams,
Piping and Instrumentation
Diagrams

(Third Revision)

ICS 01.080.30; 23.040.01

© BIS 2024



भारतीय मानक ब्यूरो
BUREAU OF INDIAN STANDARDS
मानक भवन, 9 बहादुर शाह ज़फर मार्ग, नई दिल्ली - 110002
MANAK BHAVAN, 9 BAHADUR SHAH ZAFAR MARG
NEW DELHI - 110002
www.bis.gov.in www.standardsbis.in

FOREWORD

This Indian Standard (Third Revision) was adopted by the Bureau of Indian Standards, after the draft finalized by the Chemical Engineering Plants and Related Equipment Sectional Committee had been approved by the Mechanical Engineering Divisional Council.

Process flow diagrams are widely used in chemical industry as an aid to show basic items of major equipments and their relations to one another in the process scheme. The important flow lines are indicated as connecting items of equipments and help to describe how the process operates.

Piping and instrumentation diagrams are used in the chemical industry to indicate all important aspects such as:

- a) All equipment items;
- b) All instrument items;
- c) All pipelines; and
- d) Important aspects such as insulations, slopes, equipment elevations, etc.

This standard was first published in 1965 and then revised in 1976 and 1999. The present revision has been taken up with a view to incorporate the modification found necessary as a result of experience gained in the use of this standard. Also, in this revision, the standard has been brought into the latest style and format of Indian Standards, and references to Indian Standards, wherever applicable have been updated. In this revision, the following major changes have been made.

The composition of the Committee responsible for the formulation of this standard is given in [Annex A](#).

For the purpose of deciding whether a particular requirement of this standard is complied with the final value, observed or calculated, expressing the result of a test or analysis, shall be rounded off in accordance with IS 2 : 2022 'Rules for rounding off numerical values (*second revision*)'. The number of significant places retained in the rounded off value should be the same as that of the specified value in this standard.

Indian Standard

RECOMMENDATIONS ON GRAPHICAL SYMBOLS FOR PROCESS FLOW DIAGRAMS, PIPING AND INSTRUMENTATION DIAGRAMS

*(Third Revision)***1 SCOPE**

This standard lays down symbols that are to be used while preparing process flow diagrams as well as piping and instrumentation diagrams in order to represent the major requirements of plant or units in the chemical industry.

2 SYMBOLS

2.1 The symbols indicated here represent only major items of plants. Two or more of the basic symbols may be combined to represent composite units.

2.2 Requirement of symbols has been covered in the following Sections:

Section 01 General

Section 02 Process quantities

Section 03 Piping

Section 04 Valves

Section 05 Fittings

Section 06 Instruments

Section 07 Pumps

Section 08 Compressors

Section 09 Heating and cooling arrangements

Section 10 Furnaces and boilers

Section 11 Process vessels

Section 12 Storage vessels/tanks

Section 13 Dryer

Section 14 Size reduction equipment

Section 15 Separators

Section 16 Filters

Section 17 Centrifuges

Section 18 Stirrers

Section 19 Mixers

Section 20 Feeders

Section 21 Conveyors

Section 22 Transport vehicle

Section 23 Miscellaneous

Section 24 Service fluid codes

Section 25 Insulation/tracings types

SECTION 01 GENERAL

Sl No.	Symbol No.	Description	Symbols	Remarks
(1)	(2)	(3)	(4)	(5)
i)	0101	Insulation or Tracing	<p>EXAMPLES— 1) INSULATION OF A PIPELINE 2) INSULATION OF AN EQUIPMENT</p>	<p>Insulation or tracing for equipment and lines are generally not shown symbolically in PFD'S and P & ID'S.</p> <p>In P&ID'S, the letters indicating the type of insulation or tracing are placed on top of the line with or without line number.</p>

SECTION 02 PROCESS QUANTITIES

Sl No.	Symbol No.	Description	Symbols	Remarks
(1)	(2)	(3)	(4)	(5)
i)	0201	Liquid flow		Place numerical quantities specified within the symbol
ii)	0202	Gas flow		
iii)	0203	Pressure and temperature		

SECTION 03 PIPING

Sl No.	Symbol No.	Description	Symbols	Remarks
(1)	(2)	(3)	(4)	(5)
i)	0301	Inflow line		Identify by name
ii)	0302	Outflow line		Identify by name
iii)	0303	Connecting line		—
iv)	0304	Cross over line		—
v)	0305	Direction of process flow		—
vi)	0306	Slope of a process line		Indicates direction but not limits. Degrees are to be shown separately

Table (Concluded)

<i>Sl No.</i>	<i>Symbol No.</i>	<i>Description</i>	<i>Symbols</i>	<i>Remarks</i>
(1)	(2)	(3)	(4)	(5)
vii)	0307	Dead end		—
viii)	0308	Buried line		—
ix)	0309	Vendor limit line		—
x)	0310	Tracing		Form of heating to be indicated by initial letter
xi)	0311	Change of pipe specification		—
xii)	0312	Centre line		—
xiii)	0313	Coil		—
xiv)	0314	Process line		—
xv)	0315	Jacketed line		—









SECTION 04 VALVE

<i>Sl No.</i>	<i>Symbol No.</i>	<i>Description</i>	<i>Symbols</i>	<i>Remarks</i>
(1)	(2)	(3)	(4)	(5)
i)	0401	Gate valve		—
ii)	0402	Globe valve		—
iii)	0403	Check valve		—
iv)	0404	Angle valve		—
v)	0405	Diaphragm valve		—
vi)	0406	Safety valve (pressure relief valve)		—
vii)	0407	Ball valve		—

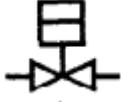
Table (Continued)

Sl No.	Symbol No.	Description	Symbols	Remarks
(1)	(2)	(3)	(4)	(5)
viii)	0408	Solenoid valve	<p>TWO WAY</p> <p>THREE WAY</p>	—
ix)	0409	Float valve		—
x)	0410	Butterfly valve		—
xi)	0411	Regulating globe valve		—
xii)	0412	Foot valve with strainer		—
xiii)	0413	Plug valve		—
xiv)	0414	Control valve		—
xv)	0415	Piston operated hydraulic control valve		—
xvi)	0416	Electrically operated control valve		—
xvii)	0417	Pinch valve		—
xviii)	0418	Spring loaded valve		—
xix)	0419	Control valve with hand wheel		—
xx)	0420	PCV down stream		—

Table (Concluded)

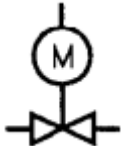
<i>Sl No.</i>	<i>Symbol No.</i>	<i>Description</i>	<i>Symbols</i>	<i>Remarks</i>
(1)	(2)	(3)	(4)	(5)
xxi)	0421	PCV up stream		—
xxii)	0422	Hand-operated valve		—
xxiii)	0423	Plunger-operated valve		—
xxiv)	0424	Pilot-operated valve		—
xxv)	0425	4-way valve		—
xxvi)	0426	Needle valve		—
xxvii)	0427	Positive choke		—
xxviii)	0428	Adjustable choke		—
xxix)	0429	Motor operated valve		—

SECTION 05 FITTINGS



<i>Sl No.</i>	<i>Symbol No.</i>	<i>Description</i>	<i>Symbols</i>	<i>Remarks</i>
(1)	(2)	(3)	(4)	(5)
i)	0501	Expansion joint		—
ii)	0502	Hose connector		—
iii)	0503	Flexible hose		—

Table (Continued)





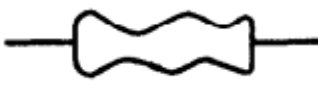
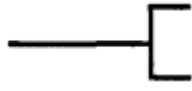





Sl No.	Symbol No.	Description	Symbols	Remarks
(1)	(2)	(3)	(4)	(5)
iv)	0504	Spectacle blind		—
v)	0505	Line blind		—
vi)	0506	Reducer/Expander		—
vii)	0507	Blind flange		—
viii)	0508	Drain funnel		—
ix)	0509	Threaded cap		—
x)	0510	Orifice		—
xi)	0511	Venturi meter		—
xii)	0512	Steam trap		—
xiii)	0513	Vent with goose neck		—
xiv)	0514	Sight glass		—
xv)	0515	Union		—
xvi)	0516	Coupling		—
xvii)	0517	Adaptor		—
xviii)	0518	Flow-element		—

Table (Continued)

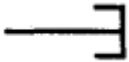
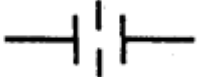

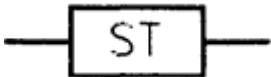

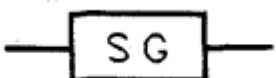
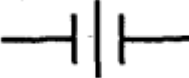
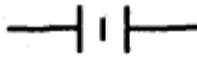

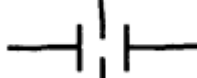



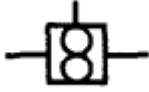
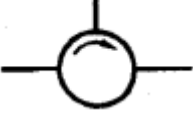
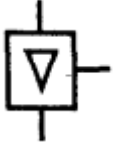

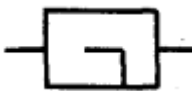
<i>Sl No.</i>	<i>Symbol No.</i>	<i>Description</i>	<i>Symbols</i>	<i>Remarks</i>
(1)	(2)	(3)	(4)	(5)
xix)	0519	Turbine meter		—
xx)	0520	Pos. disp. meter		—
xxi)	0521	Rotameter		—
xxii)	0522	Sonic meter		—
xxiii)	0523	Magnetic meter		—
xxiv)	0524	Pitot tube		—
xxv)	0525	Drain plugged		—
xxvi)	0526	Drain flanged		—
xxvii)	0527	Straightening vanes		—
xxviii)	0528	Analyser		—
xxix)	0529	Filter		—
xxx)	0530	Filter		—
xxxi)	0531	T-type strainer		—

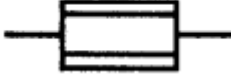
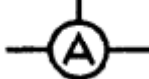
Table (Concluded)

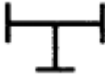
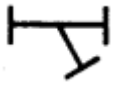
<i>Sl No.</i>	<i>Symbol No.</i>	<i>Description</i>	<i>Symbols</i>	<i>Remarks</i>
(1)	(2)	(3)	(4)	(5)
xxxii)	0532	Y-type strainer		—
xxxiii)	0533	Temporary		—
xxxiv)	0534	Basket strainer		—
xxxv)	0535	Flame arrester		—
xxxvi)	0536	Cone type strainer		—
xxxvii)	0537	Sample point		—
xxxviii)	0538	Pipe cap welded		—

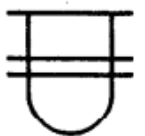
SECTION 06 INSTRUMENTS

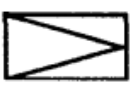
INSTRUMENTATION SYMBOL

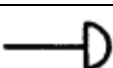



<i>Sl No.</i>	<i>Symbol No.</i>	<i>Description</i>	<i>Symbols</i>	<i>Remarks</i>
(1)	(2)	(3)	(4)	(5)
i)	0601	Instrument air signal		—
ii)	0602	Instrument electric signal		—
iii)	0603	Instrument supply lines		—
iv)	0604	Instrument capillary tubing		—
v)	0605	Hydraulic lines		—
vi)	0606	Software connections		—
vii)	0607	Locally mounted instruments		—

Table (Continued)



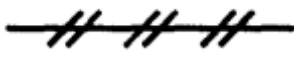

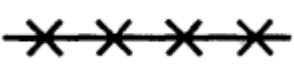
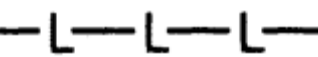
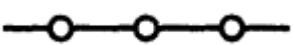















Sl No.	Symbol No.	Description	Symbols	Remarks
(1)	(2)	(3)	(4)	(5)
viii)	0608	Instrument mounted on main panel		—
ix)	0609	Instrument mounted on local panel		—
x)	0610	Transmitter locally mounted		—
xi)	0611	Transmitter panel mounted		—
xii)	0612	Computer		—
xiii)	0613	Computer local panel		—
xiv)	0614	DCS/DIDC		—
xv)	0615	Gas filter		—
xvi)	0616	Interlock		—
xvii)	0617	Rear panel instrument		—
xviii)	0618	Running light (local)		—
xix)	0619	Running light (panel)		—
xx)	0620	Running light (local panel)		—

Table (Concluded)

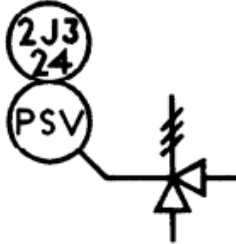
Sl No.	Symbol No.	Description	Symbols	Remarks
(1)	(2)	(3)	(4)	(5)
xxi)	0621	Remote telemetric unit		—
xxii)	0622	Inlet size		—
xxiii)	0623	Rupture disk		—
xxiv)	0624	Rotameter		—
xxv)	0625	Diaphragm seal		—
xxvi)	0626	Breather valve		—
xxvii)	0627	Programmable logic control		—
xxviii)	0628	Programmable logic control on local panel		—

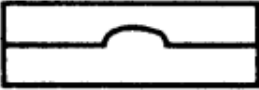
INSTRUMENT LEGEND

(See Table 1 for definition of identification letters)

Sl No.	Symbol	Definition
(1)	(2)	(3)
i)	P	Pressure instruments
ii)	T	Temperature instruments
iii)	L	Level instruments
iv)	IL	Interface level instruments
v)	F	Flow instruments
vi)	A	Analyser instruments
vii)	PCV	Self-actuated pressure control valve
viii)	TW	Thermowell

Table (Continued)

<i>Sl No.</i>	<i>Symbol</i>	<i>Definition</i>
(1)	(2)	(3)
ix)	TE	Temperature element
x)	PB	Push button
xi)	SOV	Solenoid operated valve
xii)	TJI	Multipoint indicator
xiii)	DPG	Differential pressure gauge
xiv)	DIC	Differential indicating controller
xv)	DRC	Differential recording controller
xvi)	I	Indicator
xvii)	R	Recorder
xviii)	IC	Indicating controller
xix)	RC	Recording controller
xx)	Y	Function (modifier)
xxi)	Q	Integrator (summator)
xxii)	AL	Alarm low
xxiii)	AH	Alarm high
xxiv)	ALL	Alarm low
xxv)	AHH	Alarm high
xxvi)	SL	Switch low
xxvii)	SH	Switch high
xxviii)	SLL	Switch low
xxix)	SHH	Switch high
xxx)	PI	Pressure indicator
xxxi)	TI	Temperature indicator
xxxii)	LI	Level indicator
xxxiii)	ILG	Interface level gauge
xxxiv)	FE	Flow element
xxxv)	AE	Analyser element
xxxvi)	PT	Pressure transmitter
xxxvii)	LT	Level transmitter
xxxviii)	FT	Flow transmitter
xxxix)	AT	Analyser transmitter
xl)	ILT	Interface level transmitter
xli)	PV	Pressure control valve
xlii)	TV	Temperature control valve
xliii)	LV	Level control valve
xliv)	ILV	Interface level control valve
xlv)	FV	Flow control valve
xlvi)	AV	Gas actuated valve
xlvii)	I/P	Current to pneumatic transducer
xlviii)	P/I	Pneumatic to current transducer
xlix)	I/E	Current to volts transducer
l)	E/I	Volts to current transducer

Table (Concluded)

<i>Sl No.</i>	<i>Symbol</i>	<i>Definition</i>
(1)	(2)	(3)
li)	E/P	Volts to pneumatic transducer
lii)	P/E	Pneumatic to volts transducer
liii)	SDV	Shut down valve
liv)	MOV	Motor operated valve
lv)	XL	Running light
lvi)	XI	Running indications
lvii)	TT	Temperature transmitter
lviii)	SC	Sample cooler
lix)	UC	Utility connection
lx)	FG	Flow class
lxi)	PSV	Pressure safety valve
lxii)	TSV	Thermal safety valve
lxiii)	RD	Rupture disk
lxiv)	HIC	Hand indicating controller
lxv)	HCV	Hand control valve
lxvi)	SS	Selection switch
lxvii)	FO	Control valve fail open
lxviii)	FC	Control valve fail close
lxix)	FL	Control valve fall lock
lxx)	TSO	Tight shut off
lxxi)	PVRV	Breather valve (pressure vacuum relief valve)
lxxii)	AF	Flame arrestor
lxxiii)	EX	Excess flow check valve
lxxiv)	RTU	Remote terminal unit
lxxv)	IJ	Insulation joint
lxxvi)	LSS	Low signal selector
lxxvii)	MSS	Manual signal selector
lxxviii)	LO	Lock open
lxxix)	LC	Lock close
lxxx)	ZSH	Position switch high (valve open)
lxxxi)	ZHH	Position high (valve open)
lxxxii)	ZAH	Position alarm high (valve open)
lxxxiii)	ZSL	Position switch low (valve close)
lxxxiv)	ZLL	Position low (full closed valve)
lxxxv)	ZAL	Position alarm low (valve closed)
lxxxvi)	FB	Full bore
lxxxvii)	NB	Normal bore
lxxxviii)	AS	Automatic sampler
lxxxix)	DPT	Differential pressure transmitter
xc)	FO	Restriction orifice
xci)	C	Controller
xcii)	UV	On-Off valve

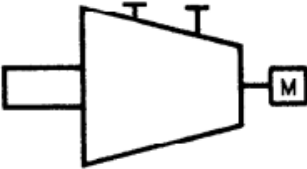
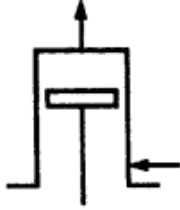
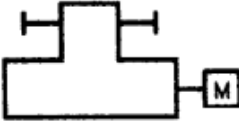
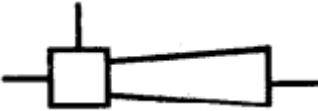

Table 1 Identification Letters*(Clause 2.2, section 6)*

SI No.	Symbol	First Letter		Succeeding Letter		
		Measured or Initiating Variables	Modifier	Read out or Passive Function	Output Function	Modifier
(1)	(2)	(3)	(4)	(5)	(6)	(7)
i)	A	Analysis	—	Alarm	—	—
ii)	B	Burner, combustion	—	User's choice	User's choice	User's choice
iii)	C	User's choice	—	—	Control	—
iv)	D	User's choice	Differential	—	—	—
v)	E	Voltage	—	Sensor (primary element)	—	—
vi)	F	Flow rate	Ratio (fraction)	—	—	—
vii)	G	User's choice	—	Glass, viewing device	—	—
viii)	H	Hand	—	—	—	High
ix)	I	Current (electrical)	—	Indicate	—	—
x)	J	Power	Scan	—	—	—
xi)	K	Time, time schedule	Time rate change	—	Control station	—
xii)	L	Level	—	Light	—	Low
xiii)	M	User's choice	Momentary	—	—	Middle intermediate
xiv)	N	User's choice	—	User's choice	User's choice	User's choice
xv)	O	User's choice	—	Office, restriction	—	—
xvi)	P	Pressure, vacuum	—	Point (test) connection	—	—
xvii)	Q	Quantity	Integrate, totalise	—	—	—
xviii)	R	Radiation	—	Record	—	—
xix)	S	Speed, frequency	Safety	—	Switch	—
xx)	T	Temperature	—	—	Transmit	—
xxi)	U	Multivariable	—	Multifunction	Multifunction	Multifunction
xxii)	V	Vibration mechanical analysis	—	—	Valve, damper, louver	—
xxiii)	W	Weight, force	—	Well	—	—
xxiv)	X	Unclassified	X-axis	Unclassified	Unclassified	Unclassified
xxv)	Y	Event, state or pressure	Y-axis	—	Relay, compute, convert	—
xxvi)	Z	Position, dimension	Z-axis	—	Driver, actuator unclassified final control element	—

SECTION 07 PUMPS

Sl No.	Symbol No.	Description	Symbols	Remarks
(1)	(2)	(3)	(4)	(5)
i)	0701	Centrifugal pumps	<p>PFD SYMBOL</p> <p>P&ID SYMBOL</p>	<p>GEAR PUMP</p>
ii)	0702	Positive displacement pump	<p>PLUNGER PUMP</p> <p>DUPLEX PUMP</p>	<p>RECIPROCATING PUMP</p>
iii)	0703	Proportioning pump		—
iv)	0704	Hand pump with drum		—
v)	0705	Ejector (vapour service)	<p>PROCESS FLUID</p> <p>MOTIVE FLUID</p>	—
vi)	0706	Blowing egg		—

SECTION 08 COMPRESSORS

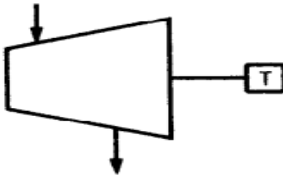
<i>Sl No.</i>	<i>Symbol No.</i>	<i>Description</i>	<i>Symbols</i>	<i>Remarks</i>
(1)	(2)	(3)	(4)	(5)
i)	0801	Centrifugal compressor		—
ii)	0802	Positive displacement compressor		—
iii)	0803	Reciprocating compressor		—
iv)	0804	Ejector compressor		—
v)	0805	Fan		—
vi)	0806	Turbine		—

SECTION 09 HEATING OR COOLING ARRANGEMENTS



<i>Sl No.</i>	<i>Symbol No.</i>	<i>Description</i>	<i>Symbols</i>	<i>Remarks</i>
(1)	(2)	(3)	(4)	(5)
i)	0901	Immersion coil	 	<p>EXAMPLES—</p>  

Table (Continued)







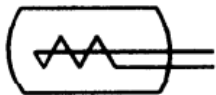
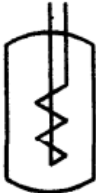

Sl No.	Symbol No.	Description	Symbols	Remarks
(1)	(2)	(3)	(4)	(5)
ii)	0902	Exchanger (in PFD)		—
iii)	0903	Heat exchanger		—
iv)	0904	Exchanger		—
v)	0905	Exchanger		—
vi)	0906	Kettle reboiler		—
vii)	0907	Kettle reboiler		—
viii)	0908	Kettle reboiler 2 – bundle		—
ix)	0909	Tubular coil		EXAMPLE :- 
x)	0910	Jacket		EXAMPLE :- 

Table (Continued)

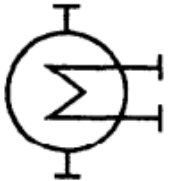
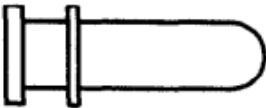

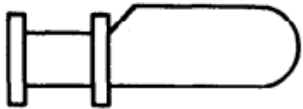

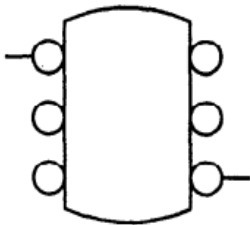
Sl No.	Symbol No.	Description	Symbols	Remarks
(1)	(2)	(3)	(4)	(5)
xi)	0911	Natural draught cooling tower		—
xii)	0912	Induced draught cooling tower		—
xiii)	0913	Air blown cooler		Used for PFD
xiv)	0914	Trickle cooler		—
xv)	0915	Plate type heat exchanger		—
xvi)	0916	Air cooler with fan and motor		Used for P&I
xvii)	0917	Contact condenser		—
xviii)	0918	Desuper heater		—

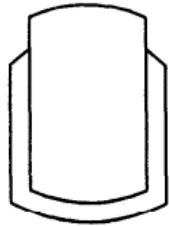
Table (Concluded)

<i>Sl No.</i>	<i>Symbol No.</i>	<i>Description</i>	<i>Symbols</i>	<i>Remarks</i>
(1)	(2)	(3)	(4)	(5)
xix)	0919	One cell fired heater/furnace		—
xx)	0920	Two cell fired heater/furnace		—

SECTION 10 FURNACES AND BOILERS

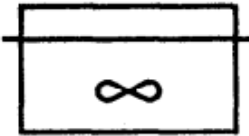
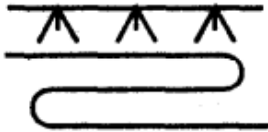
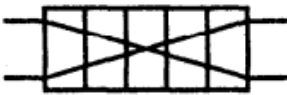
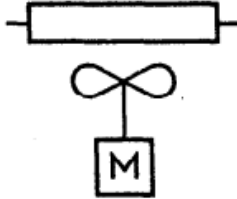
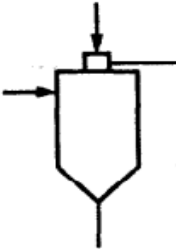
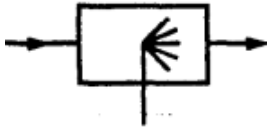
<i>Sl No.</i>	<i>Symbol No.</i>	<i>Description</i>	<i>Symbols</i>	<i>Remarks</i>
(1)	(2)	(3)	(4)	(5)
i)	1001	Solid fuel furnace		—
ii)	1002	Oil, gas or pulverized fuel furnace		—
iii)	1003	Electric furnace		—
iv)	1004	Fired boiler		—
v)	1005	Waste heat boiler		—

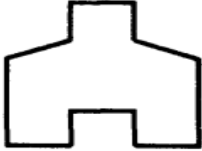
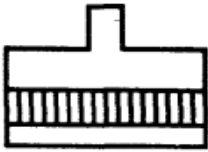
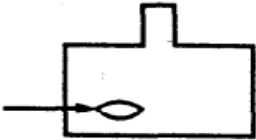
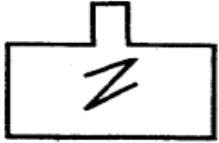
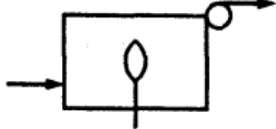
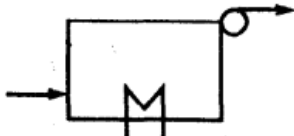
SECTION 11 PROCESS VESSELS







<i>Sl No.</i>	<i>Symbol No.</i>	<i>Description</i>	<i>Symbols</i>	<i>Remarks</i>
(1)	(2)	(3)	(4)	(5)
i)	1101	Horizontal vessel		—
ii)	1102	Vertical vessel		—
iii)	1103	Jacketed vessel		—
iv)	1104	Packed vessel		—
v)	1105	Evaporator		—
vi)	1106	Crystallizer		—
vii)	1107	Autoclave		—
viii)	1108	Construction inside containers, columns towers and reactors		—

Table (Continued)

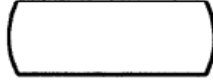



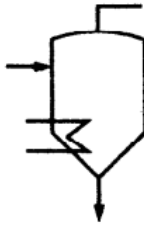
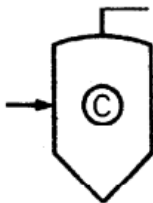

Sl No.	Symbol No.	Description	Symbols	Remarks
(1)	(2)	(3)	(4)	(5)
ix)	1108A	Plates/trays (for mass transfer)		 <p><i>Example:</i> Tray should be numbered from the bottom at least the first and last should be shown. Intermediate tray should be included and numbered where they are significant.</p>
x)	1108B	Fluidized bed		
xi)	1109	Multi bed packed column		—
xii)	1110	Vessel with boot		—
xiii)	1111	Deaerator		—
xiv)	1112	Flanged vessel		—
xv)	1113	Double flanged vessel		—
xvi)	1114	Conical bottom vessel		—

Table (Concluded)

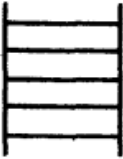
<i>Sl No.</i>	<i>Symbol No.</i>	<i>Description</i>	<i>Symbols</i>	<i>Remarks</i>
(1)	(2)	(3)	(4)	(5)
xvii)	1115	Vessel with one-sump		—
xviii)	1116	Vessel with two-sumps		—

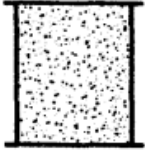
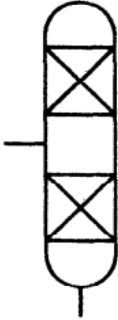
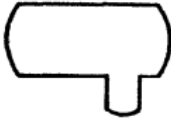
SECTION 12 STORAGE VESSELS/TANKS

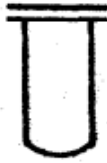
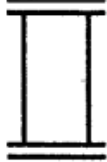
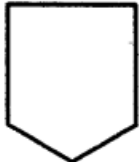
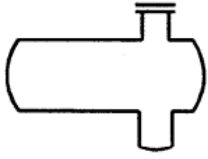
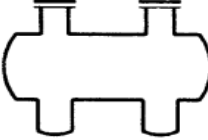
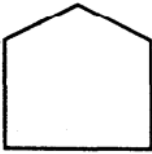
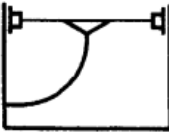
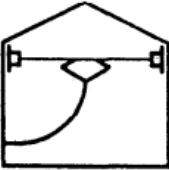
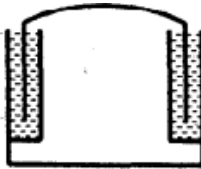
<i>Sl No.</i>	<i>Symbol No.</i>	<i>Description</i>	<i>Symbols</i>	<i>Remarks</i>
(1)	(2)	(3)	(4)	(5)
i)	1201	Fixed roof tank		—
ii)	1202	Floating roof tank		—
iii)	1203	Floating cum fixed roof tank		—
iv)	1204	Gas holder, wet seal		—
v)	1205	Gas holder, dry seal		—
vi)	1206	Pressure storage (sphere or spheroid) Horton sphere		—

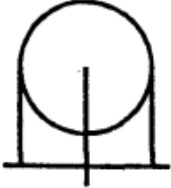
SECTION 13 DRYERS

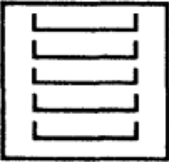
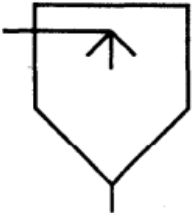
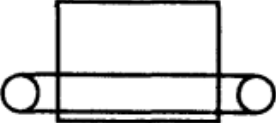
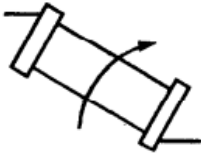
<i>Sl No.</i>	<i>Symbol No.</i>	<i>Description</i>	<i>Symbols</i>	<i>Remarks</i>
(1)	(2)	(3)	(4)	(5)
i)	1301	Batch tray drier		—
ii)	1302	Spray drier		—
iii)	1303	Continuous drier		—
iv)	1304	Rotary drier or kiln		—

SECTION 14 SIZE REDUCTION EQUIPMENTS







<i>Sl No.</i>	<i>Symbol No.</i>	<i>Description</i>	<i>Symbols</i>	<i>Remarks</i>
(1)	(2)	(3)	(4)	(5)
i)	1401	Size reducing equipment (general symbol)		<i>Example: Pulverizer</i>
ii)	1402	Breaker, gyratory		—
iii)	1403	Breaker hammer mill impact mill		—

Table (Concluded)

<i>Sl No.</i>	<i>Symbol No.</i>	<i>Description</i>	<i>Symbols</i>	<i>Remarks</i>
(1)	(2)	(3)	(4)	(5)
iv)	1404	Jaw crusher		—
v)	1404A	Roller crusher		—
vi)	1405	Grinder		—
vii)	1406	Ball or Tube mill		—

SECTION 15 SEPARATORS

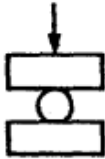
<i>Sl No.</i>	<i>Symbol No.</i>	<i>Description</i>	<i>Symbols</i>	<i>Remarks</i>
(1)	(2)	(3)	(4)	(5)
i)	1501	Cyclone or hydrocyclone		—
ii)	1502	Electrostatic separator (electrical purification of gas)		—
iii)	1503	Separators for liquids, decanters		—

Table (Concluded)

Sl No.	Symbol No.	Description	Symbols	Remarks
(1)	(2)	(3)	(4)	(5)
iv)	1504	Thickener		—
v)	1505	Screen	<p>SCREEN, VIBRATORY</p> 	<p>SCREEN, ROTARY</p> 

SECTION 16 FILTERS



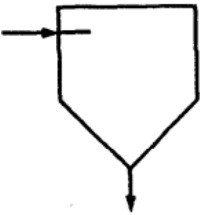
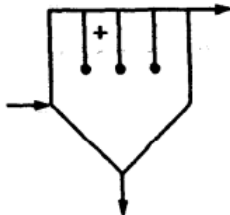
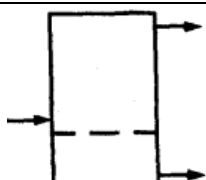
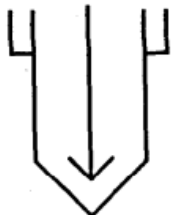
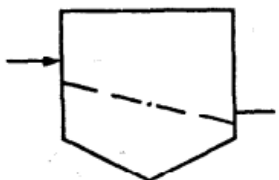
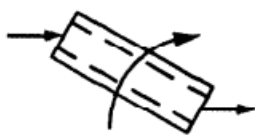

Sl No.	Symbol No.	Description	Symbols	Remarks
(1)	(2)	(3)	(4)	(5)
i)	1601	Filter press		—
ii)	1602	Suction filter		—
iii)	1603	Pressure filter		—
iv)	1604	Gravity filter (open settling tank)		—
v)	1605	Open rotary vacuum filter		—
vi)	1606	Closed rotary vacuum filter		—

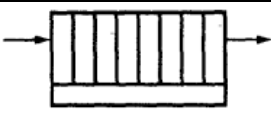
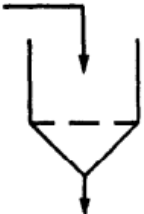
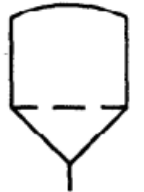
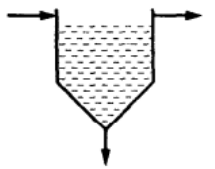

Table (Concluded)

Sl No.	Symbol No.	Description	Symbols	Remarks
(1)	(2)	(3)	(4)	(5)
vii)	1607	Bag filter		BASKET FILTER 



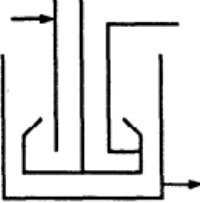
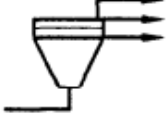
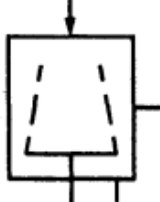
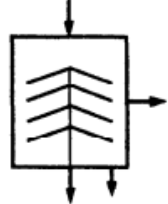

SECTION 17 CENTRIFUGES

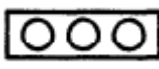
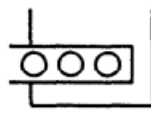
Sl No.	Symbol No.	Description	Symbols	Remarks
(1)	(2)	(3)	(4)	(5)
i)	1701	Centrifuges (general symbol)		ALTERNATIVE 
ii)	1702	Basket centrifuge batch or continuous		—
iii)	1703	Plate centrifuge		—

SECTION 18 STIRRERS

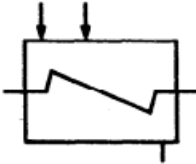
Sl No.	Symbol No.	Description	Symbols	Remarks
(1)	(2)	(3)	(4)	(5)
i)	1801	General symbol		EXAMPLE:- 
ii)	1802	Sparger		EXAMPLE:- 

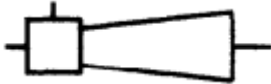
SECTION 19 MIXERS

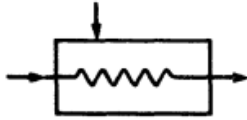
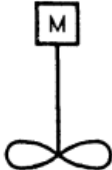
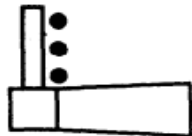
<i>Sl No.</i>	<i>Symbol No.</i>	<i>Description</i>	<i>Symbols</i>	<i>Remarks</i>
(1)	(2)	(3)	(4)	(5)
i)	1901	Ribbon blender		—
ii)	1902	Kneader		—
iii)	1903	Double cone blender		—
iv)	1904	Ejector mixer		—
v)	1905	Rotary mixer		—
vi)	1906	On-line mixer		—
vii)	1907	Mixer		—
viii)	1908	Saucony mixer		—

SECTION 20 FEEDERS

<i>Sl No.</i>	<i>Symbol No.</i>	<i>Description</i>	<i>Symbols</i>	<i>Remarks</i>
(1)	(2)	(3)	(4)	(5)
i)	2001	General symbol		—

Table (Concluded)

<i>Sl No.</i>	<i>Symbol No.</i>	<i>Description</i>	<i>Symbols</i>	<i>Remarks</i>
(1)	(2)	(3)	(4)	(5)
ii)	2002	Vibrator feeder		—
iii)	2003	Weigh feeder		—
iv)	2004	Rotary table feeder, revolving plate feeder		—
v)	2005	Scraper feeder		—
vi)	2006	Screw feeder		—
vii)	2007	Rotary feeder		—

SECTION 21 CONVEYORS

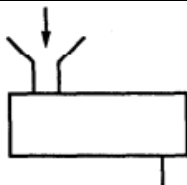
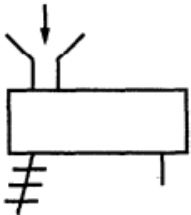
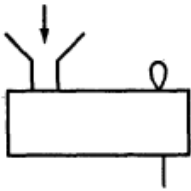
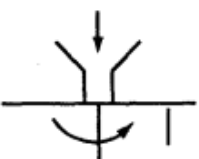
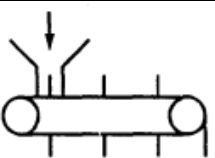
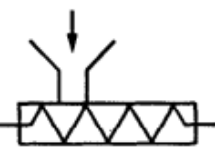
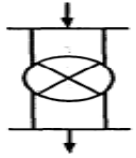

<i>Sl No.</i>	<i>Symbol No.</i>	<i>Description</i>	<i>Symbols</i>	<i>Remarks</i>
(1)	(2)	(3)	(4)	(5)
i)	2101	Belt conveyor		—
ii)	2102	Scraper conveyor		—

Table (Concluded)

Sl No.	Symbol No.	Description	Symbols	Remarks
(1)	(2)	(3)	(4)	(5)
iii)	2103	Vibrating conveyor		—
iv)	2104	Screw conveyor		—
v)	2105	Bucket conveyor		—
vi)	2106	Roller conveyor		—
vii)	2107	Overhead conveyor with hooks		—
viii)	2107B	Overhead conveyor or ropeway with buckets or carriers		—
ix)	2108A	Fixed hoist with hook		—
x)	2108B	Travelling hoist with hook		—
xi)	2108C	Travelling hoist with grab		—
xii)	2108D	Air floats		—

SECTION 22 TRANSPORT VEHICLES

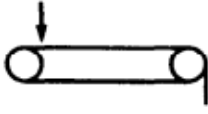
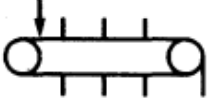
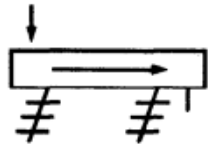
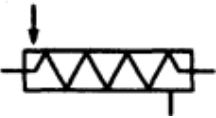
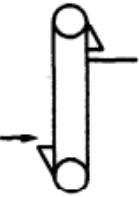
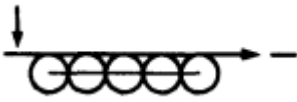
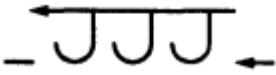
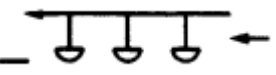

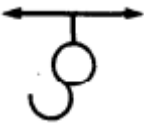
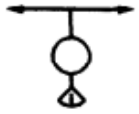
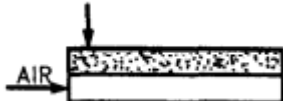
Sl No.	Symbol No.	Description	Symbols	Remarks
(1)	(2)	(3)	(4)	(5)
i)	2201	Ship		—

Table (Concluded)

<i>Sl No.</i>	<i>Symbol No.</i>	<i>Description</i>	<i>Symbols</i>	<i>Remarks</i>
(1)	(2)	(3)	(4)	(5)
ii)	2202	Wagon, lorry, truck		—
iii)	2203	Tanker		—
iv)	2204	Open trailer		—
v)	2205	Wagon with bottom hopper		—

SECTION 23 MISCELLANEOUS

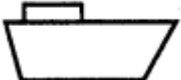
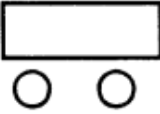
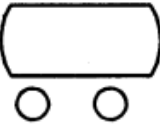
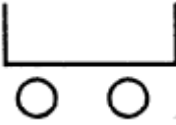
<i>Sl No.</i>	<i>Symbol No.</i>	<i>Description</i>	<i>Symbols</i>	<i>Remarks</i>
(1)	(2)	(3)	(4)	(5)
i)	2301	Silencer		—
ii)	2302	Launcher receiver		—
iii)	2303	Diesel generator		—
iv)	2304	Turbine generator		—

Table (Continued)



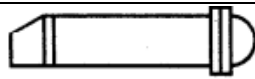
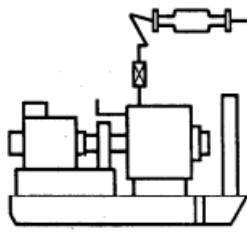
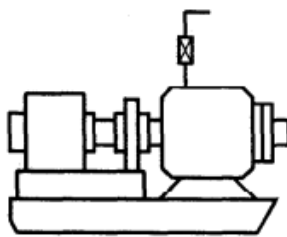

Sl No.	Symbol No.	Description	Symbols	Remarks
(1)	(2)	(3)	(4)	(5)
v)	2305	Hose reel		
vi)	2306A	Well head with one bore (single completion)		—
vii)	2306B	Well head with two bore (dual completion)		—
viii)	2307	Sump caisson		—
ix)	2308	Flare		—
x)	2308B	Flare stack		—

Table (Continued)



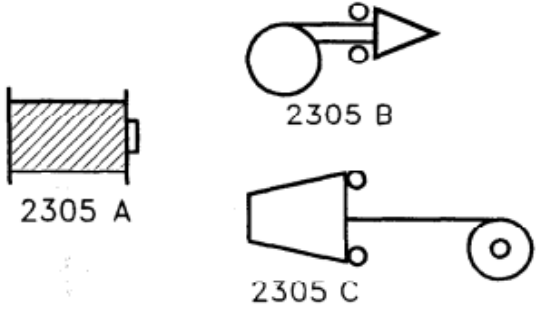

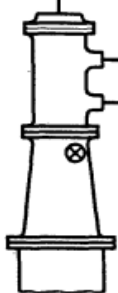
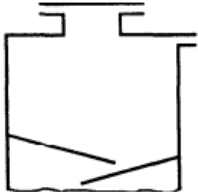
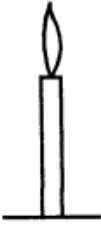

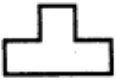

<i>Sl No.</i>	<i>Symbol No.</i>	<i>Description</i>	<i>Symbols</i>	<i>Remarks</i>
(1)	(2)	(3)	(4)	(5)
xi)	2309	Chimney		—
xii)	2310	Scraper tee		—
xiii)	2311	Atmospheric vent		—
xiv)	2312	Cylinder		—
xv)	2313	Graduated cylinder		—
xvi)	2314	Crane		—
xvii)	2315A	Electrolytic cell without diaphragm		—
xviii)	2315B	Electrolytic cell with diaphragm		—
xix)	2316	Turbine drive		—
xx)	2317	Motor drive		—

Table (Concluded)

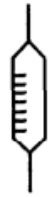
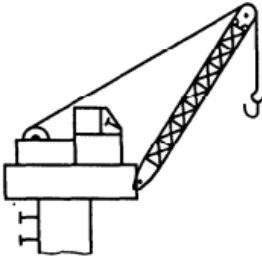
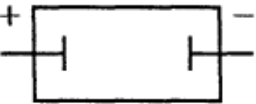
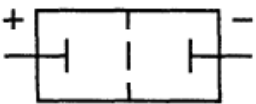
<i>Sl No.</i>	<i>Symbol No.</i>	<i>Description</i>	<i>Symbols</i>	<i>Remarks</i>
(1)	(2)	(3)	(4)	(5)
xxi)	2318	Swivel drain		—
xxii)	2319	CBD-symbol		—
xxiii)	2320	Sample cooler		

SECTION 24 SERVICE FLUID CODES

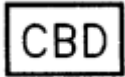
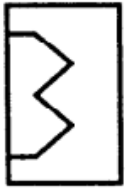
<i>Sl No.</i>	<i>Codes</i>	<i>Meaning</i>
(1)	(2)	(3)
i)	P	Process
ii)	WCS	Cooling water supply
iii)	WCR	Cooling water return
iv)	WD	Drinking water
v)	WS	Service water
vi)	WF	Fire water
vii)	WR	Raw water
viii)	WP	Process water
ix)	WT	Treated water
x)	AI	Instrument air
xi)	AP	Plant air
xii)	AB	Breathing air
xiii)	BD	Blow down
xiv)	FL	Flare
xv)	FO	Fuel oil
xvi)	FG	Fuel gas
xvii)	GI	Instrument gas
xviii)	IG	Inert gas
xix)	OWS	Only water sewer
xx)	SS	Strom sever
xxi)	CBD	Closed blow down
xxii)	D	Drain
xxiii)	UC	Utility connection
xxiv)	HM	Heating medium
xxv)	HMS	Heating medium supply
xxvi)	HMR	Heating medium return

Table (Concluded)

<i>Sl No.</i>	<i>Codes</i>	<i>Meaning</i>
(1)	(2)	(3)
xxvii)	EG	50 percent EG solution
xxviii)	CHWS	Chilled water supply
xxix)	CHWR	Chilled water return
xxx)	WDM	Demineralised water
xxxi)	SH	SP steam
xxxii)	SM	MP steam
xxxiii)	SL	LP steam
xxxiv)	CH	Condensate HP
xxxv)	CM	Condensate MP
xxxvi)	CL	Condensate LP
xxxvii)	N	Nitrogen
xxxviii)	BR	Brine
xxxix)	CS	Caustic sewer
xl)	NA	Caustic
xli)	RE	Refrigerant ethane
xl ii)	RA	Refrigerant ammonia
xliii)	RP	Refrigerant propane
xliv)	AC	Acid lines

SECTION 25 INSULATION/TRACING TYPE

<i>Sl No.</i>	<i>Codes</i>	<i>Meaning</i>
(1)	(2)	(3)
i)	IH	Hot insulation
ii)	IC	Cold insulation
iii)	IS	Safety insulation
iv)	IT	Steam traced
v)	IE	Electric traced
vi)	IA	Acoustic insulation
vii)	IF	Thermal fluid tracing

ANNEX A

(Foreword)

COMMITTEE COMPOSITION

Chemical Engineering Plants and Related Equipment Sectional Committee, MED 17

<i>Organization</i>	<i>Representative(s)</i>
CSIR - Indian Institute of Petroleum, Dehradun	DR MRITUNJAY KUMAR SHUKLA (<i>Chairperson</i>)
Advance Valves Global, Noida	SHRI PRANAY S. GARG SHRI CHANDRAKANT WADKAR (<i>Alternate</i>)
Auma India Private Limited, Bengaluru	SHRI YASHWANT M. JANNU
Bharat Heavy Electrical Limited, New Delhi	SHRI Y. SRINIVASA RAO SHRI ABHISHEK KUMAR PANDEY (<i>Alternate</i>)
Blast Carboblocks Private Limited, Mumbai	SHRI DHAWAL SAXENA
Central Power Research Institute, Bengaluru	DR P. THOMAS SHRI SADASIVA MURTHY P. (<i>Alternate I</i>) SHRI AJITH KUMAR N. (<i>Alternate II</i>)
Chemtrols Industries Private Limited, New Delhi	SHRI P. KRISHNA KUMAR
Confederation of Indian Industry, New Delhi	SHRI NANDAKUMAR KALATH SHRI ABILASH UTTAM (<i>Alternate</i>)
Directorate General Factory Advice Service and Labour Institutes, Mumbai	SHRI TANOJ CHANDAN SHRI KUNAL SHARMA (<i>Alternate</i>)
Engineers India Limited, Gurugram	SHRI HASMUKH K. PARMAR SHRI MRAGANG SHEAKHAR (<i>Alternate</i>)
GMM Pfaudler Limited, Anand	SHRI DHIRAN PANCHAL SHRI SATVIK PATEL (<i>Alternate</i>)
Hindustan Petroleum Corporation Limited, Mumbai	SHRI KRISHANU GHOSH SHRI N.K. RAI (<i>Alternate</i>)
Indian Oil Corporation Limited, New Delhi	SHRI KARAN AGRAWAL
Indian Rubber Manufacturers Research Association, Mumbai	DR K. RAJ KUMAR DR DEBDIPTA BASU (<i>Alternate</i>)
Indian Valve and Actuator Manufacturers Association (IVAMA), Coimbatore	SHRI R. MURUGANANTHAM SHRI JAY DOSHI (<i>Alternate</i>)
Kejriwal Casting Limited, Kolkata	SHRI SANDEEP KEJRIWAL
L&T Valves, Chennai	SHRI ROHIT SHARMA SHRI SURIYANARAYANAN (<i>Alternate</i>)
Lathia Rubber Manufacture Company Private Limited, Mumbai	SHRI SANJIV S. LATHIA
MECON Limited, Ranchi	SHRI YOGENDRA KUMAR SINGH SHRI ARVIND BHUSHAN (<i>Alternate</i>)

<i>Organization</i>	<i>Representative(s)</i>
Plastics Machinery Manufacturers Association of India (PMMAI), New Delhi	SHRI NANDHA KUMAR T. SHRI PRADIP VANWANI (<i>Alternate</i>)
Project and Development India Limited, Noida	SHRI SANJIV KUMAR MISHRA SHRI RAJEEV RANJAN KUMAR (<i>Alternate</i>)
Tata Consulting Engineers Limited, Navi Mumbai	SHRI SHIVNARAYAN PAREEK SHRI SHIREESH S. SWAMI (<i>Alternate</i>)
BIS Directorate General	SHRI NAVINDRA GAUTAM SCIENTIST 'E'/DIRECTOR AND HEAD (MECHANICAL ENGINEERING) [REPRESENTING DIRECTOR GENERAL (<i>Ex-officio</i>)]

Member Secretary
MS NEHA THAKUR
SCIENTIST 'B'/ASSISTANT DIRECTOR
(MECHANICAL ENGINEERING), BIS

Bureau of Indian Standards

BIS is a statutory institution established under the *Bureau of Indian Standards Act, 2016* to promote harmonious development of the activities of standardization, marking and quality certification of goods and attending to connected matters in the country.

Copyright

BIS has the copyright of all its publications. No part of these publications may be reproduced in any form without the prior permission in writing of BIS. This does not preclude the free use, in the course of implementing the standard, of necessary details, such as symbols and sizes, type or grade designations. Enquiries relating to copyright be addressed to the Head (Publication & Sales), BIS.

Review of Indian Standards

Amendments are issued to standards as the need arises on the basis of comments. Standards are also reviewed periodically; a standard along with amendments is reaffirmed when such review indicates that no changes are needed; if the review indicates that changes are needed, it is taken up for revision. Users of Indian Standards should ascertain that they are in possession of the latest amendments or edition by referring to the website-www.bis.gov.in or www.standardsbis.in.

This Indian Standard has been developed from Doc No.: MED 17 (19915).

Amendments Issued Since Publication

Amend No.	Date of Issue	Text Affected

BUREAU OF INDIAN STANDARDS

Headquarters:

Manak Bhavan, 9 Bahadur Shah Zafar Marg, New Delhi 110002

Telephones: 2323 0131, 2323 3375, 2323 9402

Website: www.bis.gov.in

Regional Offices:

	Telephones
Central : 601/A, Konnectus Tower -1, 6 th Floor, DMRC Building, Bhavbhuti Marg, New Delhi 110002	{ 2323 7617
Eastern : 8 th Floor, Plot No 7/7 & 7/8, CP Block, Sector V, Salt Lake, Kolkata, West Bengal 700091	{ 2367 0012 2320 9474
Northern : Plot No. 4-A, Sector 27-B, Madhya Marg, Chandigarh 160019	{ 265 9930
Southern : C.I.T. Campus, IV Cross Road, Taramani, Chennai 600113	{ 2254 1442 2254 1216
Western : Plot No. E-9, Road No.-8, MIDC, Andheri (East), Mumbai 400093	{ 2821 8093

Branches : AHMEDABAD. BENGALURU. BHOPAL. BHUBANESHWAR. CHANDIGARH. CHENNAI. COIMBATORE. DEHRADUN. DELHI. FARIDABAD. GHAZIABAD. GUWAHATI. HIMACHAL PRADESH. HUBLI. HYDERABAD. JAIPUR. JAMMU & KASHMIR. JAMSHEDPUR. KOCHI. KOLKATA. LUCKNOW. MADURAI. MUMBAI. NAGPUR. NOIDA. PANIPAT. PATNA. PUNE. RAIPUR. RAJKOT. SURAT. VISAKHAPATNAM.