

भारतीय मानक

IS 1252 : 2024

Indian Standard

(Amalgamating IS 1863 and IS 1864)

जहाज़ निर्माण के लिए तप्त बेल्लित इस्पात
अनुभाग — आयाम और छूटें

(दूसरा पुनरीक्षण)

Hot Rolled Steel Sections for
Shipbuilding — Dimensions and
Tolerances

(Second Revision)

ICS 11.040.10; 11.140

© BIS 2024



भारतीय मानक ब्यूरो

BUREAU OF INDIAN STANDARDS

मानक भवन, 9 बहादुर शाह ज़फर मार्ग, नई दिल्ली - 110002

MANAK BHAVAN, 9 BAHADUR SHAH ZAFAR MARG
NEW DELHI - 110002

www.bis.gov.in www.standardsbis.in

October 2024

Price Group 8

FOREWORD

This Indian Standard (Second Revision) was adopted by the Bureau of Indian Standards, after the draft finalized by the Structural Engineering and Structural Sections Sectional Committee had been approved by the Civil Engineering Division Council.

Bulb angles, bulb flats and 'L' sections are generally used in shipbuilding industries. In the preparation of this standard the Sectional Committee specially kept in view the requirements of these industries.

Bureau of Indian Standards had first published IS 1252 for bulb angles in 1958, IS 1863 for bulb flats in 1961 and IS 1864 for 'L' section in 1963. Their first revisions were published as follows:

- IS 1252 : 1991 Hot rolled steel bulb angles — Dimensions (*first revision*)
- IS 1863 : 1979 Specification for rolled steel bulb flats (*first revision*)
- IS 1864 : 1979 Specification for hot rolled steel 'L' sections for shipbuilding (*first revision*)

In this revision, in view of the recent developments that have taken place, the Committee viewed that these standards be revised and amalgamated into one standard, that is, IS 1252. The amalgamation will facilitate better access of the sectional details under one resource document. The following additional modifications have been effected in this revision:

- a) References clause has been updated;
- b) Dimensions and sectional properties values of section has been updated; and
- c) Provision relating to customization of sizes has been added.

In the formulation of this standard, assistance has been derived from EN 10067 : 1996 'Hot rolled bulb flats — Dimensions and tolerances on shape, dimensions and mass.

This standard also aims at satisfying some Sustainable Development Goals by United Nations, especially Goal 9 'Industry, innovation and infrastructure', particularly its target **9.1**.

The composition of the Committee responsible for the formulation of this standard is given in [Annex A](#).

For the purpose of deciding whether a particular requirement of this standard is complied with, the final value, observed or calculated, expressing the results of a test or analysis, shall be rounded off in accordance with IS 2 : 2022 'Rules for rounding off numerical values (*second revision*)'. The number of significant places retained in the rounded off value should be the same as that of the specified value in this standard.

Indian Standard

HOT ROLLED STEEL SECTIONS FOR SHIPBUILDING —
DIMENSIONS AND TOLERANCES

(Second Revision)

1 SCOPE

This standard specifies the nominal dimensions, mass and sectional properties and dimensional tolerances of hot rolled steel bulb angles, bulb flats, and 'L' sections for shipbuilding.

2 REFERENCE

The standards given below contain provisions which through reference in this text, constitute provision of this standard. At the time of publication, the editions indicated were valid. All standards are subject to revision and parties to agreements based on this standard are encouraged to investigate the possibility of applying the most recent edition of these standards:

IS No.	Title
IS 808 : 2021	Hot rolled steel beam, column, channel and angle sections — Dimensions and properties (<i>fourth revision</i>)
IS 1852 : 1985	Specification for rolling and cutting tolerances for hot-rolled steel products (<i>fourth revision</i>)
IS 2062 : 2011	Hot rolled medium and high tensile structural steel — Specification (<i>seventh revision</i>)
IS 3039 : 2024	Structural steel for ship construction — Specification (<i>third revision</i>)

3 TERMINOLOGY

For the purpose of this standard, the definitions given in IS 2062 and the following shall apply.

3.1 U-U and V-V Axis — Lines passing through the centre of gravity of the profile of the section, representing the principal axes of the section where U-U is the major axis and V-V is the minor axis.

3.2 Y-Y Axis — A line passing through the centre of gravity of the profile of the sections and parallel to the axis of the web.

3.3 Z-Z Axis — A line passing through the centre of gravity of the profile along the length of the sections.

4 MATERIAL

The bulb flats may be manufactured from steel conforming to IS 2062 and IS 3039 as appropriate.

NOTE — As these sections are intended mainly to be used in shipbuilding, the steel shall, when so required, conform to the specification quoted by the purchaser.

5 SYMBOLS

Letter symbols used in this standard have been indicated in the figure in [Table 1](#). More explicit definitions for certain symbols used in the table and figure are given below:

a	Sectional area in mm ²
C_{yy}	Distance of centre of gravity of the section from the back line of the web
C_{zz}	Distance of centre of gravity of the section from the back line of the flange
D	Projection of the bulb from the inside face of the web
e_{yy}	Distance of extreme fibre from the Y-Y axis
e_{zz}	Distance of extreme fibre from the Z-Z axis
I_{uu}	Moment of inertia (<i>Max</i>) about the U-U axis
I_{vv}	Moment of inertia (<i>Max</i>) about the V-V axis
I_{yy}	Moment of inertia about the Y-Y axis
I_{zz}	Moment of inertia about the Z-Z axis
m	Nominal mass in kg per m = 0.785 a
r_{uu}	$\sqrt{\frac{I_{uu}}{a}}$ = Radius of gyration about the U-U axis
r_{vv}	$\sqrt{\frac{I_{vv}}{a}}$ = Radius of gyration about the V-V axis

To access Indian Standards click on the link below:

https://www.services.bis.gov.in/php/BIS_2.0/bisconnect/knowyourstandards/Indian_standards/isdetails/

$r_{yy} = \sqrt{\frac{I_{yy}}{a}}$ = Radius of gyration about the Y-Y axis

$r_{zz} = \sqrt{\frac{I_{zz}}{a}}$ = Radius of gyration about the Z-Z axis

$Z_{yy} = \frac{I_{yy}}{c_{yy}}$ = Modulus of section about Y-Y axis

$Z_{zz} = \frac{I_{zz}}{c_{zz}}$ = Modulus of section about Z-Z axis

α = Angle between the U-U axis and Z-Z axis

6 DESIGNATION

6.1 Hot rolled steel bulb angles conforming to this standard shall be designated by letters (BA) followed by a figure denoting the depth of longer side of the angle in mm * and ** to denote heavier sections.

6.2 The bulb flats conforming to this standard shall be designated by the width (b) and thickness (t).

Example:

200 × 10

6.3 'L' angle sections with unequal width and thickness shall be designated by the alphabet 'L' followed by height of web (H), width of flange (B),

thickness of web (t) and thickness of flange (T).

Example:

L 250 × 90 × 9 × 13

7 DIMENSIONS

7.1 The dimensions and mass of bulb angle sections shall be as given in [Fig. 1](#) and [Table 1](#). Sectional properties of the bulb angle sections have been given in [Table 1](#) for information.

NOTE — A new range of sections suiting to the need of the design requirements can be produced based on the formulae to calculate the geometrical sectional properties as per Annex A and Annex B of IS 808 that fulfils the design criteria or as agreed between purchaser and user.

7.2 The dimensions and mass of bulb flat sections shall be as given in [Fig. 2](#) and [Table 2](#). Sectional properties of the bulb flat sections have been given in [Table 2](#) for information.

NOTE — Other sections of bulb flats may also be manufactured by mutual arrangement between the supplier and the manufacturer subject to the tolerances given in this standard.

7.3 The dimensions and mass of 'L' sections shall be as given in [Fig. 3](#) and [Table 3](#). Sectional properties of 'L' sections have been given in [Table 3](#) for information.

NOTE — Other sections of bulb flats may also be manufactured by mutual arrangement between the supplier and the manufacturer subject to the tolerances given in this standard.

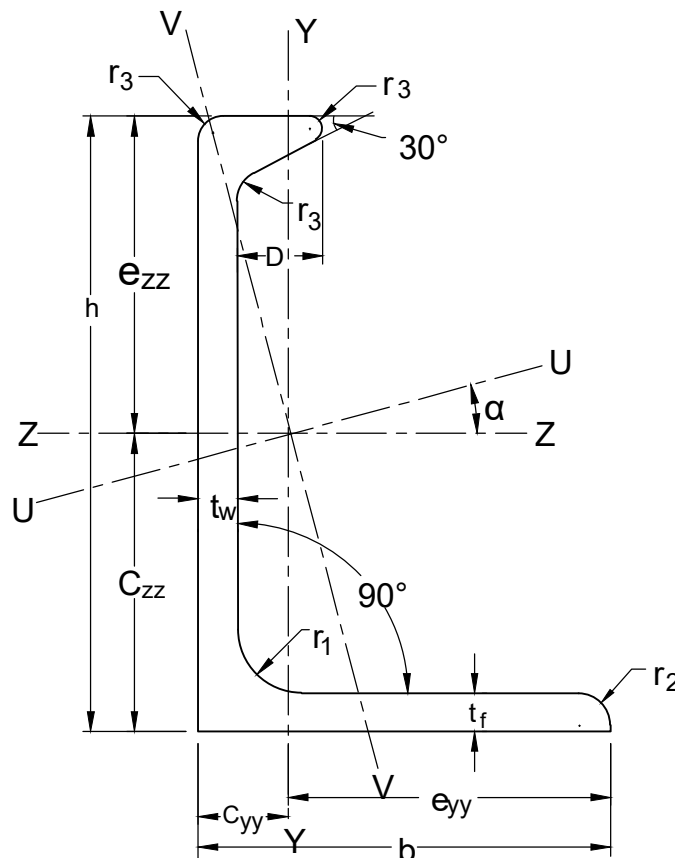

FIG. 1 HOT ROLLED STEEL BULB ANGLE

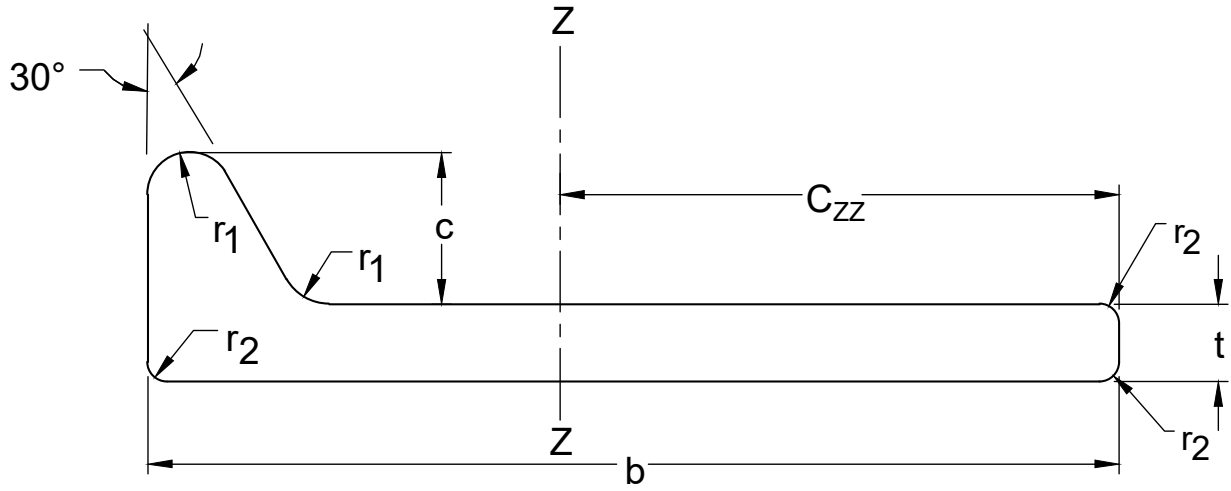

FIG. 2 TYPICAL BULB FLAT

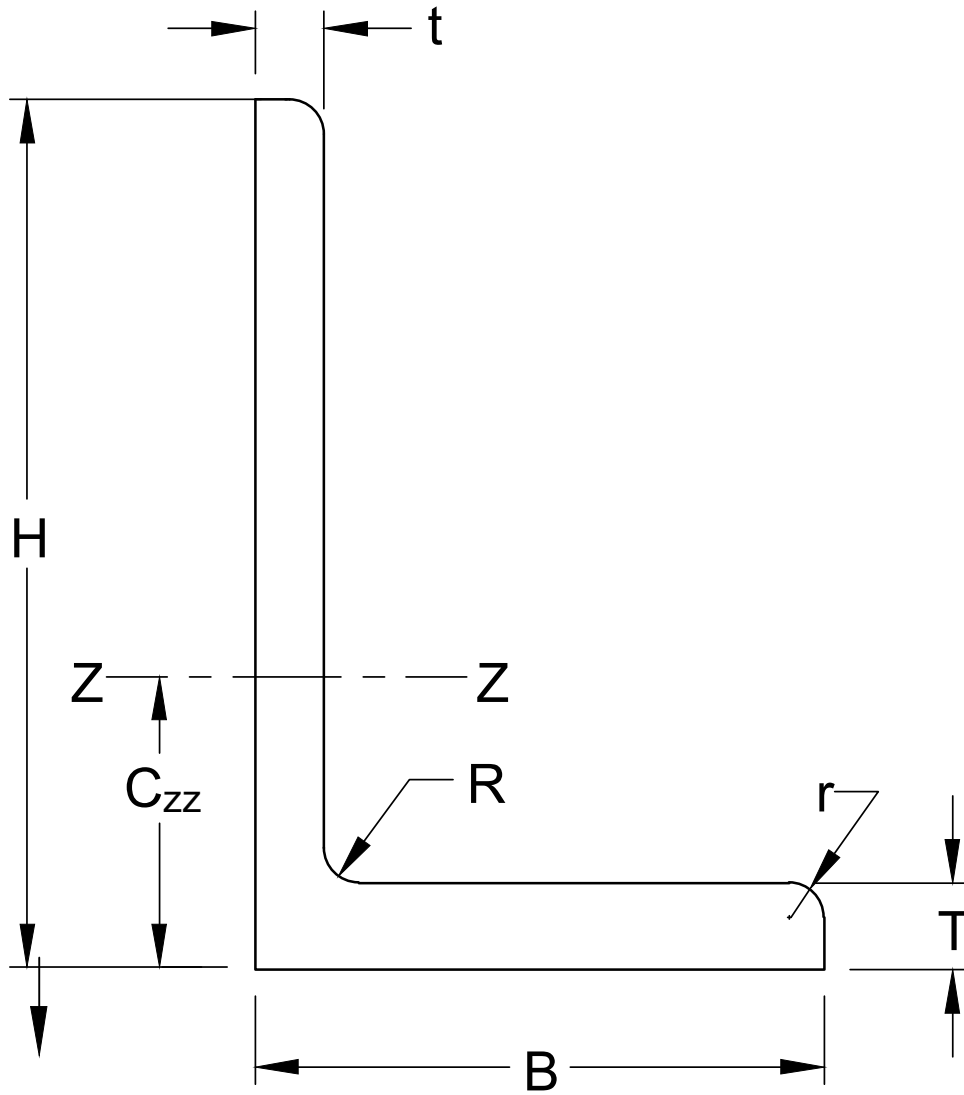

FIG. 3 TYPICAL 'L' SECTION

Table 1 Bulb Angles — Dimensions and Sectional Properties

(Clauses 5 and 7.1)

Sl No.	Designation	Mass per Meter	Sectional Area	Size	Thick-ness of Web	Thick-ness Flange	(D)	Radius at Root	Radius at Toe	Radius at Bulb Corners	Centre of Gravity		Distance of Extreme Fibres		Tan α	Moment of Inertia				Radii of Gyration				Moduli of Section	
								r_1	r_2	r_3	C_{zz}	C_{yy}	t_{zz}	t_{yy}		I_{zz}	I_{yy}	I_{zz} (Max)	I_{yy} (Min)	r_{zz}	r_{yy}	r_{uu} (Max)	r_{vv} (Min)	Z_{zz}	Z_{yy}
			kg		100* mm ²	mm × mm		mm	mm	mm	mm	mm	mm	mm		cm	cm	cm	cm	cm ⁴	cm ⁴	cm ⁴	cm ⁴	cm	cm
(1)	(2)	(3)	(4)	(5)	(6)	(7)	(8)	(9)	(10)	(11)	(12)	(13)	(14)	(15)	(16)	(17)	(18)	(19)	(20)	(21)	(22)	(23)	(24)	(25)	(26)
i)	BA 100	8.6	10.94	100 × 65	6.0	6.0	13	10.0	5.0	4.0	3.92	1.43	6.08	5.07	0.291	143	33.0	153	22.8	3.61	1.74	3.74	1.44	23.5	6.5
ii)	BA 100*	9.6	12.17	100 × 65	7.0	6.5	13	10.0	5.0	4.0	3.95	1.43	6.05	5.07	0.288	155	35.7	165	24.9	3.56	1.71	3.69	1.43	25.6	7.0
iii)	BA 125	12.2	15.60	125 × 75	7.0	7.0	16	11.0	5.5	5.0	5.06	1.60	7.44	5.90	0.248	322	60.4	339	43.3	4.54	1.97	4.66	1.67	43.2	10.2
iv)	BA 125*	13.4	17.11	125 × 75	8.0	7.5	16	11.0	5.5	5.0	5.08	1.61	7.42	5.89	0.246	344	64.6	362	46.6	4.49	1.94	4.60	1.65	46.4	11.0
v)	BA 150	16.1	20.45	150 × 75	8.0	8.0	20	11.0	5.5	6.0	6.52	1.55	8.48	5.95	0.167	613	71.4	628	55.9	5.47	1.87	5.54	1.65	72.2	12.0
vi)	BA 150*	18.8	23.94	150 × 75	10.0	9.0	20	11.0	5.5	6.0	6.53	1.57	8.47	5.93	0.162	686	79.8	703	63.4	5.36	1.83	5.42	1.63	81.1	13.5
vii)	BA 175	20.0	25.54	175 × 90	8.0	9.0	23	13.5	6.5	7.0	7.44	1.89	10.06	7.11	0.185	1 070	137	1 110	104	6.48	2.32	6.58	2.02	107	19.3
viii)	BA 175*	23.3	29.66	175 × 90	10.0	10.0	23	13.5	6.5	7.0	7.46	1.90	10.04	7.10	0.181	1 190	152	1 230	117	6.34	2.27	6.43	1.99	119	21.4
ix)	BA 175**	26.5	33.74	175 × 90	12.0	11.0	23	13.5	6.5	7.0	7.49	1.92	10.01	7.08	0.177	1 310	166	1 350	130	6.23	2.22	6.32	1.96	131	23.5
x)	BA 200	28.2	35.95	200 × 90	11.0	11.0	26	13.5	6.5	8.0	8.87	1.86	11.13	7.14	0.136	1 880	172	1 910	140	7.23	2.19	7.29	1.97	169	24.1

Table 1 (Concluded)

Sl No.	Designation	Mass per Meter	Sectional Area	Size	Thick-ness of Web	Thick-ness Flange	(D)	Radius at Root	Radius at Toe	Radius at Bulb Corners	Centre of Gravity		Distance of Extreme Fibres		Tan α	Moment of Inertia				Radii of Gyration				Moduli of Section	
											C_{zz}	C_{yy}	t_{zz}	t_{yy}		I_{zz}	I_{yy}	I_{zz} (Max)	I_{yy} (Min)	r_{zz}	r_{yy}	r_{uu} (Max)	r_{vv} (Min)	Z_{zz}	Z_{yy}
			a	t_w	t_f	r_1	r_2	r_3	cm	cm	cm	cm	cm ⁴	cm ⁴	cm ⁴	cm ⁴	cm	cm	cm	cm	cm ³	cm ³			
(1)	(2)	(3)	(4)	(5)	(6)	(7)	(8)	(9)	(10)	(11)	(12)	(13)	(14)	(15)	(16)	(17)	(18)	(19)	(20)	(21)	(22)	(23)	(24)	(25)	(26)
xi)	BA 200*	33.6	42.76	200 × 90	14.0	12.5	26	13.5	6.5	8.0	8.89	1.91	11.11	7.09	0.131	2 130	194	2 160	160	7.06	2.13	7.12	1.93	192	27.3
xii)	BA 225	31.4	39.94	225 × 90	11.0	11.0	29	13.5	6.5	9.0	10.4	1.80	12.10	7.20	0.103	2 660	179	2 690	152	8.17	2.12	8.21	1.95	220	24.9
xiii)	BA 225*	37.3	47.50	225 × 90	14.0	12.5	29	13.5	6.5	9.0	10.4	1.85	12.13	7.15	0.098	3 020	202	3 040	175	7.97	2.06	8.01	1.92	249	28.2
xiv)	BA 250	34.9	44.41	250 × 90	11.0	11.0	33	13.5	6.5	10.0	12.1	1.78	12.93	7.22	0.075	3 680	188	3 700	168	9.11	2.06	9.13	1.95	285	26.0
xv)	BA 250*	39.2	49.96	250 × 90	13.0	12.0	33	13.5	6.5	10.0	12.0	1.81	13.01	7.19	0.072	4 010	205	4 030	185	8.96	2.02	8.98	1.92	308	28.5
xvi)	BA 275	40.9	52.13	275 × 90	12.0	12.0	36	13.5	6.5	11.0	13.5	1.80	13.93	7.21	0.057	5 160	213	5 180	197	9.95	2.02	9.97	1.94	370	29.6
xvii)	BA 275*	45.6	58.15	300 × 90	14.0	13.0	36	13.5	6.5	11.0	13.4	1.83	14.05	7.17	0.054	5 580	231	5 600	215	9.80	1.99	9.81	1.92	397	32.2
xviii)	BA 300	47.5	60.47	275 × 90	13.0	13.0	39	13.5	6.5	12.0	15.0	1.82	15.02	7.18	0.042	7 030	241	7 050	229	10.8	2.00	10.8	1.95	468	33.6
xix)	BA 300*	52.6	66.96	300 × 90	15.0	14.0	39	13.5	6.5	12.0	14.9	1.86	15.08	7.14	0.040	7 570	260	7 580	248	10.6	1.97	10.6	1.92	502	36.4

NOTE — Sections carrying with * and ** in the designation are heavier sections in each size obtained from the same set of rolls as the lighter sections by spreading of the rolls. The width of flanges of these difference between of the webs. Therefore, while ordering these heavier sections, mass should be mentioned.

Table 2 Bulb Flats — Dimensions and Sectional Properties about Z-Z Axis(Clauses [7.2](#) and [8.2.5](#))

Sl No.	Designation	Mass	Sectional Area	Dimensions				Surface Area	Centroid		Sectional Properties	
				<i>b</i>	<i>t</i>	<i>c</i>	<i>r₁</i>		<i>C_{zz}</i>	<i>I_{zz}</i>	<i>Z_{zz}</i>	
				mm	mm	mm	mm		mm	cm ²	cm ²	cm ²
(1)	(2)	(3)	(4)	(5)	(6)	(7)	(8)	(9)	(10)	(11)	(12)	
i)	60 × 4	2.81	3.58	60	4	13	3.5	0.146	3.82	12.2	3.20	
ii)	60 × 5	3.28	4.18	60	5	13	3.5	0.148	3.70	14.4	3.89	
iii)	60 × 6	3.75	4.78	60	6	13	3.5	0.150	3.62	16.4	4.55	
iv)	80 × 5	4.25	5.41	80	5	14	4	0.189	4.90	33.87	6.91	
v)	80 × 6	4.87	6.20	80	6	14	4	0.192	4.78	39.0	8.15	
vi)	80 × 7	5.10	7.00	80	7	14	4	0.194	4.69	43.1	9.24	
vii)	80 × 8	6.12	7.80	80	8	14	4	0.196	4.62	48.0	10.39	
viii)	100 × 6	6.08	7.74	100	6	15.5	4.5	0.234	5.98	76.1	12.7	
ix)	100 × 7	6.86	8.74	100	7	15.5	4.5	0.236	5.87	85.3	14.5	
x)	100 × 8	7.65	9.74	100	8	15.5	4.5	0.238	5.78	94.3	16.3	
xi)	120 × 6	7.32	9.32	120	6	17	5	0.276	7.21	133	18.5	
xii)	120 × 7	8.25	10.1	120	7	17	5	0.278	7.07	148	21.0	
xiii)	120 × 8	9.19	11.7	120	8	17	5	0.280	6.96	164	23.6	
xiv)	140 × 7	9.74	12.4	140	7	19	5.5	0.320	8.31	241	29.0	
xv)	140 × 8	10.8	13.8	140	8	19	5.5	0.322	8.18	268	32.5	
xvi)	140 × 9	11.9	15.2	140	9	19	5.5	0.324	8.07	291	36.0	

Table 2 (Continued)

SI No.	Designation	Mass	Sectional Area	Dimensions				Surface Area	Centroid	Sectional Properties	
				b	t	c	r_1			C_{zz}	I_{zz}
				kg/m	cm ²	mm	mm		mm	mm	m ² /m
(1)	(2)	(3)	(4)	(5)	(6)	(7)	(8)	(9)	(10)	(11)	(12)
xvii)	140 × 10	13.1	16.6	140	10	19	5.5	0.326	7.92	316	39.8
xviii)	160 × 7	11.4	14.6	160	7	22	6	0.365	9.66	373	38.6
xix)	160 × 8	12.7	16.2	160	8	22	6	0.367	9.49	411	43.3
xx)	160 × 9	14.0	17.8	160	9	22	6	0.169	9.16	448	47.9
xxi)	160 × 10	15.3	18.4	160	10	22	6	0.371	9.93	485	52.5
xxii)	180 × 8	14.8	18.9	180	8	25	7	0.411	10.9	609	55.0
xxiii)	180 × 9	16.2	20.7	180	9	25	7	0.413	10.7	663	61.8
xxiv)	180 × 10	17.6	22.5	180	10	25	7	0.415	10.6	717	67.8
xxv)	180 × 11	19.04	24.26	180	11	25	7	0.417	10.47	770	73.5
xxvi)	200 × 9	18.5	23.6	200	9	28	8	0.457	12.1	841	77.7
xxvii)	200 × 10	20.1	25.6	200	10	28	8	0.459	11.9	1 021	85.0
xxviii)	200 × 11	21.74	27.66	200	11	28	8	0.461	11.82	1091	92.3
xxix)	200 × 11.5	22.5	28.6	200	11.5	28	8	0.462	11.7	1 130	96.2
xxx)	200 × 12	23.28	29.66	200	12	28	8	0.463	11.69	1164	99.5
xxxi)	220 × 9	21.0	26.8	220	9	31	9	0.50	13.6	1 300	95.3
xxxii)	220 × 10	22.8	29.0	220	10	31	9	0.503	13.4	1 400	105
xxxiii)	220 × 11	24.5	31.2	220	11	31	9	0.506	13.19	1496	114

Table 2 (Continued)

SI No.	Designation	Mass	Sectional Area	Dimensions				Surface Area	Centroid	Sectional Properties	
				b	t	c	r_1			C_{zz}	I_{zz}
				kg/m	cm ²	mm	mm		mm	mm	m ² /m
(1)	(2)	(3)	(4)	(5)	(6)	(7)	(8)	(9)	(10)	(11)	(12)
xxxiv)	220 × 12	26.22	33.4	220	12	31	9	0.507	13.04	1595	122
xxxv)	240 × 10	25.4	32.4	240	10	34	10	0.547	14.7	1 860	126
xxxvi)	240 × 11	27.4	34.9	240	11	34	10	0.549	14.6	2 000	137
xxxvii)	240 × 12	29.3	37.3	240	12	34	10	0.551	14.4	2 130	148
xxxviii)	260 × 10	28.3	36.1	260	10	37	11	0.593	16.2	2 470	153
xxxix)	260 × 11	30.3	38.7	260	11	37	11	0.593	16.0	2 610	162
xl)	260 × 12	32.4	41.3	260	12	37	11	0.595	15.8	2 770	175
xli)	280 × 10	30.3	39.8	280	10	40	12	0.635	17.8	3 130	178
xlii)	280 × 11	33.5	42.6	280	11	40	12	0.637	17.4	3 330	191
xliii)	280 × 12	35.7	45.5	280	12	40	12	0.639	17.2	3 550	206
xliv)	280 × 13	37.9	48.28	280	13	40	12	0.641	17.04	3757	221
xlv)	300 × 11	36.7	46.7	300	11	43	13	0.681	18.9	4 190	222
xlvi)	300 × 12	39.0	49.7	300	12	43	13	0.683	18.7	4 460	239
xlvii)	300 × 13	41.5	52.8	300	13	43	13	0.685	18.5	4 720	256
xlviii)	320 × 12	42.5	54.2	320	12	46	14	0.728	20.1	5 530	274
xlix)	320 × 13	45.0	57.4	320	13	46	14	0.730	19.9	5 850	294
l)	320 × 14	47.6	60.85	320	14	46	14	0.732	19.68	6 168	313

Table 2 (Concluded)

SI No.	Designation	Mass	Sectional Area	Dimensions				Surface Area	Centroid		Sectional Properties	
				b	t	c	r_1		C_{zz}	I_{zz}	Z_{zz}	
				kg/m	cm ²	mm	mm		mm	mm	m ² /m	mm
(1)	(2)	(3)	(4)	(5)	(6)	(7)	(8)	(9)	(10)	(11)	(12)	
li)	340 × 12	46.1	58.8	340	12	49	15	0.772	21.5	6 760	313	
lii)	340 × 13	48.86	62.24	340	13	49	15	0.774	21.34	7 152	335	
liii)	340 × 14	51.5	65.5	340	14	49	15	0.776	21.1	7 540	357	
liv)	340 × 15	54.2	69.2	340	15	49	15	0.778	20.9	7 920	379	
lv)	370 × 13	54.6	69.6	370	13	53.5	16.5	0.840	23.5	9 470	402	
lvi)	370 × 14	57.60	73.40	370	14	53.5	16.5	0.842	23.29	9 980	429	
lvii)	370 × 15	60.5	77.0	370	15	53.5	16.5	0.844	23.0	10 400	455	
lviii)	370 × 16	63.5	80.7	370	16	53.5	16.5	0.886	22.8	11 000	481	
lix)	400 × 14	63.9	81.4	400	14	58	18	0.908	25.5	12 900	507	
lx)	400 × 15	67.10	85.48	400	15	58	18	0.910	25.24	13 573	538	
lxi)	400 × 16	70.2	89.48	400	16	58	18	0.912	25.0	14 200	568	
lxii)	430 × 14	70.6	89.70	430	14	58	18	0.975	27.7	16 460	594	
lxiii)	430 × 15	73.9	94.1	430	15	62.5	19.5	0.976	27.4	17 300	628	
lxiv)	430 × 17	80.6	103	430	17	62.5	19.5	0.980	26.9	18 900	700	
lxv)	430 × 19	87.4	111.4	430	19	62.5	19.5	0.984	26.53	20 413	770	
lxvi)	430 × 20	90.8	115.0	430	20	62.5	19.5	0.986	26.30	21 180	804	

Table 3 'L' Sections — Dimensions and Sectional Properties

(Clauses 7.3 and 8.3.8)

SI No.	Designation	Mass	Dimensions						Sectional Area	Centroid	Moment of Inertia I_{ZZ}
			H	B	t	T	R	r			
		kg/m	mm	mm	mm	mm	mm	mm	cm ²	cm	cm ⁴
(1)	(2)	(3)	(4)	(5)	(6)	(7)	(8)	(9)	(10)	(11)	(12)
i)	L 75 × 50 × 6 × 8	6.25	75	50	6	8	6.5	4	8.0	2.20	48.0
ii)	L 100 × 50 × 8 × 10	11.0	100	65	8	10	11	5.5	13.7	3.13	137
iii)	L 100 × 75 × 12 × 15	16.8	100	75	12	15	11	5.5	21.4	3.13	197
iv)	L 125 × 75 × 10 × 12	15.8	125	75	10	12	13.5	6.5	20.3	4.08	917
v)	L 150 × 90 × 14 × 18	27.0	150	90	14	18	13.5	6.5	34.6	5.02	742
vi)	L 200 × 90 × 8 × 14	21.8	200	90	8	14	14	7	27.8	6.07	1 120
vii)	L 200 × 90 × 9 × 12	22.0	200	90	9	12	15	7.5	28.1	6.63	1 160
viii)	L 200 × 90 × 9 × 14	23.3	200	90	9	14	14	7	29.66	6.36	1 210
ix)	L 200 × 90 × 10 × 14	24.7	200	90	10	14	14	7	31.52	6.61	1 300
x)	L 225 × 90 × 9 × 12	23.8	225	90	9	12	15	7.5	30.3	7.71	1 610
xi)	L 225 × 90 × 10.5 × 14	27.6	225	90	10.5	14	15	7.5	35.1	7.80	1 850
xii)	L 225 × 90 × 10 × 15	29.4	250	90	10	15	15	7.5	37.5	8.61	2 440
xiii)	L 250 × 90 × 9 × 13	26.2	250	90	9	13	15	7.5	33.4	8.64	2 190
xiv)	L 250 × 90 × 9 × 14	26.9	250	90	9	14	17	8.5	34.31	8.46	2 240
xv)	L 250 × 90 × 9 × 15	27.6	250	90	9	15	17	8.5	35.12	8.30	2 280
xvi)	L 250 × 90 × 10 × 15	29.4	250	90	10	15	17	8.5	37.47	8.61	2 440
xvii)	L 250 × 90 × 10.5 × 15	30.3	250	90	10.5	15	15	7.5	38.5	8.76	2 510
xviii)	L 250 × 90 × 11 × 16	31.9	250	90	11	16	17	8.5	40.61	8.74	2 640

Table 3 (Continued)

SI No.	Designation	Mass	Dimensions						Sectional Area	Centroid	Moment of Inertia I_{zz}
			H	B	t	T	R	r			
			kg/m	mm	mm	mm	mm	mm			
(1)	(2)	(3)	(4)	(5)	(6)	(7)	(8)	(9)	(10)	(11)	(12)
xix)	L 250 × 90 × 11.5 × 16	32.7	250	90	11.5	16	15	7.5	41.7	8.90	2 710
xx)	L 250 × 90 × 12 × 16	33.7	250	90	12	16	17	8.5	42.95	8.99	2 790
xxi)	L 275 × 100 × 10.5 × 14	32.8	275	100	10.5	14	15	7.5	41.8	9.72	3 330
xxii)	L 275 × 100 × 11.5 × 15	35.5	275	100	11.5	15	15	7.5	45.3	9.84	3 500
xxiii)	L 300 × 90 × 10 × 16	34.1	300	90	10	16	19	9.5	43.38	10.6	4 100
xxiv)	L 300 × 90 × 11 × 16	36.3	300	90	11	16	19	9.5	46.22	11.0	4 370
xxv)	L 300 × 90 × 12 × 17	39.1	300	90	12	17	19	9.5	49.84	11.1	4 690
xxvi)	L 300 × 90 × 13 × 17	41.3	300	90	13	17	19	9.5	52.67	11.3	4 940
xxvii)	L 300 × 100 × 10.5 × 15	35.6	300	100	10.5	15	15	7.5	45.3	10.6	4 290
xxviii)	L 300 × 100 × 11.5 × 16	38.5	300	100	11.5	16	15	7.5	49.0	10.7	4 630
xxix)	L 325 × 120 × 10.5 × 14	39.3	325	120	10.5	14	20	10	50.1	11.3	5 600
xxx)	L 325 × 120 × 11.5 × 15	42.6	325	120	11.5	15	20	10	54.3	11.4	6 060
xxxii)	L 350 × 100 × 11 × 17	42.7	350	100	11	17	22	11	54.41	12.7	7 030
xxxiii)	L 350 × 100 × 12 × 17	45.3	350	100	12	17	22	11	57.74	13.0	7 440
xxxiv)	L 350 × 120 × 11.5 × 18	47.4	350	120	11.5	18	20	10	60.4	12.0	7 780
xxxv)	L 375 × 120 × 10.5 × 18	46.9	375	120	10.5	18	20	10	59.7	12.7	8 850
xxxvi)	L 375 × 120 × 11.5 × 20	51.4	375	120	11.5	20	20	10	65.4	12.7	9 650

Table 3 (Concluded)

SI No.	Designation	Mass	Dimensions						Sectional Area	Centroid	Moment of Inertia I_{ZZ}
			H	B	t	T	R	r			
			kg/m	mm	mm	mm	mm	mm			
(1)	(2)	(3)	(4)	(5)	(6)	(7)	(8)	(9)	(10)	(11)	(12)
xxxvii)	L 400 × 100 × 11.5 × 16	47.9	400	100	11.5	16	24	12	61.09	15.3	10 300
xxxviii)	L 400 × 100 × 11.5 × 16	50.8	400	100	12	18	24	12	64.77	15.1	10 900
xxxix)	L 400 × 100 × 11.5 × 16	53.8	400	100	13	18	24	12	68.59	15.4	11 500
xl)	L 400 × 100 × 13 × 18	53.8	400	100	13	18	24	12	68.6	15.4	11 500
xli)	L 400 × 120 × 11.5 × 23	56.2	400	120	11.5	23	20	10	71.6	13.3	11 900
xlvi)	L 400 × 120 × 12.5 × 25	60.8	400	120	12.5	25	20	10	77.5	13.4	12 900
xlvi)	L 425 × 120 × 11.5 × 24	59.3	425	120	11.5	24	20	10	75.5	14.2	14 200
xlvi)	L 425 × 120 × 12.5 × 26	64.1	425	120	12.5	26	20	10	81.7	14.3	15 400
xlvi)	L 450 × 120 × 11.5 × 25	62.4	450	120	11.5	25	20	10	89.5	15.1	16 800
xlvi)	L 450 × 125 × 11.5 × 25	57.4	450	125	11.5	18	24	12	73.11	16.2	15 700
xlvi)	L 450 × 120 × 12.5 × 27	67.4	450	120	12.5	27	20	10	85.9	15.2	18 200
xlvi)	L 475 × 120 × 11.5 × 28	67.2	475	120	11.5	28	20	10	85.6	15.7	20 100
xlvi)	L 475 × 120 × 12.5 × 30	72.4	475	120	12.5	30	20	10	92.2	15.9	21 600
l)	L 500 × 120 × 11.5 × 30	71.2	450	120	11.5	30	20	10	90.7	16.4	23 600
li)	L 500 × 120 × 12.5 × 33	77.4	500	120	12.5	33	20	10	98.6	16.5	25 500
lii)	L 500 × 120 × 13.5 × 35	82.8	500	120	13.5	35	20	10	105	16.6	27 100

8 TOLERANCES

8.1 For Bulb Angles

The rolling and cutting tolerances for bulb angles shall be as stipulated in IS 1852.

8.2 For Bulb Flats

8.2.1 Width and Thickness

Tolerances on width and thickness shall be as given in [Table 4](#).

8.2.2 Radius at Corner

The radius of curvature r_2 at corners shall be within the limits given in [Table 5](#).

8.2.3 Straightness

The maximum permissible variation in straightness when measured over the entire length shall be $0.0035 \times \text{length}$.

8.2.4 Length

The cutting tolerance on length shall be $\pm \frac{+100}{-0}$ mm. The bulb flats may be supplied to tighter length tolerances subject to agreement between the purchaser and the supplier.

8.2.5 Weight

The tolerance on weight shall be ± 2.5 percent of the mass per unit length of sections given in [Table 2](#).

8.2.6 Flatness

8.2.6.1 The plate flatness tolerance, h is 0.3 percent of the bulb flat width b and is measured as shown in [Fig. 4](#).

8.2.6.2 The bulb flatness tolerance, n of the heel is measured as shown in [Fig. 5](#).

Table 4 Tolerances on Width and Thickness

(Clause [8.2.1](#))

SI No.	Width, b		Thickness, t		Tolerance on Width	Tolerance on Thickness	
	Over	Up to and Including	Including and Over	Up to and Including		Over	Under
	mm	mm	mm	mm	mm	mm	mm
(1)	(2)	(3)	(4)	(5)	(6)	(7)	(8)
i)	–	120	4.0	8.0	± 1.5	+ 0.7	- 0.3
ii)	120	180	7.0	11.0	± 2.0	+ 1.0	- 0.3
iii)	180	300	9.0	13.0	± 3.0	+ 1.0	- 0.4
iv)	300	430	12.0	20.0	± 4.0	+ 1.2	- 0.4

Table 5 Radius at Corner

(Clause [8.2.2](#))

SI No.	Thickness		Radius of Curvature (r_2), Max
	Over	Up to and Including	
	mm	mm	mm
(1)	(2)	(3)	(4)
i)	–	6	1.5
ii)	6	9	2.0
iii)	9	13	3.0
iv)	13	17	4.0

Plate flatness tolerance: $h \leq 0.003 \times b$

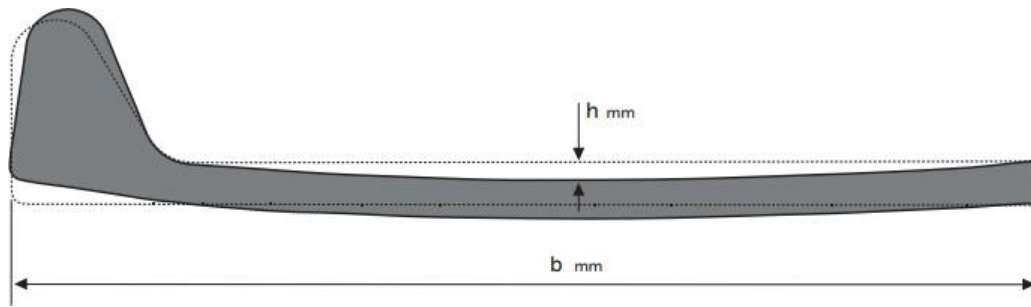

FIG. 4 PLATE FLATNESS TOLERANCE OF BULB FLAT

Bulb flatness tolerance: $n \leq 2.0$ mm



FIG. 5 BULB FLATNESS TOLERANCE OF BULB FLAT

8.3 For ‘L’ Section

8.3.1 Height of Web (H) and Width of Flange (B)

The tolerance on H and B shall be as given below:

Sl No.	H	Tolerance on H and B
	mm	mm
(1)	(2)	(3)
i)	Up to and including 200	± 3
ii)	Over 200	± 4

8.3.2 Web Thickness, t

The tolerance on the thickness of web shall be $\frac{+1.6}{-0.4}$ mm.

8.3.3 Flange Thickness, T

The tolerance on the thickness of flange leg T shall be as given in [Table 6](#).

Table 6 Tolerance on Thickness of Flange

(Clause [8.3.3](#))

Sl No.	Thickness, T		Tolerance	
	Over	Up to and Including	Over	Under
(1)	(2)	(3)	(4)	(5)
i)	–	20	+ 2.0	- 0.4
ii)	20	30	+ 2.0	- 0.5
iii)	30	35	+ 2.5	- 0.6

8.3.4 Straightness

The maximum permissible variation in straightness when measured over the entire length shall be $0.003 \times \text{length (L)}$, (see [Fig. 6](#)).

8.3.5 Out of Square

The legs shall be perpendicular to each other within a maximum deviation on 2.5 percent of B. The deviation shall be measured at the end of shorter leg (see [Fig. 7](#)).

8.3.6 Flatness

The tolerance on flatness of web shall be subject to agreement between the purchaser and the manufacturer. The deviation from flatness shall however be measured as shown in [Fig. 8](#).

sections may be supplied to tighter length tolerances subject to agreement between the purchaser and the supplier.

8.3.7 Length

The tolerance on length shall be $\frac{+100}{-0}$ mm. The angle

8.3.8 Mass

The tolerance on mass shall be ± 2.5 percent of the mass per unit length given in [Table 3](#).

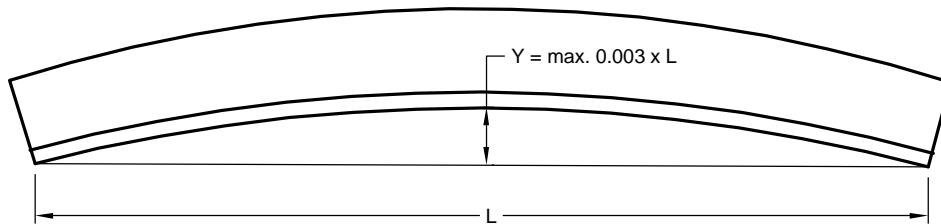

FIG. 6 MEASUREMENT OF STRAIGHTNESS

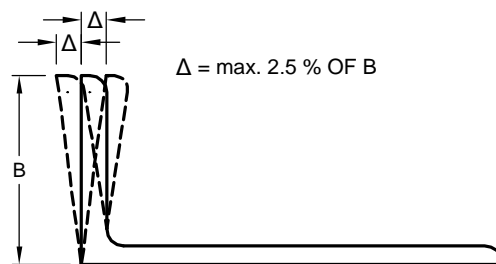

FIG. 7 MEASUREMENT OF OUT-OF-SQUARE

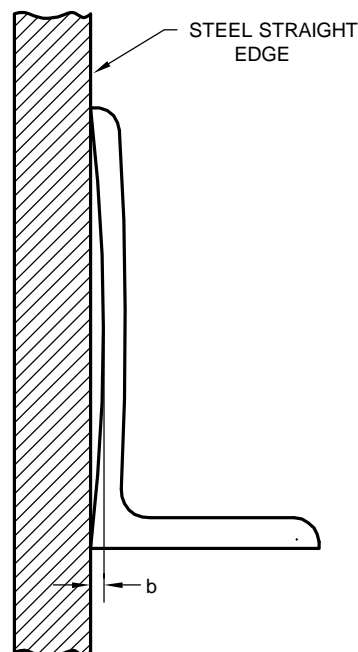

FIG. 8 MEASUREMENT OF DEVIATION IN FLATNESS OF WEB

ANNEX A

(Foreword)

COMMITTEE COMPOSITION

Structural Engineering Sectional Committee, CED 07

<i>Organization</i>	<i>Representative(s)</i>
In Personal Capacity (<i>II, 2A, Rani Meyyammai Towers MRC Nagar, R A Puram Chennai - 600028</i>)	DR V. KALYANARAMAN (Chairperson)
Ashwathnarayana & Eswara, Chennai	SHRI H. E. SRIPRAKASH SHASTRY
Bhilai Institute of Technology, Durg	DR MOHAN KUMAR GUPTA
Central Electricity Authority, New Delhi	SHRI A. K. JAIN DIRECTOR (TRANSMISSION) (<i>Alternate</i>)
Central Public Works Department, New Delhi	SHRI D. K. GARG SHRI N. K. BANSAL (<i>Alternate</i>)
Construma Consultancy Pvt Ltd, Mumbai	DR HARSHAVARDHAN SUBBARAO
C.R. Narayana Rao, Architects & Engineers, Chennai	DR C. N. SRINIVASAN SHRI C. R. ARVIND (<i>Alternate</i>)
CSIR - Structural Engineering Research Centre, Chennai	DR G. S. PALANI DR NAPA PRASAD RAO (<i>Alternate I</i>) DR R. BALAGOPAL (<i>Alternate II</i>)
Engineers India Ltd, New Delhi	SHRI ANURAG SINHA DR SUDIP PAUL (<i>Alternate</i>)
GAIL India Ltd, New Delhi	SHRI S. ASHISH VAIDYA
Indian Institute of Engineering Science and Technology, Shibpur	DR SUBRATA CHACKRABORTY MS CHAITALI RAY (<i>Alternate</i>)
Indian Institute of Technology Delhi, New Delhi	DR DIPTI RANJAN SAHOO DR ALOK MADAN (<i>Alternate</i>)
Institute for Steel Development & Growth, Kolkata	SHRI ARIJIT GUHA SHRI LAKHAMANA RAO PYDI (<i>Alternate</i>)
Jindal Steel & Power Ltd, Gurugram	SHRI SANJAY NANDANWAR
Larsen & Toubro Ltd, Chennai	SHRI T. VENKATESH RAO
MECON Ltd, Ranchi	SHRI B. K. PANDEY SHRI J. K. SARKAR (<i>Alternate</i>)
M. N. Dastur & Company Pvt Ltd, Kolkata	SHRI SHUVENDU CHATTOPADHYAY SHRI GARGI ADITYA BASU (<i>Alternate I</i>) SHRIMATI MOHUA CHATTERJEE (<i>Alternate II</i>)
NTPC Ltd, Noida	SHRI HIMANSHU KUNDU SHRI CHANDER SHEKHAR (<i>Alternate</i>)

<i>Organization</i>	<i>Representative(s)</i>
Powergrid Corporation of India Limited, New Delhi	SHRI ABHISHEK MS SUMANA MUKHERJEE (<i>Alternate</i>)
Ramboll India, Hyderabad	SHRI D. SANKAR GANESH
Salasar Techno Engineering Ltd, Noida	SHRI DAYANAND K.
Steel Authority of India Limited, Ranchi	SHRI GAUTAM KUMAR MITRA SHRI DEEPAK RANGARAO (<i>Alternate</i>)
STUP Consultants Pvt Ltd, Kolkata	SHRI ANIRBAN SENGUPTA SHRI SUMANTRA SENGUPTA (<i>Alternate I</i>) SHRI MANDAR SARDESAI (<i>Alternate II</i>)
Takalkar Power Engineering and Consultants Pvt Ltd, Vadodara	SHRI S. M. TAKALKAR SHRI SHREEDHAR V. RANA (<i>Alternate</i>)
Tata Consulting Engineers Ltd, Mumbai	SHRI PRATIP BHATTACHARYA SHRI T. SHRIPRASAD (<i>Alternate</i>)
The Institution of Engineers (India), Kolkata	SHRI S. H. JAIN
In Personal Capacity (C-401, Greenfield Tower CHS, Kadamwadi, Vakola Santacruz (East), Mumbai)	SHRI V. N. HEGGADE
In Personal Capacity (Plot No. 686/2884, Shantinagar, Canal Road, Jharapada, Bhubaneswar - 751006)	SHRI GAYANA RANJAN MOHAINTY
BIS Directorate General	SHRI DWAIPAYAN BHADRA, SCIENTIST 'E'/DIRECTOR AND HEAD (CIVIL ENGINEERING) [REPRESENTING DIRECTOR GENERAL (<i>Ex-officio</i>)]

Member Secretaries

SHRI ABHISHEK PAL
SCIENTIST 'D'/JOINT DIRECTOR

AND

SHRI DHEERAJ DAMACHYA
SCIENTIST 'B'/ASSISTANT DIRECTOR
(CIVIL ENGINEERING), BIS

Bureau of Indian Standards

BIS is a statutory institution established under the *Bureau of Indian Standards Act, 2016* to promote harmonious development of the activities of standardization, marking and quality certification of goods and attending to connected matters in the country.

Copyright

BIS has the copyright of all its publications. No part of these publications may be reproduced in any form without the prior permission in writing of BIS. This does not preclude the free use, in the course of implementing the standard, of necessary details, such as symbols and sizes, type or grade designations. Enquiries relating to copyright be addressed to the Head (Publication & Sales), BIS.

Review of Indian Standards

Amendments are issued to standards as the need arises on the basis of comments. Standards are also reviewed periodically; a standard along with amendments is reaffirmed when such review indicates that no changes are needed; if the review indicates that changes are needed, it is taken up for revision. Users of Indian Standards should ascertain that they are in possession of the latest amendments or edition by referring to the website-www.bis.gov.in or www.standardsbis.in.

This Indian Standard has been developed from Doc No.: **FAD 07** (22217).

Amendments Issued Since Publication

Amend No.	Date of Issue	Text Affected

BUREAU OF INDIAN STANDARDS

Headquarters:

Manak Bhavan, 9 Bahadur Shah Zafar Marg, New Delhi 110002

Telephones: 2323 0131, 2323 3375, 2323 9402

Website: www.bis.gov.in

Regional Offices:

	Telephones
Central : 601/A, Konnectus Tower -1, 6 th Floor, DMRC Building, Bhavbhuti Marg, New Delhi 110002	{ 2323 7617
Eastern : 8 th Floor, Plot No 7/7 & 7/8, CP Block, Sector V, Salt Lake, Kolkata, West Bengal 700091	{ 2367 0012 2320 9474
Northern : Plot No. 4-A, Sector 27-B, Madhya Marg, Chandigarh 160019	{ 265 9930
Southern : C.I.T. Campus, IV Cross Road, Taramani, Chennai 600113	{ 2254 1442 2254 1216
Western : 5 th Floor/MTNL CETTM Technology Street, Hiranandani Gardens, Powai, Mumbai - 400076	{ 25700030 25702715

Branches : AHMEDABAD, BENGALURU, BHOPAL, BHUBANESHWAR, CHANDIGARH, CHENNAI, COIMBATORE, DEHRADUN, DELHI, FARIDABAD, GHAZIABAD, GUWAHATI, HARYANA (CHANDIGARH), HUBLI, HYDERABAD, JAIPUR, JAMMU, JAMSHEDPUR, KOCHI, KOLKATA, LUCKNOW, MADURAI, MUMBAI, NAGPUR, NOIDA, PARWANOO, PATNA, PUNE, RAIPUR, RAJKOT, SURAT, VIJAYAWADA.