

औजार इस्पात — विशिष्टि  
( तीसरा पुनरीक्षण )

Tool Steels — Specification  
( Third Revision )

ICS 77.140.35

© BIS 2022



भारतीय मानक ब्यूरो  
BUREAU OF INDIAN STANDARDS  
मानक भवन, 9 बहादुर शाह ज़फर मार्ग, नई दिल्ली - 110002  
MANAK BHAVAN, 9 BAHADUR SHAH ZAFAR MARG  
NEW DELHI - 110002

[www.bis.gov.in](http://www.bis.gov.in) [www.standardsbis.in](http://www.standardsbis.in)



## NATIONAL FOREWORD

This Indian standard (Third Revision) which is identical with ISO 4957 : 2018 'Tool steels' issued by the International Organization for Standardization (ISO), and subject to its finalization, is to be adopted by the Bureau of Indian Standards on the recommendation of the Alloy Steels and Forging Sectional Committee and approval of the Metallurgical Engineering Division Council.

This standard was first published in 1966 and subsequently revised in 1978 and 1990. While reviewing this standard, the Committee felt necessary to align it with latest international developments in this field. Accordingly, it has been decided to harmonize IS 3748 with the latest version of ISO 4957 : 2018 'Tool Steels', which specifies requirements for tool steels comprising of non-alloy cold-work tool steels, alloy cold-work tool steels, alloy hot-work tool steels and high speed tool steels. This revision of IS 3748 replaces IS 3748 : 1990 'Tool and Die Steels' and IS 7291 : 1981 'High Speed Tool Steels'. IS 7291 shall stand withdrawn subsequently.

The text of ISO standard has been approved as suitable for publication as in Indian Standard without deviations. Certain terminologies and conventions are, however, not identical with those used in Indian Standard. Attention is especially drawn to the following:

- a) Wherever the words 'International Standard' appear referring to this standard, it should be read as 'Indian Standard'
- b) Comma (,) has been used as a decimal marker while in Indian Standards the current practice is to use a point (.) as the decimal marker.

In this adopted standard, reference appears to certain International Standards for which Indian Standards also exists. The corresponding Indian Standards which are to be substituted in their place are listed below along with their degree of equivalence for the edition indicated:

<i>International Standard</i>	<i>Corresponding Indian Standard</i>	<i>Degree of Equivalence</i>
ISO 377 : 2017 Steel and steel products — Location and preparation of samples and test pieces for mechanical testing	IS 3711 : 2020/ISO 377 : 2017 Steel and Steel Products — Location and Preparation of Samples and Test Pieces for Mechanical Testing ( <i>third revision</i> )	Identical
ISO 404 : 2013 Steel and steel products — General technical delivery requirements	IS 8910 : 2022/ISO 404 : 2013 Steel and steel products — General technical delivery requirements ( <i>second revision</i> )	Identical
ISO 1035-3 : 1980 Hot-rolled steel bars — Part 3: Dimensions of flat bars	IS 1730 : 1989 Dimensions for steel plates, sheets strips and flats for general engineering purposes	Not Equivalent
ISO 4948-1 : 1982 Steels — Classification — Part 1: Classification of steels into unalloyed and alloy steels based on chemical composition	IS 7598 : 1990 Classification of steels ( <i>first revision</i> )	Not Equivalent

<i>International Standard</i>	<i>Corresponding Indian Standard</i>	<i>Degree of Equivalence</i>
ISO 6506-1 : 2014 Metallic materials — Brinell hardness test — Part 1: Test method	IS 1500 (Part 1) : 2019/ISO 6506-1 : 2014 Metallic materials - Brinell hardness test: Part 1 test method ( <i>fifth revision</i> )	Identical
ISO 6508-1 : 2016 Metallic materials — Rockwell hardness test — Part 1: Test method	IS 1586 (Part 1) : 2018 Metallic materials - Rockwell hardness test: Part 1 test method ( <i>fifth revision</i> )	Identical
ISO 7452 : 2013 Hot rolled steel plates — Tolerances on dimensions and shape	IS 16998 : 2018/ISO 7452 : 2013 Hot - Rolled steel plates - Tolerances on dimensions and shape	Identical
ISO 7788 : 1985 Steel — Surface finish of hot-rolled plates and wide flats — Delivery requirements	IS 12457 : 1988 Code of practice for evaluation, repairs and acceptance limits of surface defects in steel plates and wide flats	Not Equivalent
ISO/TR 9769 : 1991 Steel and iron — Review of available methods of analysis	SP 71 : 2012 Compendium of Method of Chemical Analysis Of Steels	Not Equivalent
ISO 10474 : 2013 Steel and steel products — Inspection documents	IS 10474 : 2013 Steel and steel products - Inspection documents	Identical
ISO 14284 : 1996 Steel and iron — Sampling and preparation of samples for the determination of chemical composition	IS/ISO 14284 : 1996 Steel and iron - Sampling and preparation of samples for the determination of chemical composition	Identical
ISO 17577 : 2016 Steel — Ultrasonic testing of steel flat products of thickness equal to or greater than 6 mm	IS 4225 : 2021/ISO 17577 : 2016 Steel — Ultrasonic testing of steel flat products of thickness equal to or greater than 6 mm ( <i>third revision</i> )	Identical

The technical committee responsible for the preparation of this standard has reviewed the provisions of following International Standard referred in this adopted standard and has decided that it is acceptable for use in conjunction with this standard:

<i>International Standard</i>	<i>Title</i>
ISO 1035-1	Hot-rolled steel bars — Part 1: Dimensions of round bars
ISO 1035-4	Hot-rolled steel bars — Part 4: Tolerances
ISO 4885	Ferrous materials — Heat treatments — Vocabulary
ISO/TS 4949	Steel names based on letter symbols
ISO 6929	Steel products — Vocabulary
ISO 9443	Surface quality classes for hot-rolled bars and wire rod

This standard also makes a reference to the BIS Certification Marking of the product, details of which are given in National Annex A.

For the purpose of deciding whether a particular requirement of this standard is complied with, the final value, observed or calculated, expressing the result of a test or analysis shall be rounded off in accordance with IS 2 : 2022 'Rules for rounding off numerical values (*second revision*)'. The number of significant places retained in the rounded off value should be the same as that of the specified value in this standard.



# Contents

Page

<b>1</b>	<b>Scope</b> .....	<b>1</b>
<b>2</b>	<b>Normative references</b> .....	<b>1</b>
<b>3</b>	<b>Terms and definitions</b> .....	<b>2</b>
<b>4</b>	<b>Classification and designation</b> .....	<b>2</b>
4.1	Classification .....	2
4.2	Designation .....	2
<b>5</b>	<b>Information to be supplied by the purchaser</b> .....	<b>3</b>
5.1	Mandatory information .....	3
5.2	Options .....	3
5.3	Ordering example .....	3
<b>6</b>	<b>Manufacturing process</b> .....	<b>3</b>
6.1	General .....	3
6.2	Heat-treatment condition and surface condition on delivery .....	4
6.2.1	General .....	4
6.2.2	Heat-treatment condition .....	4
6.2.3	Surface condition .....	4
<b>7</b>	<b>Requirements</b> .....	<b>4</b>
7.1	General requirements .....	4
7.2	Chemical composition and mechanical properties .....	4
7.3	Surface quality .....	4
7.4	Shape, dimensions and tolerances .....	5
<b>8</b>	<b>Inspection, testing and conformance of products</b> .....	<b>5</b>
8.1	Inspection and testing procedures and types of inspection documents .....	5
8.2	Specific inspection and testing .....	6
8.2.1	Number of sample products .....	6
8.2.2	Sampling .....	6
8.2.3	Test methods .....	6
8.2.4	Retests .....	6
8.2.5	Sorting and reprocessing .....	7
<b>9</b>	<b>Marking</b> .....	<b>7</b>
<b>10</b>	<b>Tables</b> .....	<b>7</b>
<b>11</b>	<b>Location of test pieces in the hardening test</b> .....	<b>17</b>
11.1	Product diameter or thickness $\geq 15$ mm .....	17
11.2	Product diameter or thickness $< 15$ mm .....	18
<b>Annex A (informative) Hardness-tempering temperature curves</b> .....		<b>19</b>
<b>Annex B (normative) Supplementary or special requirements</b> .....		<b>29</b>
<b>Annex C (informative) Designations of comparable steels</b> .....		<b>31</b>
<b>Bibliography</b> .....		<b>33</b>





*Indian Standard*  
**TOOL STEELS – SPECIFICATION**  
( *Third Revision* )

## **1 Scope**

This document specifies requirements for the following grades of wrought tool steels:

- a) non-alloy cold-work tool steels;
- b) alloy cold-work tool steels;
- c) alloy hot-work tool steels;
- d) high-speed tool steels.

If not stated otherwise, this document applies to all types of hot-rolled, forged, cold-drawn or cold-rolled products or products produced by powder metallurgy, which are supplied in one of the surface and heat-treatment conditions given in [6.2](#) and [Table 1](#).

NOTE [Tables 2, 4, 6](#) and [8](#) cover only those steels which have gained certain international importance, which does not mean, however, that they are available in all industrial countries. In addition, a number of other steels for tools are specified in regional, national or company standards.

Where the heat resistance of the tools is of particular importance, as for example in the case of tools for hot forming glass, the material selection is based on ISO 4955.

## **2 Normative references**

The following documents are referred to in the text in such a way that some or all of their content constitutes requirements of this document. For dated references, only the edition cited applies. For undated references, the latest edition of the referenced document (including any amendments) applies.

ISO 377, *Steel and steel products — Location and preparation of samples and test pieces for mechanical testing*

ISO 404, *Steel and steel products — General technical delivery requirements*

ISO 1035-1, *Hot-rolled steel bars — Part 1: Dimensions of round bars*

ISO 1035-3, *Hot-rolled steel bars — Part 3: Dimensions of flat bars*

ISO 1035-4:1982, *Hot-rolled steel bars — Part 4: Tolerances*

ISO 4885, *Ferrous materials — Heat treatments — Vocabulary*

ISO 4948-1, *Steels — Classification — Part 1: Classification of steels into unalloyed and alloy steels based on chemical composition*

ISO/TS 4949, *Steel names based on letter symbols*

ISO 6506-1, *Metallic materials — Brinell hardness test — Part 1: Test method*

ISO 6508-1, *Metallic materials — Rockwell hardness test — Part 1: Test method*

ISO 6929, *Steel products — Vocabulary*

ISO 7452:2013, *Hot rolled steel plates — Tolerances on dimensions and shape*

ISO 7788, *Steel — Surface finish of hot-rolled plates and wide flats — Delivery requirements*

ISO 9443, *Surface quality classes for hot-rolled bars and wire rod*

ISO/TR 9769, *Steel and iron — Review of available methods of analysis*

ISO 10474, *Steel and steel products — Inspection documents*

ISO 14284, *Steel and iron — Sampling and preparation of samples for the determination of chemical composition*

ISO 17577, *Steel — Ultrasonic testing of steel flat products of thickness equal to or greater than 6 mm*

### **3 Terms and definitions**

For the purposes of this document, the terms and definitions given in ISO 4885, ISO 4948-1 and ISO 6929 and the following apply.

ISO and IEC maintain terminological databases for use in standardization at the following addresses:

- ISO Online browsing platform: available at <https://www.iso.org/obp>
- IEC Electropedia: available at <http://www.electropedia.org/>

#### **3.1**

##### **tool steel**

special steel suitable for working or processing of materials, for handling and measuring workpieces and, for this purpose, exhibiting high hardness and wear resistance and/or toughness

#### **3.2**

##### **cold-work tool steel**

non-alloy or alloy *tool steel* (3.1) for applications in which the surface temperature is generally below 200 °C

#### **3.3**

##### **hot-work tool steel**

alloy *tool steel* (3.1) for applications in which the surface temperature is generally over 200 °C

#### **3.4**

##### **high-speed tool steel**

steel used mainly for machining and for forming processes and which, because of the chemical composition, has the highest high-temperature hardness and temper resistance up to about 600 °C

### **4 Classification and designation**

#### **4.1 Classification**

The classification of the relevant steel grades shall be in accordance with ISO 4948-1.

#### **4.2 Designation**

For the steel grades covered by this document, the steel names, as given in the relevant tables, shall be allocated in accordance with ISO/TS 4949.

For information on designation of comparable steels, see [Annex C](#).

## 5 Information to be supplied by the purchaser

### 5.1 Mandatory information

The manufacturer shall obtain the following information from the purchaser at the time of enquiry and order:

- a) the quantity to be delivered;
- b) the product form (e.g. round bar);
- c) either the dimensional standard and the dimensions and tolerances selected from it (see [7.4](#)) or any other document covering the dimensions and tolerances required for the product;
- d) the reference to this document, i.e. ISO 4957;
- e) the designation of the steel type (see [Tables 2, 4, 6 and 8](#));
- f) the symbol for the heat-treatment condition on delivery (see [Table 1](#)) and, if the products are to be delivered in the quenched and tempered condition, the hardness values required;
- g) the type of inspection document in accordance with ISO 10474.

### 5.2 Options

A number of options are specified in this document and listed below. If the purchaser does not indicate the wish to implement any of these options, the products shall be supplied in accordance with the basic specifications of this document (see [5.1](#)):

- a) if a surface condition other than “hot worked” or a special surface quality is required, the surface condition (see [6.2.3](#)) and the surface quality (see [7.3](#));
- b) any supplementary requirement that shall be complied with, the symbol and, where necessary, the details of this supplementary requirement (in accordance with [Annex B](#)).

### 5.3 Ordering example

EXAMPLE 2 t hot-rolled round bars in accordance with ISO 1035-1; with a nominal diameter of 30,0 mm; with a nominal length of 4 000 mm; with a tolerance on diameter of  $\pm 0,30$  mm (class S of ISO 1035-4:1982); with a tolerance on length of +10 mm (class L2 of ISO 1035-4:1982); all other tolerances as given in ISO 1035-4 for normal cases, surface as hot worked made of steel grade in accordance with this document, type X153CrMoV12 (see [Table 4](#)); heat-treatment condition: annealed (soft annealed) (symbol +A, see [Table 1](#)); with an inspection certificate 3.1 (see ISO 10474).

**2 t rounds ISO 1035-1 and -4 - 30,0 S x 4000 L2**

**Steel ISO 4957-X153CrMoV12+A**

**ISO 10474 - 3.1**

## 6 Manufacturing process

### 6.1 General

The manufacturing process of the steel and the products is left to the discretion of the manufacturer, with the restrictions given in [6.2](#). Upon request, the purchaser shall be informed what steel making process is being used.

## 6.2 Heat-treatment condition and surface condition on delivery

### 6.2.1 General

The heat-treatment and surface conditions of the products shall comply with the agreements made at the time of ordering.

### 6.2.2 Heat-treatment condition

The heat-treatment conditions are given in [Table 1](#).

Unless otherwise specified in the order, the tool steels [except C45U ([Table 2](#)), 35CrMo7, X38CrMo16 and 40CrMnNiMo8-6-4 ([Table 4](#)), 55NiCrMoV7 ([Table 6](#))] are delivered in the annealed condition.

### 6.2.3 Surface condition

Usual surface conditions are

- a) the hot-rolled or forged condition (= as hot worked),
- b) the machined (ground, polished, turned, peeled or milled) condition, and
- c) the cold-reduced condition.

Unless otherwise agreed at the time of enquiry and order, the products shall be delivered in the surface condition hot worked.

## 7 Requirements

### 7.1 General requirements

In addition to this document, the general technical delivery requirements of ISO 404 apply.

### 7.2 Chemical composition and mechanical properties

[Table 1](#) gives a survey of combinations of usual heat-treatment conditions at delivery and requirements according to [Tables 2](#) to [9](#) (chemical composition, hardness).

For hardness-tempering temperature curves of the steels, see [Annex A](#).

For hardness penetration depth of non-alloy cold-work tool steels, see [Table 2](#), footnote c.

### 7.3 Surface quality

**7.3.1** All products shall have a smooth surface finish appropriate to the manufacturing processes applied. Minor surface imperfections, which also may occur under normal manufacturing conditions, such as prints originating from rolled-in scale, are not to be regarded as defects.

Bars shall be delivered with surface class A in accordance with ISO 9443 unless otherwise agreed at the time of enquiry and order. Plates shall be delivered in accordance with ISO 7788 unless otherwise agreed at the time of enquiry and order.

**7.3.2** Ground, polished or finished-machined products shall be free from surface imperfections and surface decarburization.

**7.3.3** Hot-rolled, forged, cold-drawn or rough-machined products shall be ordered with sufficient material to be removed from all surfaces by machining or grinding to allow for

- a) surface decarburization, and
- b) surface imperfections.

Providing no International Standard for the machining allowances of tool steels is available, the allowances shall be agreed at the time of enquiry and order.

## **7.4 Shape, dimensions and tolerances**

The shape, dimensions and tolerances of the products shall comply with the requirements agreed upon at the time of enquiry and order. The agreements shall, as far as possible, be based on corresponding International Standards or, otherwise, on suitable national standards.

For rolled flat and round bars, the following International Standards that cover dimensions and/or tolerances for products included in this document shall apply: ISO 1035-1, ISO 1035-3 and ISO 1035-4.

For hot rolled plates ISO 7452:2013, Annex A class A shall apply if not otherwise agreed.

NOTE By agreement, the tolerances can be all plus or other disposition than equal plus/minus.

## **8 Inspection, testing and conformance of products**

### **8.1 Inspection and testing procedures and types of inspection documents**

**8.1.1** Products complying with this document shall be ordered and delivered with one of the inspection documents as specified in ISO 10474. The type of document shall be agreed upon at the time of enquiry and order. If the order does not contain any specification of this type, a test report 2.2 shall be issued.

**8.1.2** If, in accordance with the agreements made at the time of enquiry and order, a test report 2.2 is to be provided, this shall cover

- a) the statement that the material complies with the requirements of the order, and
- b) the results of the cast analysis for all elements specified for the type of steel supplied.

**8.1.3** If, in accordance with the agreements in the order, an inspection certificate 3.1 or 3.2 is to be provided, the specific inspections and tests described in [8.2](#) shall be carried out and their results shall be certified in the document.

In addition the document shall cover

- a) the results of the cast analysis provided by the manufacturer for all elements specified for the steel type concerned,
- b) the results of all inspections and tests ordered by supplementary requirements (in accordance with [Annex B](#)), and
- c) the symbol letters of numbers connecting the inspection documents, the test pieces and products to each other.

## 8.2 Specific inspection and testing

### 8.2.1 Number of sample products

#### 8.2.1.1 Chemical composition

The cast analysis is given by the manufacturer. For product analysis, see [B.2](#).

#### 8.2.1.2 Mechanical properties

**8.2.1.2.1** One sample product per test unit shall be tested.

**8.2.1.2.2** For material delivered in the annealed or annealed and cold rolled or annealed and cold drawn condition, the test unit shall consist of products from the same cast and the same heat-treatment batch.

In the case of material heat treated in a continuous furnace, a heat-treatment batch is regarded as the quantity of products (of the same cast and dimensions) that, without any interruptions, underwent constant treatment conditions (same furnace temperature, atmosphere and transportation speed) through the furnace.

**8.2.1.2.3** For material delivered in the quenched and tempered condition, the test unit shall consist of products from the same cast, heat-treatment and thickness.

However, if the manufacturer verifies that the thickness has no significant effect on the hardness in the quenched and tempered condition, then different thicknesses may be covered in a test unit.

In the case of material heat treated in a continuous furnace, a heat-treatment batch is regarded as the quantity of products (of the same cast and dimensions) that, without any interruptions, underwent constant treatment conditions (same furnace temperature, atmosphere and transportation speed) through the furnace.

#### 8.2.1.3 Inspection of the surface quality

Unless otherwise agreed when ordering (see [B.5](#)), the number of products to be inspected for surface quality is left to the discretion of the manufacturer.

#### 8.2.1.4 Dimensional inspection

Unless otherwise agreed when ordering (see [B.6](#)), the number of products to be inspected for their shape and dimensions is left to the discretion of the manufacturer.

### 8.2.2 Sampling

The general conditions for selection and preparation of samples and test pieces shall be in accordance with ISO 377 and ISO 14284.

For the Brinell hardness test, the surface of the sample product or of a test piece taken from the sample product in the delivery condition shall be prepared in accordance with the requirements of ISO 6506-1.

### 8.2.3 Test methods

The Brinell hardness test shall be made in accordance with ISO 6506-1.

Unless otherwise agreed (see [B.5](#)), the surface quality shall be inspected visually.

### 8.2.4 Retests

For retests, ISO 404 shall apply.

### **8.2.5 Sorting and reprocessing**

For sorting and reprocessing, ISO 404 shall apply.

## **9 Marking**

The manufacturer shall mark the products or the bundles or boxes containing the products in a suitable way, so that the identification of the cast, the steel type and the origin of the delivery is possible (see [B.9](#)).

## **10 Tables**

Table 1 — Combinations of heat-treatment conditions at delivery and requirements in accordance with Tables 2 to 9

1		2		3													
Heat-treatment condition at delivery		Symbol <sup>a</sup>		Applicable requirements for													
		3.1 non-alloy cold-work tool steels				3.2 alloy cold-work tool steels				3.3 hot-work tool steels				3.4 high-speed tool steels			
		Chemical composition acc. to Tables 2 and 3		Hardness acc. to Table 2		Chemical composition acc. to Tables 4 and 5		Hardness acc. to Table 4		Chemical composition acc. to Tables 6 and 7		Hardness acc. to Table 6		Chemical composition acc. to Tables 8 and 9		Hardness acc. to Table 8	
2	Untreated	+U	—c	—c	—c	—c	—c	—c	—c	—c	—c	—c	—c	—c	—c	—c	—c
3	Annealed (soft annealed) <sup>b</sup>	+Ab	+Ac	+Ac	+Ac	+Ac	+Ac	+Ac	+Ac	+Ac	+Ac	+Ac	+Ac	+Ac	+Ac	+Ac	+Ac
4	Annealed and cold drawn	+A+C	+A and footnote a to Table 2 <sup>c</sup>	+A and footnote b to Table 4 <sup>c</sup>	+A and footnote b to Table 4 <sup>c</sup>	+A and footnote b to Table 4 <sup>c</sup>	+A and footnote b to Table 4 <sup>c</sup>	+A and footnote b to Table 4 <sup>c</sup>	+A and footnote b to Table 4 <sup>c</sup>	+A and footnote b to Table 4 <sup>c</sup>	+A and footnote b to Table 4 <sup>c</sup>	+A and footnote b to Table 4 <sup>c</sup>	+A and footnote b to Table 4 <sup>c</sup>	+A and footnote b to Table 4 <sup>c</sup>	+A and footnote b to Table 4 <sup>c</sup>	+A and footnote b to Table 4 <sup>c</sup>	+A and footnote b to Table 4 <sup>c</sup>
5	Annealed and cold-rolled <sup>d</sup>	+A+CR <sup>d</sup>															
5	Quenched and tempered <sup>e</sup>	+QT <sup>e</sup>															
6	Normalized and tempered	+NT															

a In cases where no heat-treatment condition is specified at the time of ordering, the product will be delivered in the usual heat-treatment condition given in 6.2.2.

b Most common heat-treatment condition at delivery.

c In addition, the requirements for minimum hardness in the hardening test apply. For verification, see B.3.

d Only for steels of Table 8.

e Mainly for individually manufactured blocks for moulds and dies.

f The hardness requirements are to be agreed at the time of enquiry and order.

g Normalizing is performed either by normalizing in furnace or by normalizing forming.



**Table 2 — Chemical composition (cast analysis) for non-alloy cold-work tool steels, annealed hardness, austenitizing temperature and hardness in the hardened and tempered condition**

Steel name	Mass fraction, %						Hardness (annealed) <sup>a</sup> +A HBW max.	Hardening test			
	C	Si	Mn	P max.	S max.			Austenitizing temperature °C (±10 °C)	Quenching medium	Tempering temperature °C (±10 °C)	Hardness HRC min.
C45U <sup>b</sup>	0,42 to 0,50	0,15 to 0,40	0,60 to 0,80	0,030	0,030	0,030	207 <sup>b</sup>	W	180	54	
C70U <sup>c</sup>	0,65 to 0,75	0,10 to 0,30	0,10 to 0,40	0,030	0,030	0,030	183	W	180	57	
C80U <sup>c</sup>	0,75 to 0,85	0,10 to 0,30	0,10 to 0,40	0,030	0,030	0,030	192	W	180	58	
C90U <sup>c</sup>	0,85 to 0,95	0,10 to 0,30	0,10 to 0,40	0,030	0,030	0,030	207	W	180	60	
C105U <sup>c</sup>	1,00 to 1,10	0,10 to 0,30	0,10 to 0,40	0,030	0,030	0,030	212	W	180	61	
C120U <sup>c</sup>	1,15 to 1,25	0,10 to 0,30	0,10 to 0,40	0,030	0,030	0,030	217	W	180	62	

Elements not quoted in this table shall not be intentionally added to the steel without the agreement of the purchaser, other than for the purpose of finishing the heat. All reasonable precautions shall be taken to prevent the addition from scrap or other materials used in manufacture, of such elements which affect the hardenability, mechanical properties and applicability.

<sup>a</sup> Hardness in the cold drawn condition (+A+C) may be 20 HBW higher than in the annealed (+A) condition.

<sup>b</sup> This grade is used in the non-heat treated condition.

<sup>c</sup> Steel grades C70U to C120U are due to their chemical composition shallow hardening steels. For diameters of 30 mm, the hardness penetration depth will be approximately 3 mm. Through hardening may only be achieved in diameters up to 10 mm.

Table 3 — Permissible deviations between specified cast analysis and product analysis for non-alloy cold-work tool steels (see Table 2)

Permissible deviations, mass fraction %				
C	Si	Mn	P	S
±0,03	±0,03	±0,04	+0,005	+0,005

NOTE The deviations, other than when maxima only are specified, apply either *above* or below the specified limits of the range but not both *above* and below for the same element from different sample products from the same cast. When maxima only are specified, the deviations are positive only. The values are *valid* only if the samples are selected in accordance with ISO 14284, so that they represent the *average* composition of the cross-section of the product.

**Table 4 — Chemical composition (cast analysis) for alloy cold-work tool steels, annealed hardness, austenitizing temperature and hardness in the hardened and tempered condition**

Steel name	Mass fraction <sup>a</sup> , %										Hardness (annealed) <sup>b</sup> +A HBW max.	Hardening test				
	C	Si	Mn	Cr	Mo	Ni	V	W	Austenitizing temperature °C (±10 °C)	Quenching medium <sup>c</sup>		Tempering temperature °C (±10 °C)	Hardness HRC min.			
105V	1,00 to 1,10	0,10 to 0,30	0,10 to 0,40	—	—	—	—	—	—	—	—	212	790	W	180	61
50WCrV8	0,45 to 0,55	0,70 to 1,00	0,15 to 0,45	0,90 to 1,20	—	—	—	—	—	—	—	229	920	0	180	56
60WCrV8	0,55 to 0,65	0,70 to 1,00	0,15 to 0,45	0,90 to 1,20	—	—	—	—	—	—	—	229	910	0	180	58
102Cr6	0,95 to 1,10	0,15 to 0,35	0,25 to 0,45	1,35 to 1,65	—	—	—	—	—	—	—	223	840	0	180	60
21MnCr5	0,18 to 0,24	0,15 to 0,35	1,10 to 1,40	1,00 to 1,30	—	—	—	—	—	—	—	217	— <sup>d</sup>	— <sup>d</sup>	— <sup>d</sup>	— <sup>d</sup>
70MnMoCr8	0,65 to 0,75	0,10 to 0,50	1,80 to 2,50	0,90 to 1,20	0,90 to 1,40	—	—	—	—	—	—	248	835	A	180	58
90MnCrV8	0,85 to 0,95	0,10 to 0,40	1,80 to 2,20	0,20 to 0,50	—	—	—	—	—	—	—	229	790	0	180	60
95MnWCr5	0,90 to 1,00	0,10 to 0,40	1,05 to 1,35	0,40 to 0,65	—	—	—	—	—	—	—	229	800	0	180	60
X100CrMoV5	0,95 to 1,05	0,10 to 0,40	0,40 to 0,80	4,8 to 5,5	0,90 to 1,20	—	—	—	—	—	—	241	970	A	180	60
X153CrMoV12	1,45 to 1,60	0,10 to 0,60	0,20 to 0,60	11,0 to 13,0	0,70 to 1,00	—	—	—	—	—	—	255	1 020	A	180	61
X210Cr12	1,90 to 2,20	0,10 to 0,60	0,20 to 0,60	11,0 to 13,0	—	—	—	—	—	—	—	248	970	0	180	62
X210CrW12	2,00 to 2,30	0,10 to 0,40	0,30 to 0,60	11,0 to 13,0	—	—	—	—	—	—	—	255	970	0	180	62
35CrMo7e	0,30 to 0,40	0,30 to 0,70	0,60 to 1,00	1,50 to 2,00	0,35 to 0,55	—	—	—	—	—	—	— <sup>e</sup>	—	—	—	— <sup>e</sup>
40CrMnNiMo8-6-4e,f	0,35 to 0,45	0,20 to 0,40	1,30 to 1,60	1,80 to 2,10	0,15 to 0,25	0,90 to 1,20 <sup>f</sup>	—	—	—	—	—	— <sup>e</sup>	—	—	—	— <sup>e</sup>
45NiCrMo16	0,40 to 0,50	0,10 to 0,40	0,20 to 0,50	1,20 to 1,50	0,15 to 0,35	3,80 to 4,30	—	—	—	—	—	285	850	0	180	52
X40Cr14g	0,36 to 0,42	≤ 1,00	≤ 1,00	12,5 to 14,5	—	—	—	—	—	—	—	241	1 010	0	180	52
X38CrMo16e,f	0,33 to 0,45	≤ 1,00	≤ 1,50	15,5 to 17,5	0,80 to 1,30	≤ 1,00	—	—	—	—	—	— <sup>e</sup>	—	—	—	— <sup>e</sup>

Elements not quoted in this table shall not be intentionally added to the steel without the agreement of the purchaser, other than for the purpose of finishing the heat. All reasonable precautions shall be taken to prevent the addition from scrap or other materials used in manufacture, of such elements which affect the hardenability, mechanical properties and applicability.

<sup>a</sup> For all steels: phosphorus ≤ 0,030 % and sulfur ≤ 0,030 % (see, however, footnote F).  
<sup>b</sup> Hardness in the cold drawn condition (+A +C) may be 20 HBW higher than in the annealed condition (+A).  
<sup>c</sup> Quenching medium: A = air, O = oil, W = water.  
<sup>d</sup> This material when carburized, quenched and tempered should achieve a surface hardness of 60 HRC.  
<sup>e</sup> This steel is normally supplied in the quenched and tempered condition with a hardness of approximately 300 HBW.  
<sup>f</sup> By agreement, sulfur may be increased to between 0,050 % and 0,100 % and Ni may be omitted.  
<sup>g</sup> This steel may also be supplied in the pre-heated condition with a hardness of approximately 300 HBW.

Table 5 — Permissible deviations between specified cast analysis and product analysis for alloy cold-work tool steels (see Table 4)

Steel name	Permissible deviations <sup>a</sup> , mass fraction %										
	C	Si	Mn	P	S	Cr	Mo	Ni	V	W	
105V	±0,03	±0,03	±0,04	+0,005	+0,005	—	—	—	±0,02	—	
50WCrV8	±0,03	±0,05	±0,04	+0,005	+0,005	±0,05	—	—	±0,02	±0,07	
60WCrV8	±0,03	±0,05	±0,04	+0,005	+0,005	±0,05	—	—	±0,02	±0,07	
102Cr6	±0,03	±0,03	±0,04	+0,005	+0,005	±0,07	—	—	—	—	
21MnCr5	±0,03	±0,03	±0,08	+0,005	+0,005	±0,05	—	—	—	—	
70MnMoCr8	±0,03	±0,03	±0,08	+0,005	+0,005	±0,05	±0,05	—	—	—	
90MnCrV8	±0,03	±0,03	±0,08	+0,005	+0,005	±0,05	—	—	±0,02	—	
95MnCrW5	±0,03	±0,03	±0,06	+0,005	+0,005	±0,05	—	—	±0,02	±0,04	
X100CrMoV5	±0,03	±0,03	±0,04	+0,005	+0,005	±0,10	±0,05	—	±0,03	—	
X153CrMoV12	±0,04	±0,03	±0,04	+0,005	+0,005	±0,15	±0,05	—	±0,04	—	
X210Cr12	±0,05	±0,03	±0,04	+0,005	+0,005	±0,15	—	—	—	—	
X210CrW12	±0,05	±0,03	±0,04	+0,005	+0,005	±0,15	—	—	—	±0,04	
35CrMo7	±0,03	±0,03	±0,04	+0,005	+0,005	±0,07	±0,05	—	—	—	
40CrMnNiMo8-6-4 <sup>b</sup>	±0,03	±0,03	±0,08	+0,005	+0,005	±0,07	±0,03	±0,07	—	—	
45NiCrMo16	±0,03	±0,03	±0,04	+0,005	+0,005	±0,07	±0,03	±0,07	—	—	
X40Cr14	±0,03	±0,05	±0,04	+0,005	+0,005	±0,15	—	—	—	—	
X38CrMo16	±0,03	±0,05	±0,04	+0,005	+0,005	±0,15	±0,05	+0,07	—	—	

<sup>a</sup> The deviations, other than when maxima only are specified, apply either above or below the specified limits of the range but not both above and below for the same element from different sample products from the same cast. When maxima only are specified the deviations are positive only. The values are valid only if the samples are selected in accordance with ISO 14284, so that they represent the average composition of the cross-section of the product.

<sup>b</sup> If a range for the sulfur content of this grade is agreed, the permissible deviation shall be ±0,010 %.

**Table 6 — Chemical composition (cast analysis) for hot-work tool steels, annealed hardness, austenitizing temperature and hardness in the quenched and tempered condition**

Steel name	Mass fraction <sup>a</sup> %										Hardness (annealed) <sup>b</sup> +A HBW max.	Hardening test		
	C	Si	Mn	Cr	Mo	V	W	Others	Austenitizing temperature °C (±10 °C)	Quenching medium <sup>c</sup>		Tempering temperature °C (±10 °C)	Hardness HRC min.	
55NiCrMoV7h <sup>e</sup>	0,50 to 0,60	0,10 to 0,40	0,60 to 0,90	0,80 to 1,20	0,35 to 0,55	0,05 to 0,15	—	Ni: 1,50 to 1,80	850	0	500	42f		
32CrMoV12-28	0,28 to 0,35	0,10 to 0,40	0,15 to 0,45	2,70 to 3,2	2,50 to 3,00	0,40 to 0,70	—	—	1 040	0	550	46		
X37CrMoV5-1	0,33 to 0,41	0,80 to 1,20	0,25 to 0,50	4,8 to 5,5	1,10 to 1,50	0,30 to 0,50	—	—	1 020	0	550	48		
X38CrMoV5-3	0,35 to 0,40	0,30 to 0,50	0,30 to 0,50	4,8 to 5,2	2,70 to 3,2	0,40 to 0,60	—	—	1 040	0	550	50		
X40CrMoV5-1	0,35 to 0,42	0,80 to 1,20	0,25 to 0,50	4,8 to 5,5	1,20 to 1,50	0,85 to 1,15	—	—	1 020	0	550	50		
50CrMoV13-15	0,45 to 0,55	0,20 to 0,80	0,50 to 0,90	3,0 to 3,5	1,30 to 1,70	0,15 to 0,35	—	—	1 010	0	510	56		
X30WCrV9-3	0,25 to 0,35	0,10 to 0,40	0,15 to 0,45	2,5 to 3,2	—	0,30 to 0,50	8,5 to 9,5	—	1 150	0	600	48		
X35CrWMoV5	0,32 to 0,40	0,80 to 1,20	0,20 to 0,50	4,75 to 5,5	1,25 to 1,60	0,20 to 0,50	1,10 to 1,60	—	1 020	0	550	48		
38CrCoWV18-17-17	0,35 to 0,45	0,15 to 0,50	0,20 to 0,50	4,0 to 4,7	0,30 to 0,50	1,70 to 2,10	3,8 to 4,5	Co: 4,0 to 4,5	1 120	0	600	48		

Elements not quoted in this table shall not be intentionally added to the steel without the agreement of the purchaser, other than for the purpose of finishing the heat. All reasonable precautions shall be taken to prevent the addition from scrap or other materials used in manufacture, of such elements which affect the hardenability, mechanical properties and applicability.

a For all steels (unless otherwise specified), phosphorus ≤ 0.030 % and sulfur ≤ 0.020 %.

b Hardness in the cold drawn condition (+A+C) may be 20 HBW higher than in the annealed condition (+A).

c Quenching medium: 0 = oil. Usual quenching media for tools are air, gas or salt bath.

d The sulfur content for this grade is ≤ 0.030 %.

e For greater dimensions, this steel is normally supplied in the quenched and tempered condition with a hardness of approximately 380 HBW.

f This value applies for smaller dimensions only.

Table 7 — Permissible deviations between specified cast analysis and product analysis for hot-work tool steels (see Table 6)

Steel name	Permissible deviations, mass fraction %										
	C	Si	Mn	P	S	Cr	Mo	Ni	Co	V	W
55NiCrMoV7	±0,02	±0,03	±0,04	+0,005	+0,005	±0,05	±0,04	±0,07	—	±0,02	—
32CrMoV12-28	±0,02	±0,03	±0,04	+0,005	+0,005	±0,10	±0,10	—	—	±0,04	—
X37CrMoV5-1	±0,02	±0,05	±0,04	+0,005	+0,005	±0,10	±0,05	—	—	±0,04	—
X38CrMoV5-3	±0,02	±0,03	±0,04	+0,005	+0,005	±0,10	±0,10	—	—	±0,04	—
X40CrMoV5-1	±0,02	±0,05	±0,04	+0,005	+0,005	±0,10	±0,05	—	—	±0,05	—
50CrMoV13-15	±0,02	±0,05	±0,04	+0,005	+0,005	±0,10	±0,05	—	—	±0,04	—
X30WCrV9-3	±0,02	±0,03	±0,04	+0,005	+0,005	±0,10	—	—	—	±0,04	±0,10
X35CrWMoV5	±0,02	±0,05	±0,04	+0,005	+0,005	±0,10	±0,05	—	—	±0,04	±0,07
38CrCoWV18-17-17	±0,02	±0,03	±0,04	+0,005	+0,005	±0,10	±0,04	—	±0,10	±0,10	±0,10

NOTE The deviations, other than when maxima only are specified, apply either above or below the specified limits of the range but not both above and below for the same element from different sample products from the same cast. When maxima only are specified the deviations are positive only. The values are valid only if the samples are selected in accordance with ISO 14284, so that they represent the average composition of the cross-section of the product.

**Table 8 — Chemical composition (cast analysis) for high-speed tool steels, annealed hardness, austenitizing temperature and hardness in the hardened and tempered condition**

Steel name	Mass fraction <sup>a, b, %</sup>										Hardness (annealed) <sup>c</sup> +A HBW max.	Hardening tests			Hardness HRC min.
	C	Si max.	Co	Cr	Mo	V	W	Austenitizing Temperature °C (±10 °C)	Quenching medium <sup>d</sup>	Tempering temperature °C (±10 °C) min.					
HS0-4-1	0,77 to 0,85	0,65	—	3,9 to 4,4	4,0 to 4,5	0,90 to 1,10	—	—	—	—	1 120	—	560	60	
HS1-4-2	0,85 to 0,95	0,65	—	3,6 to 4,3	4,1 to 4,8	1,70 to 2,20	0,80 to 1,40	—	—	—	1 180	—	560	63	
HS18-0-1	0,73 to 0,83	0,45	—	3,8 to 4,5	—	1,00 to 1,20	17,2 to 18,7	—	—	—	1 260	—	560	63	
HS2-9-2	0,95 to 1,05	0,70	—	3,5 to 4,5	8,2 to 9,2	1,70 to 2,20	1,50 to 2,10	—	—	—	1 200	—	560	64	
HS1-8-1	0,77 to 0,87	0,70	—	3,5 to 4,5	8,0 to 9,0	1,00 to 1,40	1,40 to 2,00	—	—	—	1 190	—	560	63	
HS3-3-2	0,95 to 1,03	0,45	—	3,8 to 4,5	2,50 to 2,90	2,20 to 2,50	2,70 to 3,00	—	—	—	1 190	—	560	62	
HS6-5-2	0,80 to 0,88	0,45	—	3,8 to 4,5	4,7 to 5,2	1,70 to 2,10	5,9 to 6,7	—	—	—	1 220	—	560	64	
HS6-5-2Cf	0,86 to 0,94	0,45	—	3,8 to 4,5	4,7 to 5,2	1,70 to 2,10	5,9 to 6,7	—	—	—	1 210	—	560	64	
HS6-5-3	1,15 to 1,25	0,45	—	3,8 to 4,5	4,7 to 5,2	2,70 to 3,2	5,9 to 6,7	—	—	—	1 200	—	560	64	
HS6-5-3C	1,25 to 1,32	0,70	—	3,8 to 4,5	4,7 to 5,2	2,70 to 3,2	5,9 to 6,7	—	—	—	1 180	—	560	64	
HS6-6-2	1,00 to 1,10	0,45	—	3,8 to 4,5	5,5 to 6,5	2,30 to 2,60	5,9 to 6,7	—	—	—	1 200	—	560	64	
HS6-5-4	1,25 to 1,40	0,45	—	3,8 to 4,5	4,2 to 5,0	3,7 to 4,2	5,2 to 6,0	—	—	—	1 210	—	560	64	
HS6-5-2-5f	0,87 to 0,95	0,45	4,5 to 5,0	3,8 to 4,5	4,7 to 5,2	1,70 to 2,10	5,9 to 6,7	—	—	—	1 210	—	560	64	
HS6-5-3-8	1,23 to 1,33	0,70	8,0 to 8,8	3,8 to 4,5	4,7 to 5,3	2,70 to 3,2	5,9 to 6,7	—	—	—	1 180	—	560	65	
HS10-4-3-10	1,20 to 1,35	0,45	9,5 to 10,5	3,8 to 4,5	3,2 to 3,9	3,00 to 3,5	9,0 to 10,0	—	—	—	1 230	—	560	66	
HS2-9-1-8	1,05 to 1,15	0,70	7,5 to 8,5	3,5 to 4,5	9,0 to 10,0	0,90 to 1,30	1,20 to 1,90	—	—	—	1 190	—	550	66	

Elements not quoted in this table shall not be intentionally added to the steel without the agreement of the purchaser, other than for the purpose of finishing the heat. All reasonable precautions shall be taken to prevent the addition from scrap or other materials used in manufacture, of such elements which affect the hardenability mechanical properties and applicability.

a Maximum 0,40 % Mn unless otherwise specified (see footnote f).

b Maximum 0,030 % P and S each.

c Hardness in the annealed plus cold drawn condition (+A+C) may be 50 HBW and hardness in the annealed plus cold rolled condition (+A+CR) may be 70 HBW higher than in the annealed condition (+A).

d For the reference hardening test either oil or salt bath: in cases of dispute, however, only oil. Usual quenching media in practice are air, gas or salt bath.

e See B.3.

f A sulphur range of 0,060 % to 0,150 % may be agreed at the time of enquiry and order for this grade. In this case a max. of 0,80 % Mn applies.

Table 9 — Permissible deviations between specified cast analysis and product analysis for high-speed tool steels (see Table 8)

Steel name	Mass fraction <sup>a,b</sup> , %										
	C	Si	Mn	P	S	Co	Cr	Mo	V	W	
HSO-4-1	±0,03	+0,03	+0,04	+0,005	+0,005	—	±0,10	±0,10	±0,05	—	
HSI-4-2	±0,03	+0,03	+0,04	+0,005	+0,005	—	±0,10	±0,10	±0,07	±0,10	
HSI8-0-1	±0,03	+0,03	+0,04	+0,005	+0,005	—	±0,10	—	±0,05	±0,20	
HS2-9-2	±0,03	+0,03	+0,04	+0,005	+0,005	—	±0,10	±0,10	±0,07	±0,10	
HSI-8-1	±0,03	+0,03	+0,04	+0,005	+0,005	—	±0,10	±0,10	±0,05	±0,10	
HS3-3-2	±0,03	+0,03	+0,04	+0,005	+0,005	—	±0,10	±0,10	±0,10	±0,10	
HS6-5-2	±0,03	+0,03	+0,04	+0,005	+0,005	—	±0,10	±0,10	±0,07	±0,10	
HS6-5-2C	±0,03	+0,03	+0,04	+0,005	+0,005	—	±0,10	±0,10	±0,07	±0,10	
HS6-5-3	±0,03	+0,03	+0,04	+0,005	+0,005	—	±0,10	±0,10	±0,10	±0,10	
HS6-5-3C	±0,04	+0,03	+0,04	+0,005	+0,005	—	±0,10	±0,10	±0,10	±0,10	
HS6-6-2	±0,03	+0,03	+0,04	+0,005	+0,005	—	±0,10	±0,10	±0,10	±0,10	
HS6-5-4	±0,04	+0,03	+0,04	+0,005	+0,005	—	±0,10	±0,10	±0,10	±0,10	
HS6-5-2-5	±0,03	+0,03	+0,04	+0,005	+0,005	±0,10	±0,10	±0,10	±0,07	±0,10	
HS6-5-3-8	±0,04	+0,03	+0,04	+0,005	+0,005	±0,10	±0,10	±0,10	±0,10	±0,10	
HS10-4-3-10	±0,03	+0,03	+0,04	+0,005	+0,005	±0,15	±0,10	±0,10	±0,10	±0,10	
HS2-9-1-8	±0,03	+0,03	+0,04	+0,005	+0,005	±0,10	±0,10	±0,10	±0,05	±0,10	

<sup>a</sup> The deviations, other than when maxima only are specified, apply either above or below the specified limits of the range but not both above and below for the same element from different sample products from the same cast. When maxima only are specified the deviations are positive only. The values are valid only if the samples are selected in accordance with ISO 14284, so that they represent the average composition of the cross-section of the product.

<sup>b</sup> If a range for the sulfur content is agreed, the permissible deviation shall be ±0,010 %.



## 11 Location of test pieces in the hardening test

### 11.1 Product diameter or thickness $\geq 15$ mm

The test piece shall, according to the choice of the manufacturer,

- be identical with the test sample, as demonstrated in [Figure 1 a\)](#),
- be taken from the sample by one cut as demonstrated in [Figure 1 b\)](#), or
- be taken from the sample by two cuts as demonstrated in [Figure 1 c\)](#).

Dimensions in millimetres

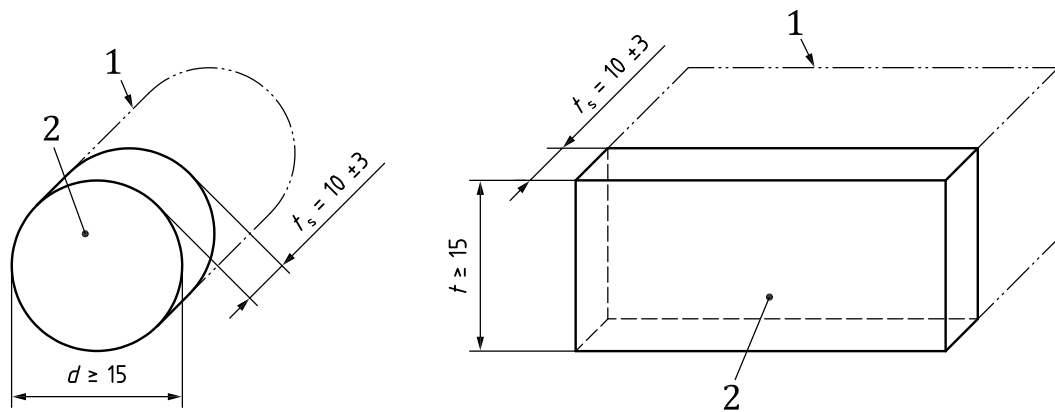

(a) Test piece identical with the test sample

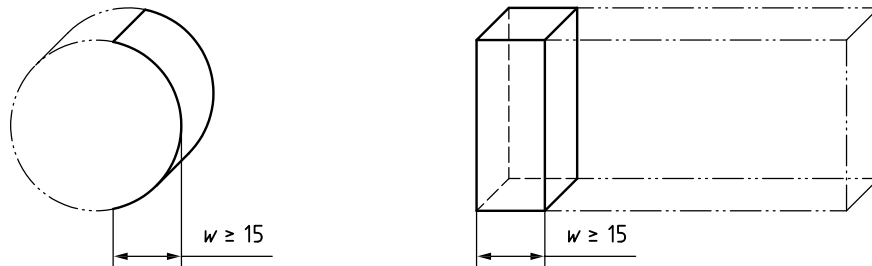

(b) Test piece taken from the sample by one cut

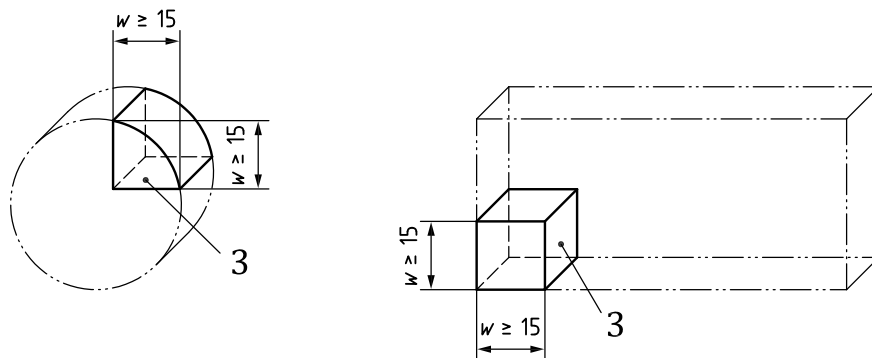

(c) Test piece taken from the sample by two cuts

Key

- 1 product
- 2 sample
- 3 test piece

Figure 1 — Location of test pieces in the hardening test — Product diameter or thickness  $\geq 15$  mm

11.2 Product diameter or thickness  $< 15$  mm

The test piece shall, according to the choice of the manufacturer,

- a) be identical with the test sample, as shown in [Figure 2 a](#)), or
- b) be taken from rectangular samples by one cut as demonstrated in [Figure 2 b](#)).

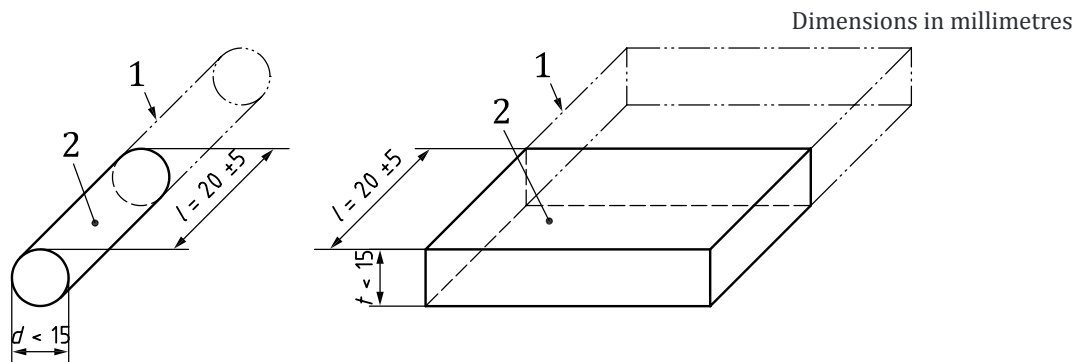

(a) Test piece identical with the test sample

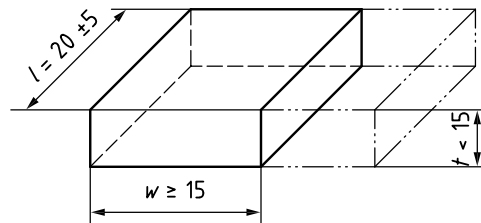

(b) Test piece taken from rectangular samples by one cut

Key

- |           |                        |
|-----------|------------------------|
| 1 product | $d$ diameter           |
| 2 sample  | $l$ length             |
|           | $t$ thickness          |
|           | $t_s$ sample thickness |
|           | $w$ width              |

Figure 2 — Location of test pieces in the hardening test — Product diameter or thickness  $< 15$  mm

## Annex A (informative)

### Hardness-tempering temperature curves

The hardness-tempering temperature curves of the steels are given for guidance in [Figures A.1](#) to [A.4](#). In these figures, the austenitizing temperature and the quenching medium (W = water, O = oil, A = air) are mentioned.

NOTE The hardness-tempering temperature-curve for a certain steel type can vary to a considerable extent depending on the chemical composition of the cast, the hardening conditions and the tempering conditions. Consequently, the curves in [Figures A.1](#) to [A.4](#), which originate from data from different sources, can, for the time being, give only a rough guide to the tempering behaviour of the steels. They are assumed to apply with the above reservations for test pieces that have been tempered at the relevant tempering temperature but that, in all other respects, have been prepared according to the conditions for the hardening test (see [B.3](#)). When applying the curves for an estimation of the hardness that can be expected in quenched and tempered tools, it is taken into account that the optimum heat-treatment conditions for the tools are not necessarily identical with those specified for the test pieces and also that the times for heating given in [B.3](#) are not valid for thicker tools.

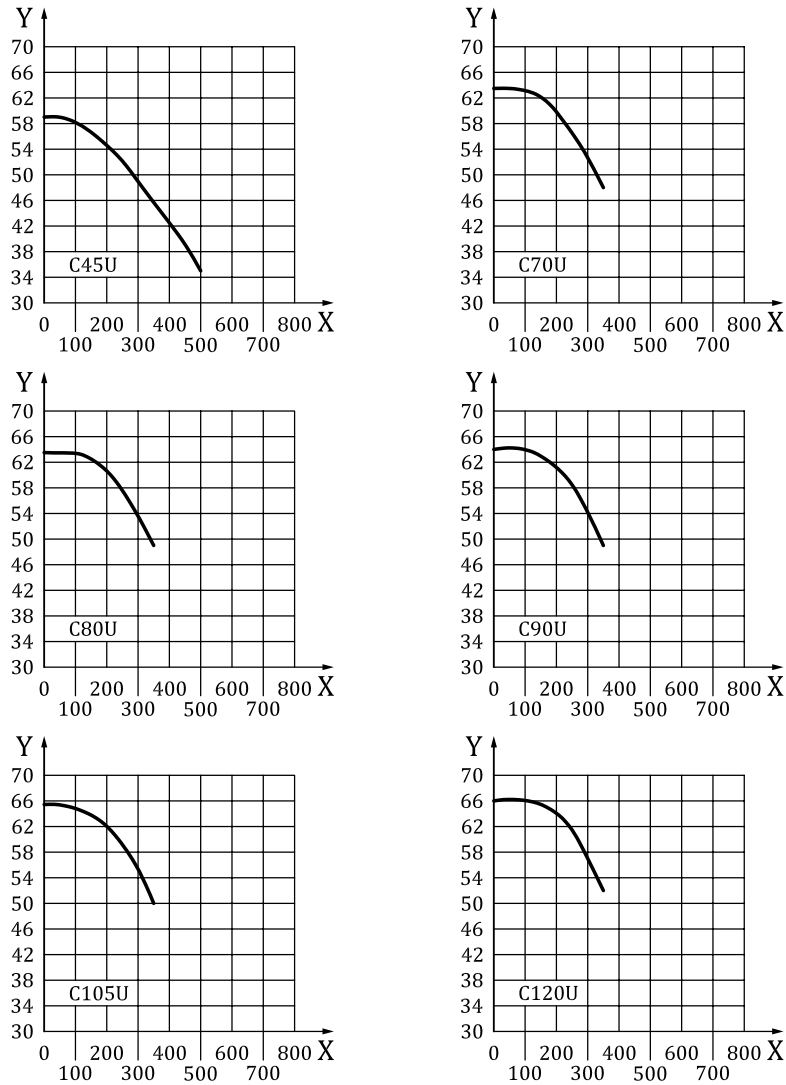

**Key**

X tempering temperature, °C

Y hardness HRC

Heat treatment C45U: 810 °C/W, C70U: 800°C/W, C80U: 790°C/W, C90U: 780 °C/W, C105U: 780 °C/W, C120U: 770 °C/W.

**Figure A.1 — Hardness-tempering temperature curves for unalloyed cold-work tool steels (see [Table 2](#))**

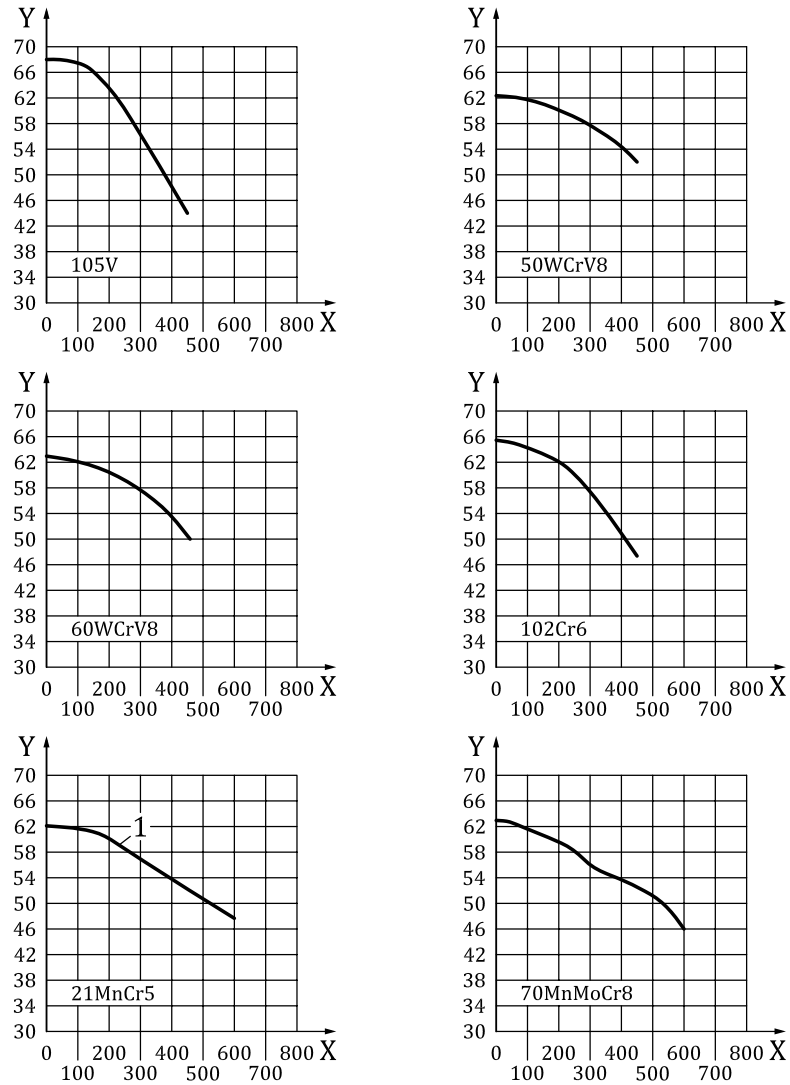

**Key**

X tempering temperature, °C

Y hardness HRC

1 hardness of the case hardened surface

Heat treatment 105V: 790 °C/W, 50WCrV8: 920 °C/O, 60WCrV8: 910 °C/O, 102Cr6: 84 °C/O, 21MnCr5: 820 °C/O, 70MnMoCr8: 835 °C/O.

**Figure A.2 — Hardness-tempering temperature curves for alloyed cold-work tool steels  
(see Table 4)**

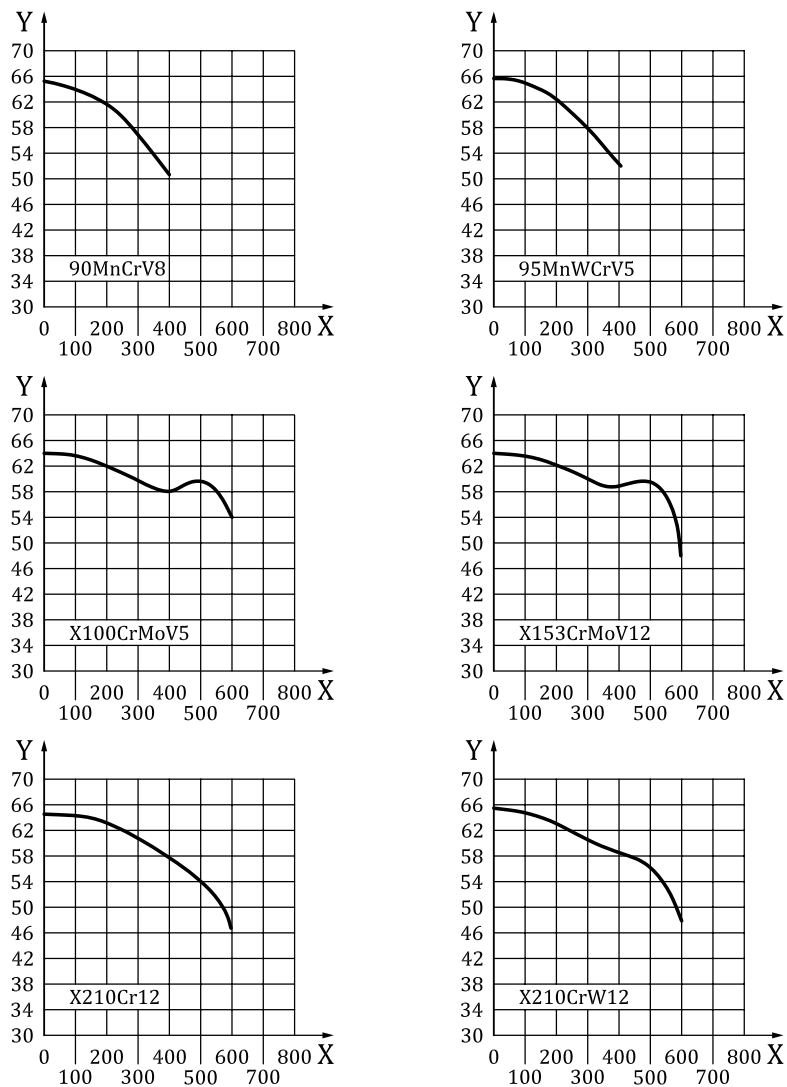

**Key**

X tempering temperature, °C

Y hardness HRC

Heat treatment 90MnCrV8: 790 °C/O, 95MnWCrV5: 800 °C/O, X100CrMoV5: 970 °C/AW, X153CrMoV12: 1 020 °C/A, X210Cr12: 970 °C/O, X210CrW12: 970 °C/O

**Figure A.2 — (continued)**

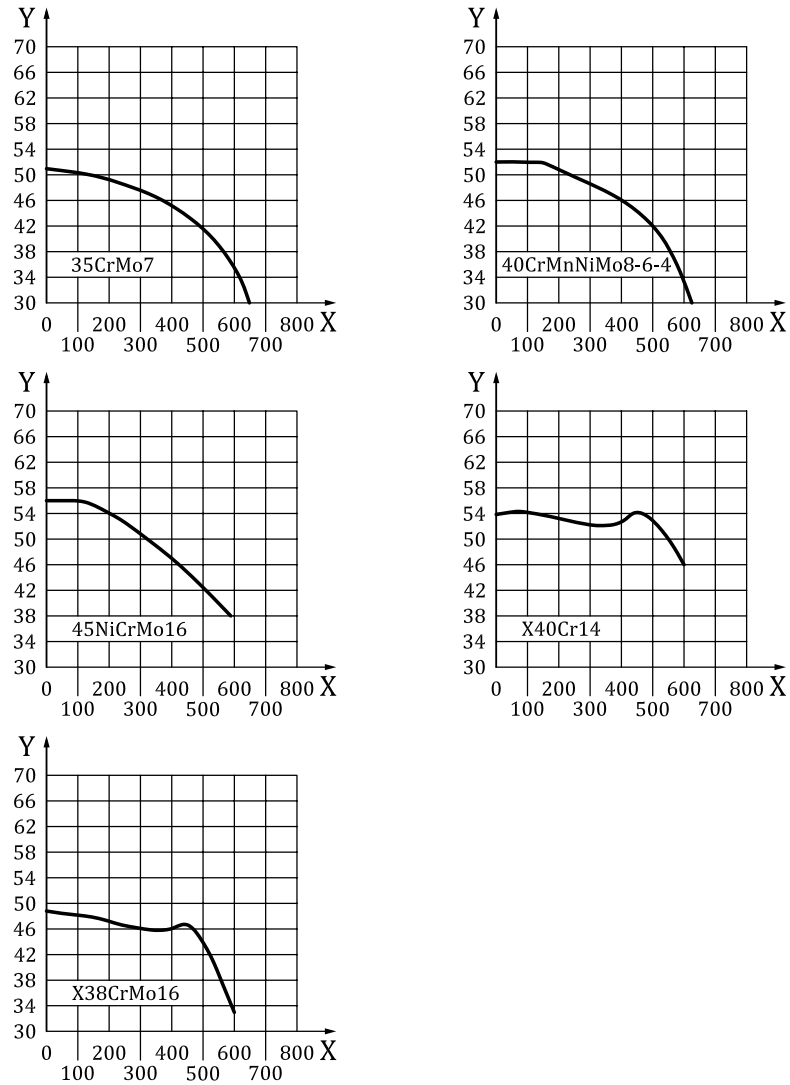

**Key**

X tempering temperature, °C

Y hardness HRC

Heat treatment 35CrMo7: see [Table 4](#) footnote e, 40CrMnNiMo8-6-4: see [Table 4](#) footnote e, 45NiCrMo16: 850 °C/W, X40Cr14: 1 010 °C/W, X38CrMo16: see [Table 4](#) footnote e.

**Figure A.2 — (continued)**

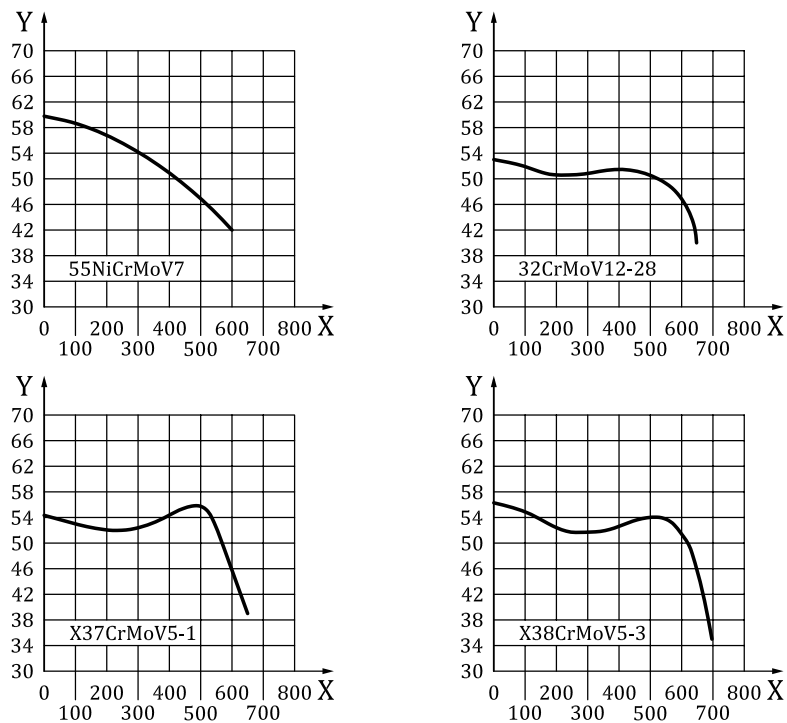

**Key**

X tempering temperature, °C

Y hardness HRC

Heat treatment 55NiCrMoV7: 850 °C/O, 32CrMoV12-28: 1 040 °C/O, X37CrMoV5-1: 1 020 °C/O, X38CrMoV5-3: 1 040 °C/O.

**Figure A.3 — Hardness-tempering temperature curves for hot-work tool steels (see [Table 6](#))**



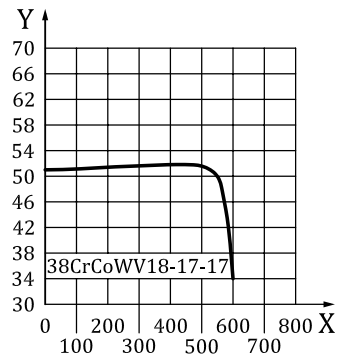
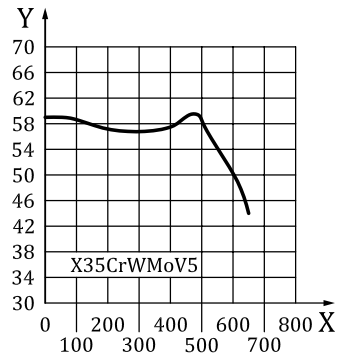
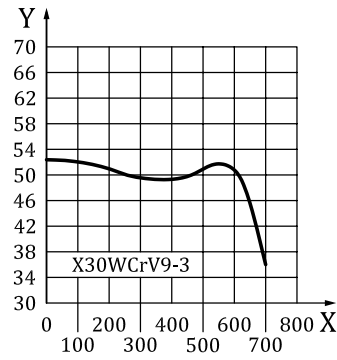
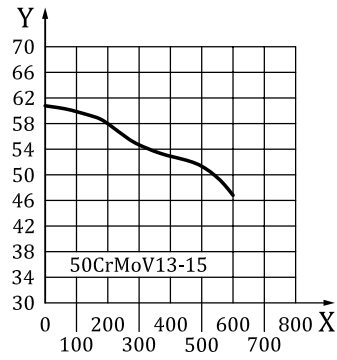
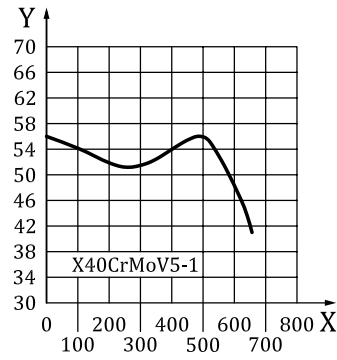

**Key**

X tempering temperature, °C

Y hardness HRC

Heat treatment X40CrMoV5-1: 1 020 °C/O, 50CrMoV13-15: 1 010 °C/O, X30WCrV9-3: 1 150 °C/O, X35CrWMoV5: 1 020 °C/O, 38CrCoWV18-17-17: 1 120 °C/O.

**Figure A.3 — (continued)**

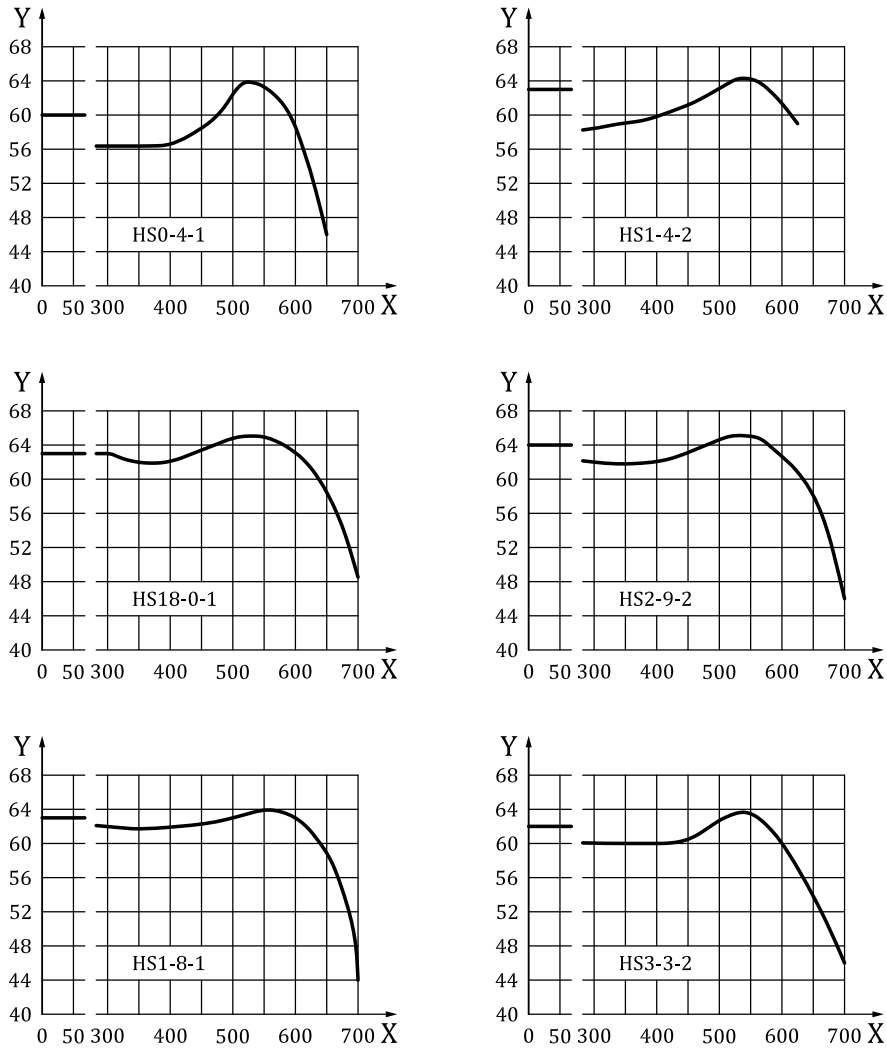

**Key**

X tempering temperature, °C

Y hardness HRC

Heat treatment HS0-4-1: 1 120 °C/O, HS1-4-2: 1 180 °C/O, HS18-0-1: 1 260 °C/O, HS2-9-2: 1 200 °C/O, HS1-8-1: 1 190 °C/O, HS3-3-2: 1 190 °C/O.

**Figure A.4 — Hardness-tempering temperature curves for high-speed tool steels (see [Table 8](#))**

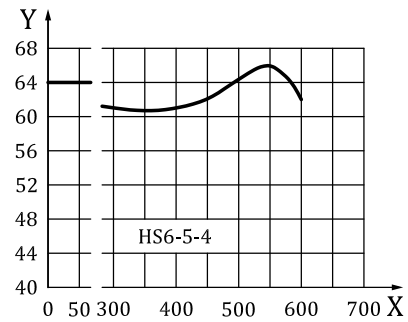
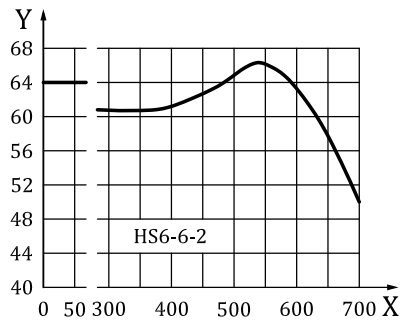
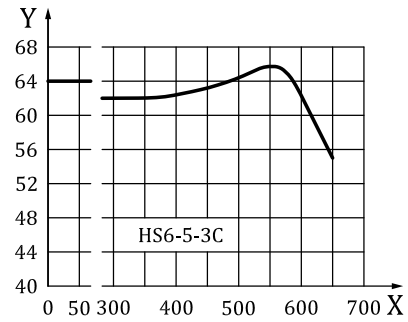
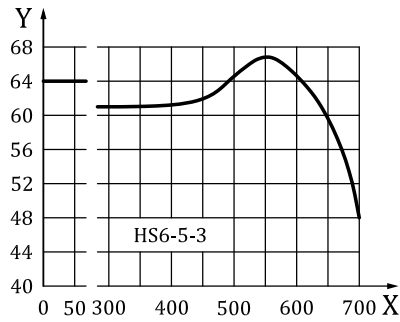
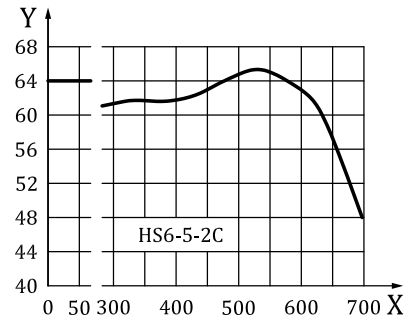
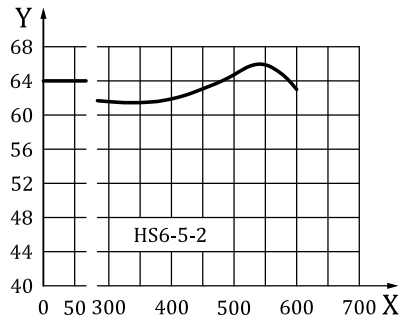

**Key**

X tempering temperature, °C

Y hardness HRC

Heat treatment HS6-5-2: 1 220 °C/O, HS6-5-2 C: 1210 °C/O, HS6-5-3: 1 200 °C/O, HS6-5-3 C: 1180 °C/O, HS6-6-2: 1 200 °C/O, HS6-5-4: 1 210 °C/O.

**Figure A.4 — (continued)**

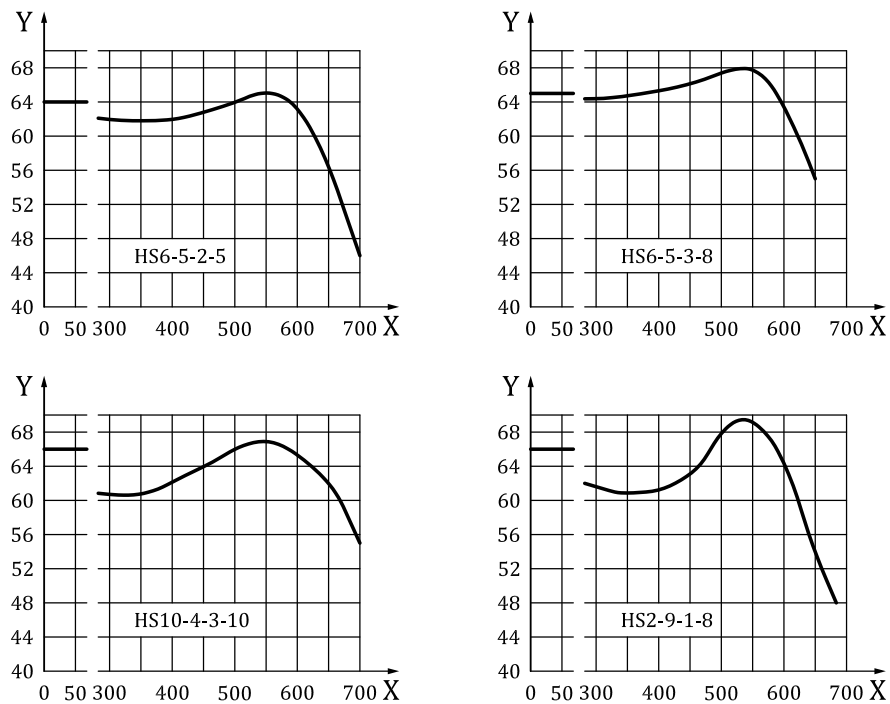

**Key**

X tempering temperature, °C

Y hardness HRC

Heat treatment HS6-5-2-5: 1 210 °C/O, HS6-5-3-8 C: 1 180 °C/O, HS10-4-3-10: 1 230 °C/O, HS2-9-1-8 C: 1 190 °C/O.

**Figure A.4 — (continued)**

## Annex B (normative)

### Supplementary or special requirements

#### B.1 General

One or more of the following supplementary or special requirements shall be applied, but only when specified in the enquiry and order. Where necessary, details of these requirements shall be agreed upon by the manufacturer and the purchaser at the time of enquiry and order.

#### B.2 Product analysis

One product analysis shall be carried out per cast for elements for which values are specified for the cast analysis of the steel type concerned.

The conditions for sampling shall be in accordance with ISO 14284. In the case of dispute about the analytical method, the chemical composition shall be determined in accordance with a reference method taken from one of the International Standards listed in ISO/TR 9769.

#### B.3 Verification of the minimum hardness in the hardening test

The minimum hardness specified for the hardening test in [Tables 2, 4, 6 and 8](#) shall be verified under the following conditions.

For the hardening test, one test piece shall be cut off from the sample product in accordance with the conditions indicated in [Figures 1 and 2](#).

The test pieces shall be hardened and tempered under the conditions given in [Tables 2, 4, 6 and 8](#) and under conditions that avoid decarburization. Samples of products in the untreated condition may, at the discretion of the manufacturer, be subjected to an annealing treatment before hardening and tempering is carried out. The total heating time of test pieces in a salt bath shall be as given in Table B.1.

If the test pieces are not heated in a salt bath the heating time shall be extended accordingly.

The cut surface shall be prepared and the hardness shall be measured in accordance with ISO 6508-1.

**Table B.1 — Total heating time of test pieces in a salt bath**

Nature of steel	Total heating time for	
	hardening min	tempering min
Cold- or hot-work steels ( <a href="#">Tables 2, 4 and 6</a> )	25 ± 1	60
High-speed steels ( <a href="#">Table 8</a> )	3	minimum 2 periods of 60 each

#### B.4 Structure

The structure shall comply with the requirements agreed at the time of enquiry and order.

## **B.5 Surface quality**

The surface quality shall comply with the requirements agreed at the time of enquiry and order.

In addition, the details for sampling and for preparation of the test pieces for testing the surface quality shall be agreed at the time of enquiry and order.

## **B.6 Special dimensional inspection**

An agreed number of products shall be inspected for their shape and dimensions.

## **B.7 Non-destructive tests**

The products shall be non-destructively tested under conditions and to an acceptance standard agreed at the time of enquiry and order.

For plates, ISO 17577 acceptance class B1 shall apply unless otherwise agreed.

## **B.8 Tolerance on mass**

The mass tolerances shall comply with the requirements agreed at the time of enquiry and order.

The following density values should be used as a basis for calculating the nominal mass of products.

For steels with about 18 % W	8,7 kg/dm <sup>3</sup>
For steels with about 12 % W	8,4 kg/dm <sup>3</sup>
For steels with about 6 % W	8,2 kg/dm <sup>3</sup>
For steels with about 3 % W (including steel 60WCrV8)	8,0 kg/dm <sup>3</sup>
For steels with about 12 % Cr	7,6 kg/dm <sup>3</sup>
For all other steels	7,85 kg/dm <sup>3</sup>

## **B.9 Special agreements for marking**

The products shall be marked as agreed upon at the time of enquiry and order.

## Annex C (informative)

### Designations of comparable steels

**Table C.1 — Designations of the steels given in [Tables 2, 4, 6](#) and [8](#) and of comparable grades covered in various regional or national standards or designation systems**

Steel designations in accordance with		
This document	EN 10027-2	JIS
Non-alloy cold-work tool steels		
C45U	1.1730	—
C70U	1.1520	SK65
C80U	1.1525	SK75
C90U	1.1535	SK85, SK95
C105U	1.1545	SK105
C120U	1.1555	SK120
Alloy cold-work tool steels		
105V	1.2834	SKS43
5WCrV8	1.2549	—
60WCrV8	1.2550	—
102Cr6	1.2067	—
21MnCr5	1.2162	—
70MnMoCr8	1.2824	—
90MnCrV8	1.2842	—
95MnWCr5	1.2825	—
X100CrMoV5	1.2363	SKD12
X153CrMoV12	1.2379	—
X210Cr12	1.2080	—
X210CrW12	1.2436	—
35CrM07	1.2302	—
40CrMnNiMo8-6-4	1.2738	—
45NiCrMo16	1.2767	—
X40Cr14	1.2083	—
X38CrMo16	1.2316	—
Hot-work tool steels		
55NiCrMoV7	1.2714	SKT4
32CrMoV12-28	1.2365	SKD7
X37CrMoV5-1	1.2343	SKD6
X38CrMoV5-3	1.2367	—
X40CrMoV5-1	1.2344	SKD61
50CrMoV13-15	1.2355	—
X30WCrV9-3	1.2581	SKD5
X35CrWMoV5	1.2605	SKD62

**Table C.1** (continued)

Steel designations in accordance with		
This document	EN 10027-2	JIS
38CrCoWV18-17-17	1.2661	SKD8
High-speed tool steels		
HS0-4-1	1.3325	—
HS1-4-2	1.3326	—
HS18-0-1	1.3355	SKH2
HS2-9-2	1.3348	SKH58
HS1-8-1	1.3327	—
HS3-3-2	1.3333	—
HS6-5-2	1.3339	SKH51
HS6-5-2C	1.3343	—
HS6-5-3	1.3344	SKH53
HS6-5-3C	1.3345	—
HS6-6-2	1.3350	SKH52
HS6-5-4	1.3351	SKH54
HS6-5-2-5	1.3243	SKH55
HS6-5-3-8	1.3244	—
HS10-4-3-10	1.3207	SKH57
HS2-9-1-8	1.3247	SKH59



## Bibliography

- [1] ISO 4955, *Heat-resistant steels*
- [2] EN 10027-2, *Designation systems for steels — Part 2: Numerical system*

**National Annex A**  
*(National Foreword)*

**A-1 BIS CERTIFICATION MARKING**

The product(s) conforming to the requirements of this standard may be certified as per the conformity assessment schemes under the provisions of the *Bureau of Indian Standards Act, 2016* and the Rules and Regulations framed thereunder, and the products may be marked with the standard mark.



## Bureau of Indian Standards

BIS is a statutory institution established under the *Bureau of Indian Standards Act, 2016* to promote harmonious development of the activities of standardization, marking and quality certification of goods and attending to connected matters in the country.

### Copyright

BIS has the copyright of all its publications. No part of these publications may be reproduced in any form without the prior permission in writing of BIS. This does not preclude the free use, in the course of implementing the standard, of necessary details, such as symbols and sizes, type or grade designations. Enquiries relating to copyright be addressed to the Head (Publication & Sales), BIS.

### Review of Indian Standards

Amendments are issued to standards as the need arises on the basis of comments. Standards are also reviewed periodically; a standard along with amendments is reaffirmed when such review indicates that no changes are needed; if the review indicates that changes are needed, it is taken up for revision. Users of Indian Standards should ascertain that they are in possession of the latest amendments or edition by referring to the website-[www.bis.gov.in](http://www.bis.gov.in) or [www.standardsbis.in](http://www.standardsbis.in).

This Indian Standard has been developed from Doc No.: MTD 16 (19495).

### Amendments Issued Since Publication

Amend No.	Date of Issue	Text Affected

## BUREAU OF INDIAN STANDARDS

### Headquarters:

Manak Bhavan, 9 Bahadur Shah Zafar Marg, New Delhi 110002

Telephones: 2323 0131, 2323 3375, 2323 9402

Website: [www.bis.gov.in](http://www.bis.gov.in)

### Regional Offices:

	Telephones
Central : 601/A, Konnectus Tower -1, 6 <sup>th</sup> Floor, DMRC Building, Bhavbhuti Marg, New Delhi 110002	{ 2323 7617
Eastern : 8 <sup>th</sup> Floor, Plot No 7/7 & 7/8, CP Block, Sector V, Salt Lake, Kolkata, West Bengal 700091	{ 2367 0012 2320 9474
Northern : Plot No. 4-A, Sector 27-B, Madhya Marg, Chandigarh 160019	{ 265 9930
Southern : C.I.T. Campus, IV Cross Road, Taramani, Chennai 600113	{ 2254 1442 2254 1216
Western : Plot No. E-9, Road No.-8, MIDC, Andheri (East), Mumbai 400093	{ 2821 8093

**Branches :** AHMEDABAD. BENGALURU. BHOPAL. BHUBANESHWAR. CHANDIGARH. CHENNAI. COIMBATORE. DEHRADUN. DELHI. FARIDABAD. GHAZIABAD. GUWAHATI. HIMACHAL PRADESH. HUBLI. HYDERABAD. JAIPUR. JAMMU & KASHMIR. JAMSHEDPUR. KOCHI. KOLKATA. LUCKNOW. MADURAI. MUMBAI. NAGPUR. NOIDA. PANIPAT. PATNA. PUNE. RAIPUR. RAJKOT. SURAT. VISAKHAPATNAM.